

MOROSINI<sup>®</sup>  
luce & design



*EviStyle*<sup>®</sup>  
Passion for light

MOROSINI®  
luce & design



*EviStyle*®  
Passion for light

ALASKA\_154      FOG PLISSÈ\_116      SANTRAL\_48  
 ARCHETYPE\_12      IN & OUT\_142      SUNRISE ECO\_164  
 CUEVA\_42      MIKADO\_60      VANE\_22  
 DIAMOND\_136      MIKADO ZERO\_76  
 DICE\_148      PANK\_84      LEGENDA\_318  
 EGG\_158      RAMETTO\_28  
 FOG\_102      RIBBON\_126

## DESIGNERS



massimo  
TONETTO



marco  
TAIETTA



filippo  
MAMBRETTI



andrea  
LAZZARI



tiziano  
MAFFIONE

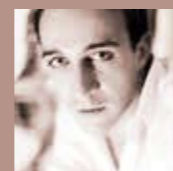

sandro  
SANTANTONIO



romani saccani  
ARCHITETTI  
ASSOCIATI



CHIARAMONTE MARIN

BIA\_184      SAN MARCO\_278      LEGENDA\_318  
 GADORA\_244      TEARS\_270  
 GADORA CHIC\_258      TESSUTI\_302  
 MEMORIA\_208      TROTTOLA\_174  
 MINERVA\_194      VINTAGE\_224  
 RONDÒ\_294

## DESIGNERS



simone  
BELLAN



andrea  
LAZZARI



romani saccani  
ARCHITETTI  
ASSOCIATI



stefano  
MANDRUZZATO



dima  
LOGINOFF











manuel borri  
DIAGORA DESIGN

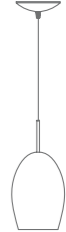
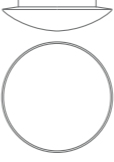

CHIARAMONTE MARIN

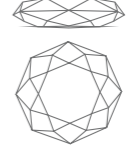

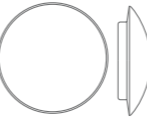
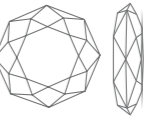
VISUAL INDEX\_  
MOROSINI  
EVISTYLE

	ALASKA pag. 154	ARCHETYPE pag. 12	CUEVA pag. 42	DIAMOND pag. 136	DICE pag. 148	EGG pag. 158
SOSPENSIONI/ LAMPADARI Pendants/ Chandeliers						
SOFFITTO Ceiling lamps						
PARETE Wall lamps						
TAVOLO Table lamps						
TERRA Floor lamps						

MOROSINI

FOG  
pag. 102

FOG PLISSÈ  
pag. 116

IN & OUT  
pag. 142

MIKADO  
pag. 60

MIKADO ZERO  
pag. 76

PANK  
pag. 84

SOSPENSIONI/  
LAMPADARI  
Pendants/  
Chandeliers

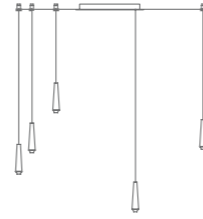
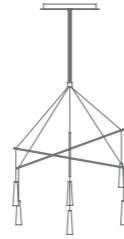

SOFFITTO  
Ceiling lamps

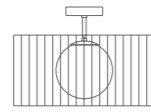
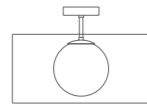

PARETE  
Wall lamps

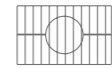
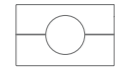

TAVOLO  
Table lamps

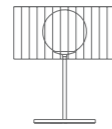
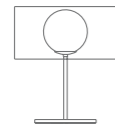

TERRA  
Floor lamps



MOROSINI

RAMETTO  
pag. 28

RIBBON  
pag. 126

SANTRAL  
pag. 48

SUNRISE ECO  
pag. 164

VANE  
pag. 22

SOSPENSIONI/  
LAMPADARI  
Pendants/  
Chandeliers

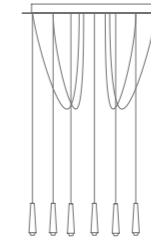

SOFFITTO  
Ceiling lamps

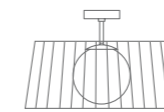

PARETE  
Wall lamps

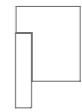
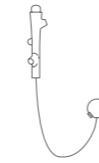

TAVOLO  
Table lamps

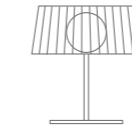

TERRA  
Floor lamps



EVISTYLE

BIA pag. 184	GADORA pag. 244	GADORA CHIC pag. 258	MEMORIA pag. 208	MINERVA pag. 194	RONDÒ pag. 294
-----------------	--------------------	-------------------------	---------------------	---------------------	-------------------

SOSPENSIONI/  
LAMPADARI  
Pendants/  
Chandeliers

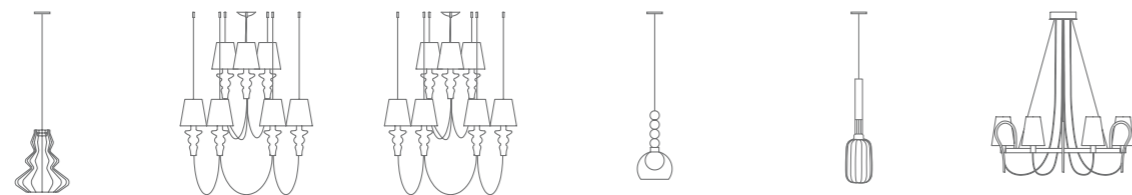

SOFFITTO  
Ceiling lamps

PARETE  
Wall lamps



TAVOLO  
Table lamps



TERRA  
Floor lamps

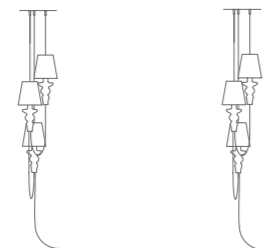

EVISTYLE

SAN MARCO pag. 278	TEARS pag. 270	TESSUTI pag. 302	TROTTOLA pag. 174	VINTAGE pag. 224
-----------------------	-------------------	---------------------	----------------------	---------------------

SOSPENSIONI/  
LAMPADARI  
Pendants/  
Chandeliers

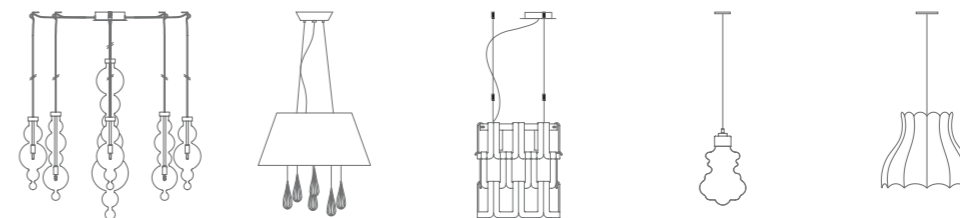

SOFFITTO  
Ceiling lamps

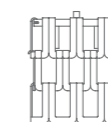

PARETE  
Wall lamps



TAVOLO  
Table lamps



TERRA  
Floor lamps



# SPERIMENTARE LA MATERIA, RICONCEPIRE LO SPAZIO.

---

Experiment the material,  
redesign the space.

Morosini esprime l'essenza più sperimentale del design dell'illuminazione.

Le sue creazioni comunicano la volontà di tracciare nuove frontiere nello stile contemporaneo, rendendo attuali scelte all'avanguardia per mix dei materiali, originalità estetica e compatibilità con l'ambiente. Nello studio della luce e nella pulizia assoluta delle linee risiede la vera anima di Morosini, un'anima eclettica, a volte provocatoria, in un continuo match di rimandi, contrasti e ispirazioni con i gusti e l'arredamento moderno.

Morosini abbina la creatività dirompente di designer emergenti alla qualità produttiva di taglio artigianale tipica del Made in Italy.

Un'idea esclusiva, sorprendente, già conosciuta e riconosciuta in tutto il mondo.

---

Morosini expresses the most experimental essence of lighting design.

Its creations communicate the desire to draw new borders in the contemporary style, making current the choices in the vanguard thanks to the mix of materials, originality and aesthetic compatibility with the environment. The real soul of Morosini is clear in the study of light and in the absolute cleanliness of the lines, an eclectic soul, sometimes provocative, in an ongoing match of references, contrasts and inspirations with the modern tastes and decor.

The typical traditional cut production quality of Made in Italy and the explosive creativity of the emerging designers are combined within Morosini.

An exclusive, unexpected, idea already known and recognized worldwide.

MOROSINI®  
l u c e & d e s i g n



# ARCHETYPE

design\_Marco Taietta

Dall'essenza alla linea,  
dall'idea alla luce.

From the essence to the line,  
from the idea to the light.





Archetype\_SO48/SO60



Archetype\_TE A



Archetype\_PL48



Archetype\_PL48/60

## Cos'è il Dim to Warm?

**Dim to Warm è una tecnologia LED che riduce la temperatura del colore di un apparecchio di illuminazione quando è dimmerata, consentendo variazioni graduali nella luce bianca calda (da 1800K a 3000K).**

La tecnologia è stata progettata per replicare la sensazione familiare e naturale della dimmerazione delle lampade ad incandescenza/alogene. La luce, diffusa o d'accento si integra alla perfezione in ambienti residenziali o pubblici quali hotel e ristoranti.

Come il soffice bagliore di una candela accesa, la luce bianca calda crea un senso di intimità e familiarità. I LED Dim to Warm offrono un ambiente confortevole, riproducendo il calore naturale dell'incandescenza dimmerabile, con prestazioni e flessibilità moderne.



## What is Dim to Warm?

**Dim to Warm is a LED technology that reduces the color temperature of a lighting fixture when dimmed, allowing for smooth variations in warm white light (from 1800K to 3000K).**

The technology was designed to replicate the familiar, natural feeling of dimmed incandescent/halogen. This soft or accent lighting is perfect for use in hotels, restaurants, and homes.

Like the soft glow of a lit candle, warm white light creates a sense of intimacy and familiarity. The Dim to Warm LEDs offer comfortable ambience, replicating the natural warmth of incandescence-style dimming, with modern performance and flexibility.

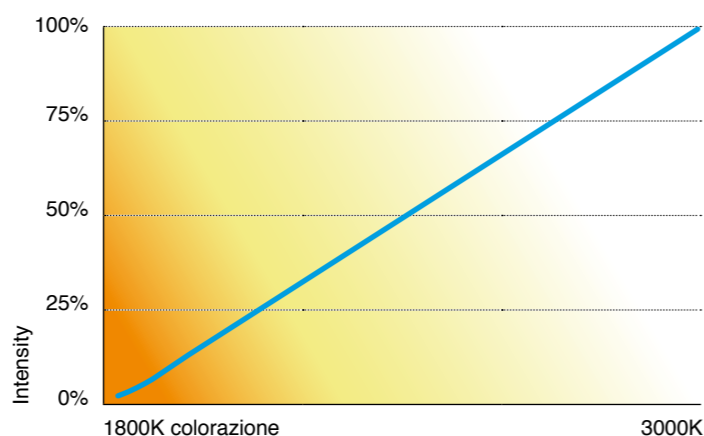

## Come funziona il Dim to Warm?

I LED Dim to Warm della collezione Archetype, non richiedono alcun elemento aggiuntivo per la dimmerazione, ad eccezione di un comune dimmer remoto a taglio di fase. Solo la versione da terra è già fornita con dimmer 1/10V.

## How does Dim to Warm work?

The Dim to Warm LEDs of Archetype collection do not need any additional unit to dimmer, but an usual remote phase cut dimmer. Just the floor lamp is supplied complete with 1/10 V dimmer.



**1800K**  
intensità / intensity 3%



**2400K**  
intensità / intensity 50%



**3000K**  
intensità / intensity 100%

# ARCHETYPE

## \_technical data

In Archetype sono presenti influenze e rimandi alla Golden Age dell'industrial design italiano legato principalmente agli anni '50 e '60. Il paralume in alluminio è costituito da una geometria atemporale che dialoga con l'elemento-luce inferiore. Elastico l'utilizzo: adatto a spazi domestici, progetti di hotel, uffici e non solo. Nella lampada da terra, alla forte connotazione grafica, si aggiunge un gusto contemporaneo con l'utilizzo della fibra di carbonio per il leggero elemento orizzontale in rapporto con la fisicità del supporto verticale. Un progetto fatto di ricordi che prolunga la memoria dell'osservatore, rendendolo un evergreen. Una lampada che c'era e della quale avevamo ancora bisogno...

Archetype embodies influences and references to the Golden Age of Italian industrial design chiefly linked to the 50s and 60s. The aluminum shade consists of a timeless geometry that communicates with the lower lighting element. Versatility of use: suitable for home interiors, hotel projects, offices and much more. The floor standing version features a strong graphic connotation, where a contemporary taste is added via the use of the carbon fiber for the lightweight arm that harmonizes perfectly with the solidity of the vertical support. This design is linked to memories that extend the observer's recollections, thus making it an evergreen. A lighting fixture that had already been designed and of which we still felt the need for...

Archetype présente des influences et des renvois à la Golden Age de l'industrial design italien essentiellement lié aux années 50 et 60.

L'abat-jour en aluminium est constitué par une géométrie hors du temps qui dialogue avec l'élément-lumière inférieur. L'utilisation est polyvalente: il convient aux espaces domestiques, aux projets d'hôtel, aux bureaux, etc.

Le lampadaire, présente une forte connotation graphique, est complété par un goût contemporain avec l'utilisation de fibre de carbone pour l'élément horizontal léger en rapport avec le physique du support vertical.

Un projet fait de souvenirs qui prolonge la mémoire de l'observateur, en en faisant un evergreen. Une lampe qui existait et de laquelle nous avions encore besoin...

Archetype encarna influencias y referencias a la Edad de Oro del diseño industrial italiano principalmente vinculado a los años 50 y 60.

La pantalla de aluminio consiste en una geometría intemporal que se comunica con el elemento de iluminación inferior. Versatilidad de uso: adecuado para interiores de casas, proyectos de hoteles, oficinas y mucho más.

La lámpara de pie presenta una fuerte connotación gráfica en la que se agrega un sabor contemporáneo mediante el uso de fibra de carbono para el brazo horizontal liviano que se armoniza perfectamente con la solidez del soporte vertical.

Este diseño está vinculado al pasado que amplía la memoria del observador, por lo que es un 'evergreen'. Una lámpara que ya había sido diseñada y que la sentimos aun necesaria...

Bei Archetype liegen Einflüsse und Bezüge auf das Golden Age des italienischen Industrial Designs hauptsächlich der 50er und 60er Jahre vor.

Der Aluminiumlampenschirm besteht einer zeitlosen Geometrie, die mit dem unteren Licht-Element dialogiert. Elastisch ist die Anwendung: Für häusliche Umgebungen, Hotelprojekte, Büros und vieles mehr geeignet.

Der graphischen Eigenschaft der Bodenlampe wird ein kontemporärer Stil durch die Anwendung des Kohlenstoffaser für das leichte waagrechte Element in Verbindung mit dem vertikalen Ständer zugefügt.

Ein aus Erinnerungen bestehendes Projekt, welches das Gedächtnis des Betrachters erweitert und es zu einem Evergreen macht. Eine Lampe, die es gab und die wir noch brauchen...

В коллекции Archetype представлены влияния и веяния Золотого Века итальянского промышленного дизайна, связанного, главным образом, с '50 и '60 г.г.

Алюминиевый абажур воплощен в универсальной геометрии на все времена, которая ведет диалог с нижним световым элементом. Многочисленные возможности применения: подходит для домашних интерьеров, гостиничных проектов, офисных пространств и не только.

В напольной лампе к яркой графической характеристике добавлено влияние современного стиля благодаря использованию углеродистого волокна для легкого горизонтального элемента в пропорции со структурой вертикального суппорта.

Проект, созданный воспоминаниями, который уводит память наблюдателя в прошлое, делая его неувядающим. Лампа, которая была и в которой мы вновь нуждались...

**Struttura:** metallo nelle colorazioni: Bianco, Champagne, Nero, Platino.

**Frame:** metal in the colors: white, black, champagne, platinum.

**Struktur:** Metall in den Farben: Weiß, Schwarz, Champagner, Platinum.

**Structure:** métal dans les teintes: blanc, noir, champagne, platine.

**Estructura:** metal en los colores: blanco, negro, champán, platino.

**Структура:** металл окрашенный в: белый, чёрный, Шампань, Платина.

**Diffusore:** metallo nelle colorazioni: Bianco, Champagne, Nero, Platino.

**Diffuser:** metal in the colors: white, black, champagne, platinum.

**Diffusor:** Metall in den Farben: Weiß, Schwarz, Champagner, Platinum.

**Diffuseur:** métal dans les teintes: blanc, noir, champagne, platine.

**Difusor:** metal en los colores: blanco, negro, champán, platino.

**Рассеиватель:** металл окрашенный в: белый, чёрный, Шампань, Платина.

### DIFFUSORE/DIFFUSERS



**BI:** Bianco/White

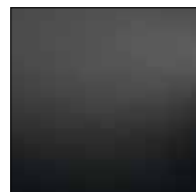

**NE:** Nero/Black



**PL:** Platino/Platinum



**CH:** Champagne

### MONTATURA/FRAME - TE A

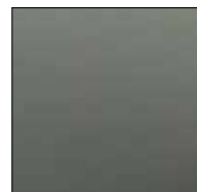

**31:** Platino/Platinum

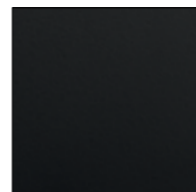

**07:** Nero/Black

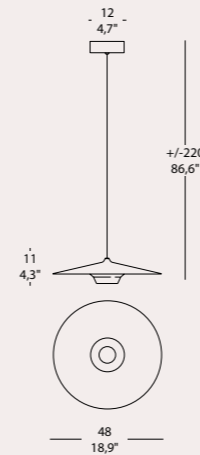

#### ARCHETYPE 50 48

18W Min. 39 Lm - Max 1710 Lm 1800>3000K

Cri > 95 220-240 Vac 50-60hz

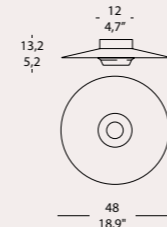

#### ARCHETYPE PL 48

18W Min. 39 Lm - Max 1710 Lm 1800>3000K

Cri > 95 220-240 Vac 50-60hz

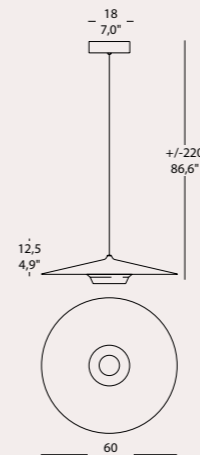

#### ARCHETYPE 50 60

36W Min. 83 Lm - Max 3430 Lm 1800>3000K

Cri > 95 220-240 Vac 50-60hz

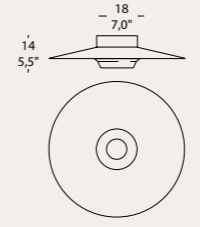

#### ARCHETYPE PL 60

36W Min. 83 Lm - Max 3430 Lm 1800>3000K

Cri > 95 220-240 Vac 50-60hz



### ROSONE/CANOPY - SO 48 - SO 60



**06:** Bianco/White



**BIEMISSIONE/DOUBLE EMISSION**

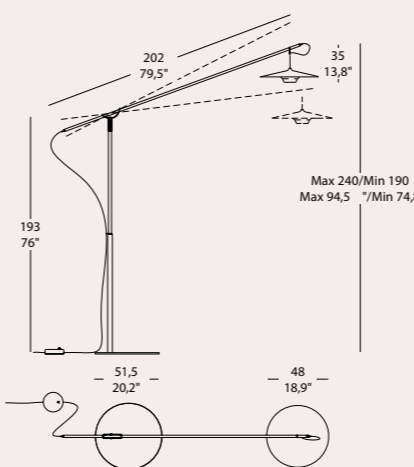

#### ARCHETYPE TE A

18W Min. 39 Lm - Max 1710 Lm 1800>3000K

Cri > 95 220-240 Vac 50-60hz

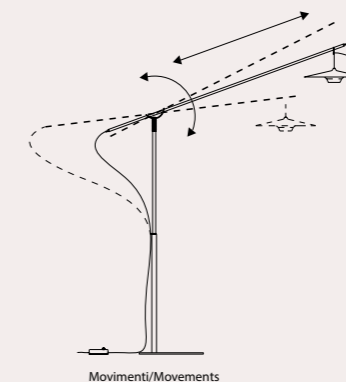

Movimenti/Movements



**Fibra di carbonio**  
Carbon fiber



# VANE

design\_Romani Saccani  
Architetti Associati

Connubio di geometrie  
protagoniste in ogni contesto.

Combination of geometries  
which become protagonists  
in each context.



Vane\_PA1



Vane\_PA1

## VANE

## \_technical data

Come il segnavento da cui eredita il nome, Vane trova la sua naturale collocazione nei punti chiave dello spazio in cui si inserisce.

Dalla fusione di due geometrie nasce una lampada da parete dalle caratteristiche minimali che spicca per equilibrio delle forme e per funzionalità. La sorgente led, disposta "a bandiera" rispetto alla parete, proietta una luce che è possibile ruotare di 325 gradi, offrendo così una varietà di utilizzo modulabile secondo ogni esigenza. In quest'ottica è stata progettata la sagoma dell'impugnatura, studiata per garantire elevati standard di ergonomia e maneggevolezza. Una dinamicità che trova la sua naturale collocazione sia in ambienti domestici che in contesti contract. L'apparecchio è dimmerabile Triac.

Comme la girouette dont elle tient le nom, Vane est naturellement destinée aux points-clés de l'espace dans lequel on l'installe.

La fusion de deux géométries a donné naissance à une applique aux caractéristiques minimales qui se distingue par l'équilibre des formes et par sa fonctionnalité. La source led, disposée "en drapeau" par rapport au mur, projette une lumière qui peut pivoter de 325°, offrant une variété d'utilisation modulable en fonction des besoins. C'est dans cette optique que l'on a façonné une poignée en mesure de garantir de hauts standards d'ergonomie et de maniabilité. Un dynamisme qui s'intègre avec naturel dans les espaces domestiques et des collectivités. L'appareil est dimmable Triac.

Vane, whose name derives from the weather vane, wherever it is placed it finds its natural space.

This wall lamp arises from the merger of two geometries with minimal features and stands out for the formal balance and functionality.

The source led, placed as a "flag" to the wall, beams a light that can be rotated 325 degrees, providing a variety of uses modulated according to all needs. In order to reach this modularity, the grip has a specific shape, designed to ensure high ergonomic and handling standards. A dynamic that finds its natural place both in private and public use. The device is dimmable Triac.

Como la veleta de la que hereda su nombre, Vane encuentra su colocación natural en cualquier sitio se ponga.

De la unión entre dos geometrías, nace una lámpara de pared que sobresale por su carácter minimal, su equilibrio de formas y su funcionalidad.

La fuente led, que se dispone a bandera con respecto a la pared, proyecta una luz que se puede girar de 325°, ofreciendo una variedad de usos que se ajustan a las necesidades. En esta óptica se ha diseñado el perfil de la empuñadura, estudiada para garantizar altos estándares de ergonomía y manejabilidad. Ese dinamismo permite colocarla en entornos tanto domésticos como de contract. El aparato es regulable TRIAC.

Wie die Windfahne, von der sie ihren Namen erhält, findet Vane ihren natürlichen Einsatz in den Schlüsselpunkten des Raums, in den sie eingegliedert wird.

Aus der Verbindung zweier Geometrien entstand eine Wandlampe mit Minimal-Eigenschaften, die dank des Ausgleichs der Formen und der Funktion herausragt. Die Led-Lichtquelle, die gegenüber der Wand „wie eine Fahne“ angeordnet ist, projiziert ein Licht, das um 325 Grad gedreht werden kann, wodurch eine veränderbare Nutzung je nach Anforderung möglich ist. In diesem Rahmen wurde die Form des Griffs entworfen, um eine hohe Ergonomie und eine einfache Bedienung zu gewährleisten. Eine Dynamik, die ihre natürliche Anordnung im Haus wie in Contract-Umgebungen findet. Das Gerät ist über Triac dimmbar.

Vane - в переводе флюгер, где бы ни находился, везде находит для себя подходящее пространство.

Это бра возникает в результате слияния двух геометрических форм, с минимальным количеством особенностей и выделяется своим балансом и функциональностью.

Светодиодный источник света закреплён на стене как флажок, дающий на стену луч света и вращающийся на 325 градусов, обеспечивает множество возможных применений. Для того, чтобы достичь такой вариативности, «голове» светильника придали специальную форму, обеспечивающую высокую эргономичность. Такой функциональности найдётся применение как в частном, так и в общественном интерьере. Светильник может диммироваться с помощью TRIAC.

**Struttura:** metallo nelle colorazioni: bianco opaco, nero opaco, oro opaco, rame opaco.

**Diffusore:** Policarbonato satinato.

**Frame:** metal in the colors: matt white, matt black, matt gold, matt copper.

**Diffuser:** Polycarbonate satin finish.

**Struktur:** Metall in den Farben: Mattweiß, Mattschwarz, Mattgold, Mattkupfer.

**Diffusor:** Satiniertes Polycarbonat.

**Structure:** métal dans les teintes: blanc mat, noir mat, or mate, cuivre mat.

**Diffuseur:** Polycarbonate satiné.

**Estructura:** metal en los colores: blanco mate, negro mate, oro mate, cobre mate.

**Diffusor:** Policarbonato satinado.

**Структура:** металл окрашенный в матовый белый, матовый чёрный, матовый золотой или матовый медный цвет.

**Рассеиватель:** матовый поликарбонат



**BI:** Bianco opaco/  
Matt White



**NE:** Nero opaco/  
Matt Black



**OR:** Oro opaco/  
Matt Gold

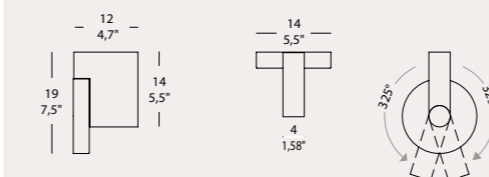

**RA:** Rame opaco/  
Matt copper

**VANE PA1**

10W 950 Lm 2700K Cri>80 Acrich 3 230 Vac 50-60 Hz LED

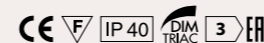



# RAMETTO

design\_Chiaramonte Marin

Ispirata alla natura,  
prende forma attorno a te.

Inspired by nature,  
it takes shape around you.





Rametto\_8 x SO S/R + 7 x BA + RO8



Rametto\_SO S/R + IN1



Rametto\_2 x SO S/R + RO2



Rametto\_3 x SO S/R + RO3



Rametto\_6 x SO S/R + RO6



Rametto\_PA1



Rametto\_PA2



# RAMETTO

## \_technical data

Ispirato alle incantevoli ramificazioni degli alberi e al potere evocativo della natura, Rametto esprime la sua personalità unica nel settore dell'illuminazione grazie a due linee guida precise: modularità e interconnessione. Ad unire i singoli elementi in ceramica, disponibili in quattro colorazioni, intervengono dei magneti, lasciando così ampio spazio alla fantasia e alle possibilità di realizzazione di entità di luce totalmente personalizzabili.

Modularity and interconnection: thanks to these two clear guidelines, Rametto expresses a unique personality in the lighting field, inspired by the beautiful branches of the trees and the evocative power of nature. Magnets are used to combine individual ceramic elements, available in four colors, leaving the imagination free and giving the possibility to create totally customised lighting items.

Modularität und Verbindung: Dank dieser beiden klaren Richtlinien, drückt Rametto eine einzigartige Persönlichkeit im Lichtfeld aus, inspiriert von den schönen Zweigen der Bäume und der eindrucksvollen Kraft der Natur. Magnete, erhältlich in vier Farben, werden verwendet, um einzelne Keramikelemente zu kombinieren. Auf diese Weise lassen sie die Phantasie frei und geben die Möglichkeit, völlig individuelle Lichtelemente zu erstellen.

Rametto, qui s'inspire aux ramifications des arbres et au pouvoir évocateur de la nature, exprime sa personnalité unique dans le secteur de l'éclairage, grâce à deux orientations précises : modularité et interconnexion. Les éléments en céramique, disponibles en trois couleurs, s'unissent par des aimants, en laissant l'espace à la fantaisie et à la possibilité de réaliser des œuvres de lumière entièrement personnalisables.

Rametto, que se inspira a las ramificaciones de los árboles y al poder evocador de la naturaleza, expresa su carácter único en el sector de la iluminación, gracias a dos directrices bien definidas: la modularidad y la interconexión. Los elementos de cerámica, disponibles en cuatro colores, se unen gracias a unos imanes, dejando libre la fantasía y la posibilidad de crear piezas de luces personalizables por completo.

Модульность и взаимосвязь - с помощью этих особенностей Rametto выражает свою индивидуальность, вдохновленный прекрасными ветками деревьев и вызывающий к силам природы. Магниты используются для объединения отдельных керамических элементов, доступных в четырех цветах, позволяя создавать индивидуальные предметы освещения.

**Struttura:** rosone bianco. Ceramica e parti in metallo nelle colorazioni: bianco opaco, nero opaco, oro opaco, rame opaco.

**Frame:** white canopy – ceramic and metal parts in the colors: matt white, matt black, matt gold, matt copper.

**Struktur:** Baldachin: Weiß - Keramik und Metallteile in den Farben: Weißmatt, Schwarz matt, Goldmatt, Kupfermatt.

**Structure:** rosette blanche – céramique et les parties métalliques dans les couleurs: blanc mat, noir mat, or mat, cuivre mat.

**Estructura:** florón blanco – cerámica y partes metálicas en los colores: blanco mate, negro mate, oro mate, cobre mate.

**Структура:** белый розон, керамические и металлические части в цветах: матовый белый, матовый чёрный, матовый золотой, матовый медный.

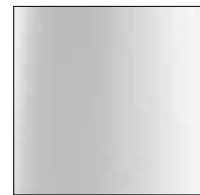

**06:** Bianco opaco/  
Matt White



**07:** Nero opaco/  
Matt Black



**22:** Oro opaco/  
Matt Gold



**29:** Rame opaco/  
Matt copper

## SOSPENSIONI (CAVO STANDARD CM 350 + DECENTRAMENTO)/PENDANT LAMPS (STANDARD CABLE CM 350 + OFF CENTRE POSITION)

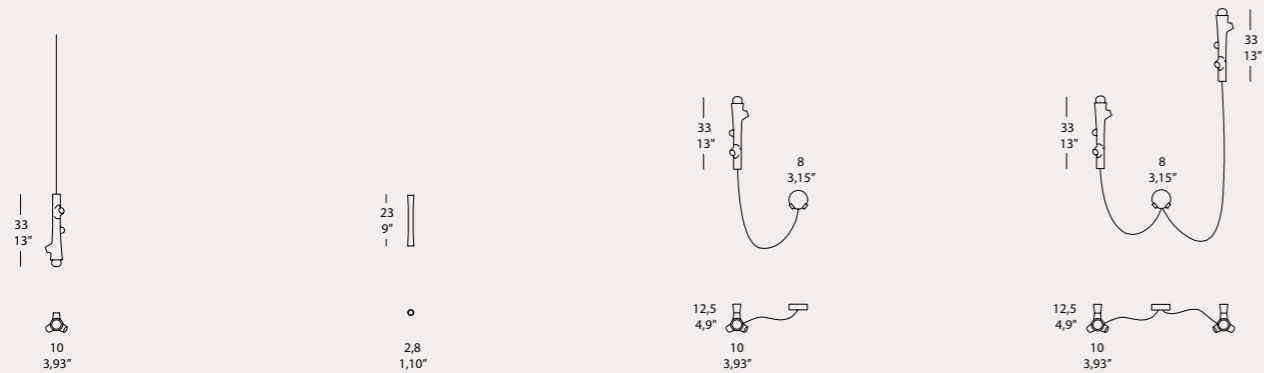

**RAMETTO SO S/R**  
1 x 5,5W E14 LED   
**Consigliata/Recommend**  
**Ledluster Philips**

**RAMETTO BA**

**RAMETTO PA1**  
1 x 5,5W E14 LED   
**Consigliata/Recommend**  
**Ledluster Philips**

**RAMETTO PA2**  
2 x 5,5W E14 LED   
**Consigliata/Recommend**  
**Ledluster Philips**

## ROSONI/CANOPIES

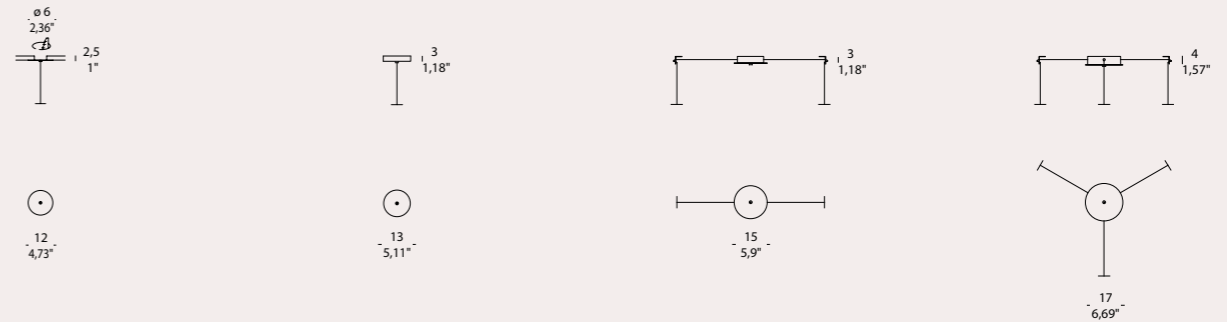

**RAMETTO IN-1**  
ROSONE A 1 LUCE  
1-LIGHT RECESSED CANOPY

**RAMETTO RO-1**  
ROSONE A 1 LUCE  
1-LIGHT CANOPY

**RAMETTO RO-2**  
ROSONE A 2 LUCI  
2-LIGHT CANOPY

**RAMETTO RO-3**  
ROSONE A 3 LUCI  
3-LIGHT CANOPY

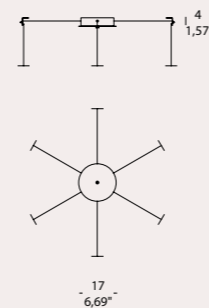

**RAMETTO RO-6**  
ROSONE A 6 LUCI  
6-LIGHT CANOPY

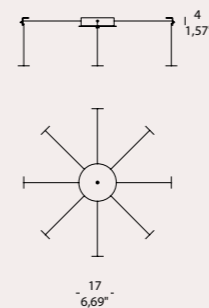

**RAMETTO RO-8**  
ROSONE A 8 LUCI  
8-LIGHT CANOPY

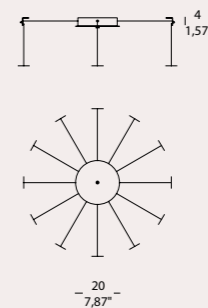

**RAMETTO RO-12**  
ROSONE A 12 LUCI  
12-LIGHT CANOPY

## ESEMPI DI COMPOSIZIONE/EXAMPLES OF COMPOSITION

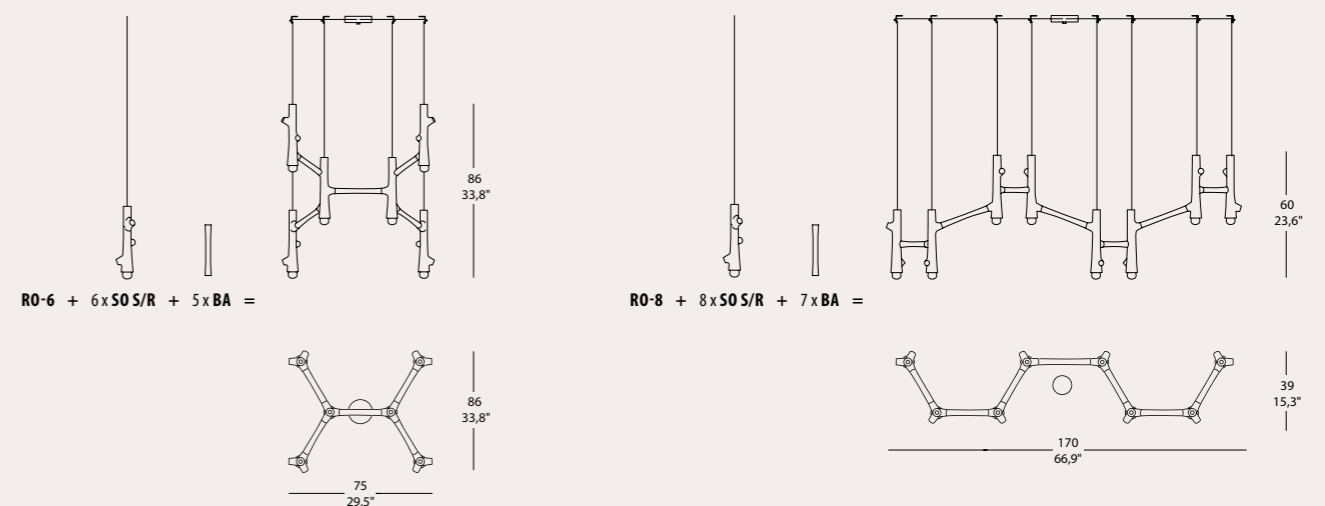



# CUEVA

design\_Filippo Mambretti



prodotto selezionato  
selected product

Pura poesia estetica.

Pure aesthetic poetry.





# CUEVA

Modello Europeo Registrato  
European Registered Design

\_technical data

Cueva è una collezione di lampade a sospensione dal design essenziale quanto ricercato, la prova che si può ottenere pulizia formale anche nella complessità.

L'illuminazione prodotta da sorgenti LED, a contatto con fogli di alluminio minuziosamente sovrapposti, arricchisce di ammalianti chiaroscuri le composizioni geometriche racchiuse all'interno della lampada, e filtrando all'esterno assicura un design sobrio ed essenziale. Da qualunque prospettiva la si guardi, Cueva è pura poesia estetica.

Cueva est une collection de lampes à suspension au design aussi essentiel que raffiné, prouvant que l'on peut également obtenir une netteté formelle dans la complexité.

L'éclairage produit par les sources LED, au contact de feuilles d'aluminium minutieusement superposées, enrichit les compositions géométriques contenues dans la lampe de clairs-obscurs envoûtants, et il assure, en filtrant à l'extérieur, un design sobre et essentiel. Dans toute perspective, Cueva est une pure poésie esthétique.

Cueva is a collection of pendant lamps with an essential but at the same time sophisticated design, proof that you can get clean lines also in complexity. The light produced by LED sources and the carefully overlapping aluminium foils enrich the geometric compositions inside the lamp with a fascinating chiaroscuro, and, filtering from the outside, the light ensures a simple and essential design. From whatever perspective you look at it from, Cueva is pure aesthetic poetry.

Cueva es una colección de lámparas de suspensión de design esencial y rebuscado, la prueba de que se puede obtener esencialidad formal también en la complejidad.

La iluminación producida por fuentes LED, en contacto con hojas de aluminio minuciosamente superpuestas, enriquece de cautivantes claroscuros las composiciones geométricas encerradas en el interior de la lámpara y filtrando en el exterior asegura un design sobrio y esencial.

Desde cualquier perspectiva se vea, Cueva es pura poesía estética.

Cueva ist eine Lampenkollektion mit Abhängung und gewollt einfachem Design. Der Beweis dafür, dass klare Linien auch in der Komplexität entstehen können. Die Ausleuchtung die durch die LED-Lichtquellen erzeugt werden, die wiederum im Kontakt mit den präzise übereinander gelegten Aluminiumstreifen stehen, bereichert mit bezaubernden Hell-Dunkel Kontrasten die geometrischen Kompositionen die im Inneren der Lampe eingeschlossen sind und aussen filtrieren. Ein essenzielles und schlichtes Design.

Aus welcher Perspektive man sie auch betrachtet, Cueva ist reine und ästhetische Poesie.

Cueva – коллекция подвесных светильников простого и в то же время изысканного дизайна, подтверждение того, что возможно добиться определенной чистоты даже в сложности.

Свет, полученный при помощи источников LED, в контакте с алюминиевыми листами, наложенными друг на друга, обогащает завораживающей игрой светотеней геометрические композиции, заключенные внутри светильника, и, фильтруя с внешней стороны, обеспечивает простой и строгий дизайн.

Cueva - это чистая изящная поэзия, с какой бы стороны на нее не посмотреть.

**Struttura:** metallo bianco opaco. **Frame:** matt white metal.  
**Diffusore:** policarbonato opalino. **Diffuser:** opal polycarbonate.

**Struktur:** Metall mattweiß. **Structure:** métal blanc mat.  
**Diffusor:** Polycarbonat opalartig. **Diffuseur:** polycarbonate opalin.  
Weiß.

**Estructura:** metal blanco opaco. **Структура:** белый матовый металл.  
**Дифузор:** policarbonato opalescente. **Рассеиватель:** Поликарбонат опалового цвета.



Cueva\_SO 40

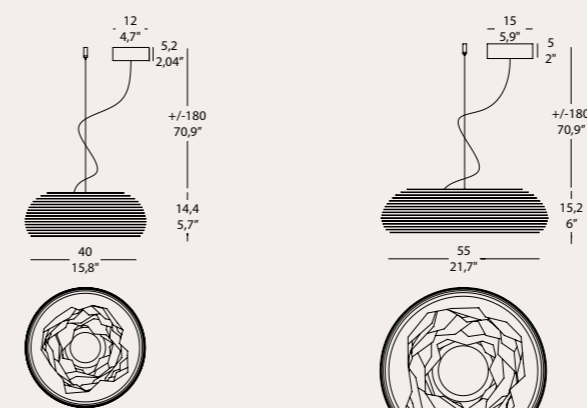

#### CUEVA SO 40

14,4W 1730 Lm 3000K Cri>80 220/240V

14,4W 1665 Lm 2700K Cri>80 220/240V

#### CUEVA SO 40 DIM PD

14,4W 1730 Lm 3000K Cri>80 220/240V

14,4W 1665 Lm 2700K Cri>80 220/240V

Con driver dimmerabile push/with push

dimnable driver 220/240V

#### CUEVA SO 55

27,3W 3690 Lm 3000K Cri>80 220/240V

27,3W 3540 Lm 2700K Cri>80 220/240V

#### CUEVA SO 55 DIM PD

27,3W 3690 Lm 3000K Cri>80 220/240V

27,3W 3540 Lm 2700K Cri>80 220/240V

Con driver dimmerabile push/with push

dimnable driver 220/240V

SU RICHIESTA È POSSIBILE AVERE ANCHE DRIVER DIMMERABILE 1/10V  
1/10V DIMMABLE DRIVER CAN BE SUPPLIED BY REQUEST

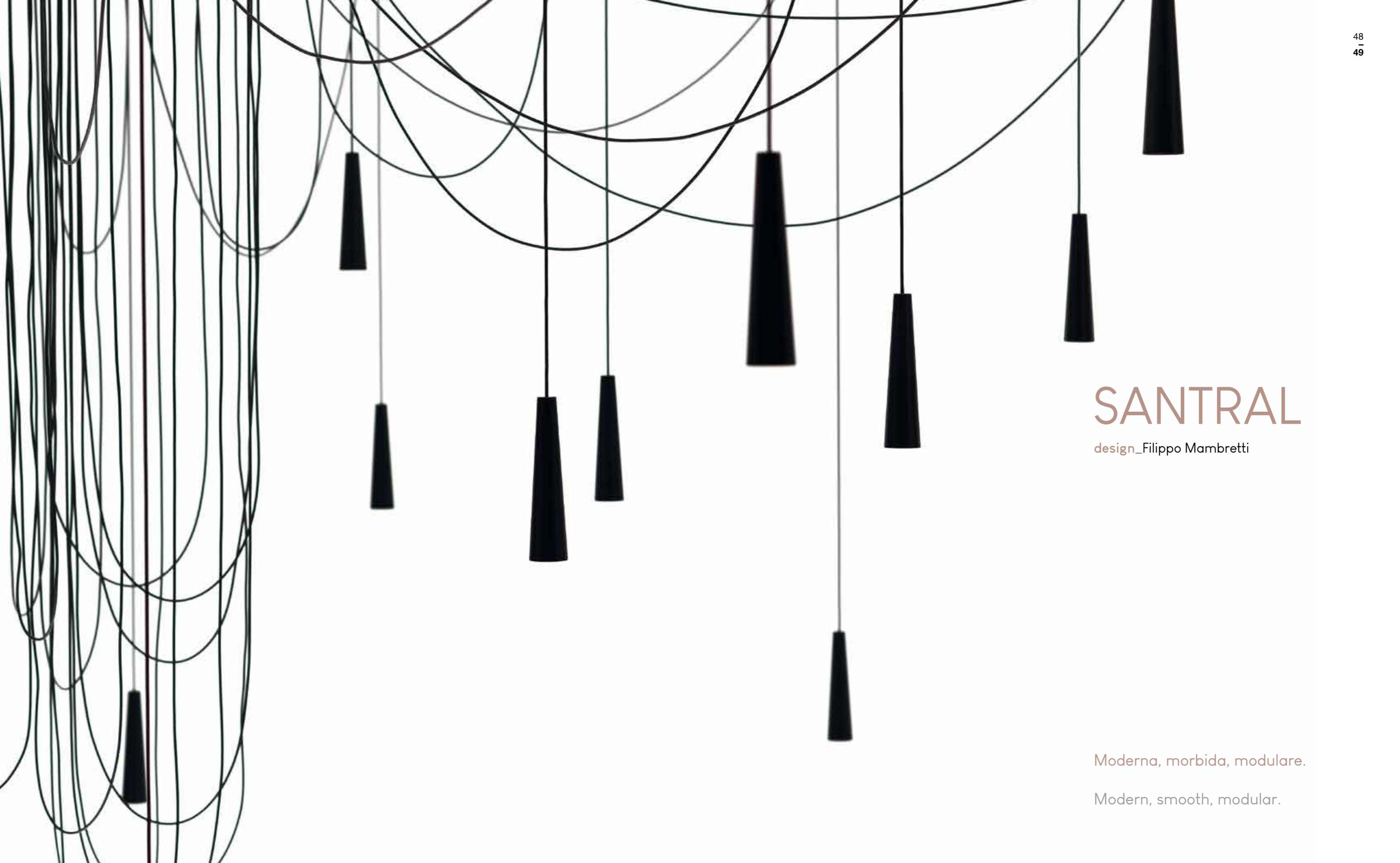

# SANTRAL

design\_Filippo Mambretti

Moderna, morbida, modulare.

Modern, smooth, modular.



Santral\_ esempio di personalizzazione a 24 luci/24 light customized composition example



Santral \_esempio di personalizzazione a 16 luci/ 16 light customized composition example



Santral \_esempio di personalizzazione a 16 luci/16 light customized composition example



Santral\_ esempio di personalizzazione a 24 luci/ 24 light customized composition example



Santral\_ esempio di personalizzazione a 8 luci/ 8 light customized composition example







# MIKADO

design\_Filippo Mambretti



**1° PREMIO  
WINNER**

Intreccio di segni evocativo  
come un ideogramma.

An evocative weave of signs,  
like an ideogram.





Mikado\_LA 6



Mikado\_S3L



Mikado\_LA 12



Mikado\_S5L GLASS





Mikado\_LA 12 GLASS



Mikado\_S2L GLASS



## \_technical data

Rilettrura in chiave destrutturata dell'estetica classica dei lampadari a sospensione. Mikado è un intreccio di linee e piani che producono un fluttuante movimento nello spazio generando figure geometriche semplici o complesse.

Le varie versioni a sospensione, lineari o circolari, permettono diversi gradi di personalizzazione ed elaborazione della struttura: sobria e minimalista o complessa ed eccentrica grazie alla sovrapposizione di piani ad altezze asimmetriche.

Le sorgenti a LED sono racchiuse in particolari metallici di forma conica, disponibili anche con diffusore in vetro soffiato satinato che impreziosisce ulteriormente la collezione.

A deconstructive reinterpretation of the classical aesthetics of pendant chandeliers. Mikado is a mixture of lines and planes that produce a fluctuating movement in space creating simple or complex geometric figures.

The various linear or circular pendant versions allow different degrees of customization and elaboration of the frame: simple and minimalist or complex and eccentric thanks to the overlapping planes at asymmetric heights. The LED sources are enclosed inside of conical metallic elements, available also with satin blown glass diffuser, further enriching the collection.

Eine unstrukturierte Neuinterpretation der klassischen Ästhetik von Hängelampen. Mikado ist ein Geflecht aus Linien und Ebenen das schwankende Bewegungen im Raum produziert, indem es einfache und komplexe Geometrie-Figuren erzeugt. Die verschiedenen Ausführungen der Abhängungen, linear oder kreisförmig, ermöglichen diverse Möglichkeiten der Personalisierung und Ausarbeitung der Struktur: schlicht und minimalistisch, oder komplex und exzentrisch, dank der Überlappung der Ebenen in asymmetrischen Abständen. Die LED-Lichtquellen sind eingeschlossen in metallische Teile mit konischer Form. Erhältlich auch mit Diffusor aus satiniertem und geblasenen Glas, das die Kollektion nochmals erheblich aufwertet.

Новая интерпретация в деструктивном ключе классической эстетики подвесных светильников. Mikado — это переплетение линий и плоскостей, которые вызывает колышущее движение в пространстве, создавая простые и сложные геометрические фигуры. Разнообразные версии подвесного светильника, как с линейным, так и с круговым расположением, позволяют разную степень персонализации и отделки структуры: строгую и минималистичную или, благодаря асимметричному расположению плоскостей по высоте, сложную и эксцентричную. Источники LED заключены в металлические элементы конической формы, которые также могут быть предложены с рассеивателем из дутого сатинового стекла, придающего коллекции дополнительную ценность.

Relecture sous un jour déstructuré de l'esthétique classique des lustres à suspension. Mikado est un enchevêtrement de lignes et de plans qui produisent un mouvement flutuante dans l'espace générant des figures géométriques simples ou complexes. Les différentes versions à suspension, linéaires ou circulaires, permettent différents degrés de personnalisation et d'élaboration de la structure : sobre et minimaliste ou complexe et excentrique grâce à la superposition de plans à des hauteurs asymétriques. Les sources à LED sont contenues dans des éléments métalliques de forme conique, également fournis avec un diffuseur en verre soufflé satiné qui enrichit ultérieurement la collection.

Relectura en clave descompuesta de la estética clásica de las lucernas suspendidas. Mikado es un enredo de líneas y planos que producen un movimiento oscilante en el espacio generando figuras geométricas simples y complejas. Las varias versiones a suspensión, lineales o circulares, permiten varios grados de personalización y elaboración de la estructura: sobria y minimalista o compleja y excéntrica gracias a la sobreposición de planos de alturas asimétricas. Las fuentes de LED están encerradas en detalles metálicos de forma cónica, disponibles incluso con difusor de vidrio soplado satinado que valoriza ulteriormente la colección.

**Struttura:** metallo nero opaco.  
**Diffusore:** vetro satinato.

**Frame:** matt black metal.  
**Diffuser:** satin glass.

**Struktur:** Metall, mattschwarz.  
**Diffusor:** Satiniertes Glas.

**Structure:** métal noir mat.  
**Diffuseur:** verre satiné.

**Estructura:** metal negro opaco.  
**Difusor:** vidrio satinado.

**Структура:** металл, выполняется в черном матовом цвете.  
**Рассеиватель:** Сатинированное стекло.

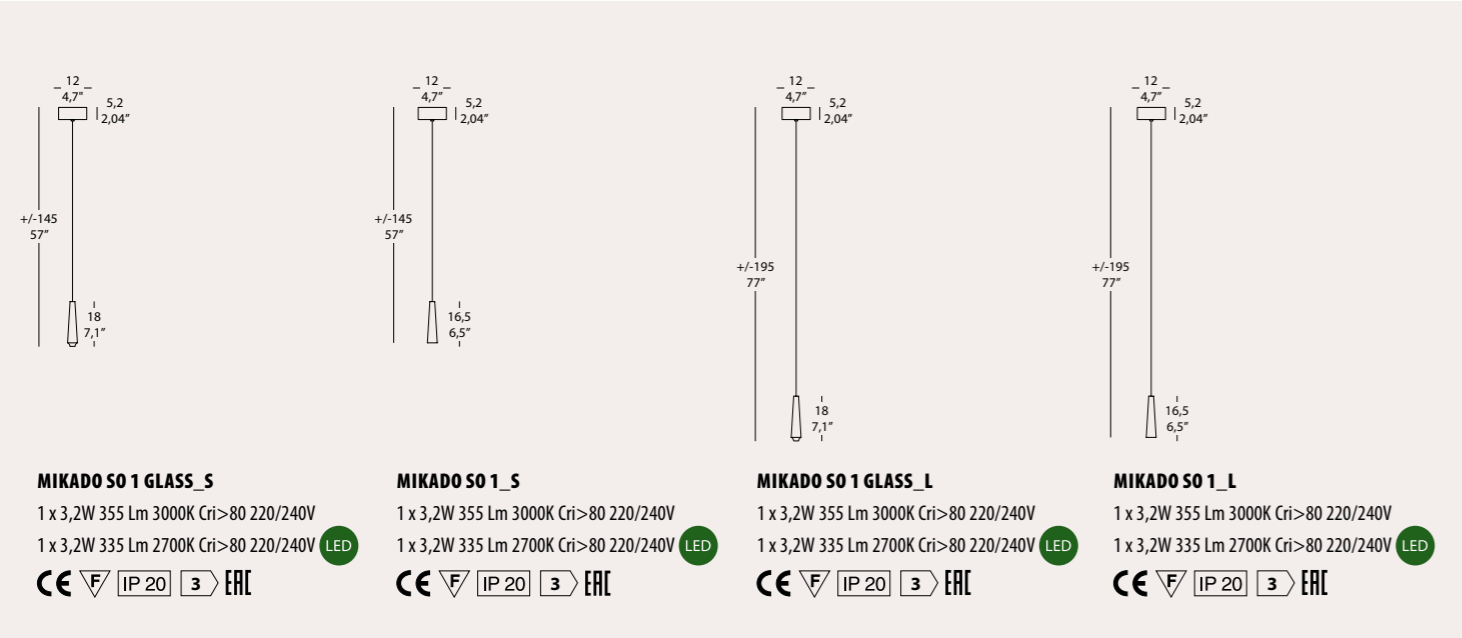
**MIKADO S01 GLASS\_S**

1 x 3,2W 355 Lm 3000K Cri&gt;80 220/240V

1 x 3,2W 335 Lm 2700K Cri&gt;80 220/240V LED

**MIKADO S01 \_S**

1 x 3,2W 355 Lm 3000K Cri&gt;80 220/240V

1 x 3,2W 335 Lm 2700K Cri&gt;80 220/240V LED

**MIKADO S01 GLASS\_L**

1 x 3,2W 355 Lm 3000K Cri&gt;80 220/240V

1 x 3,2W 335 Lm 2700K Cri&gt;80 220/240V LED

**MIKADO S01 \_L**

1 x 3,2W 355 Lm 3000K Cri&gt;80 220/240V

1 x 3,2W 335 Lm 2700K Cri&gt;80 220/240V LED

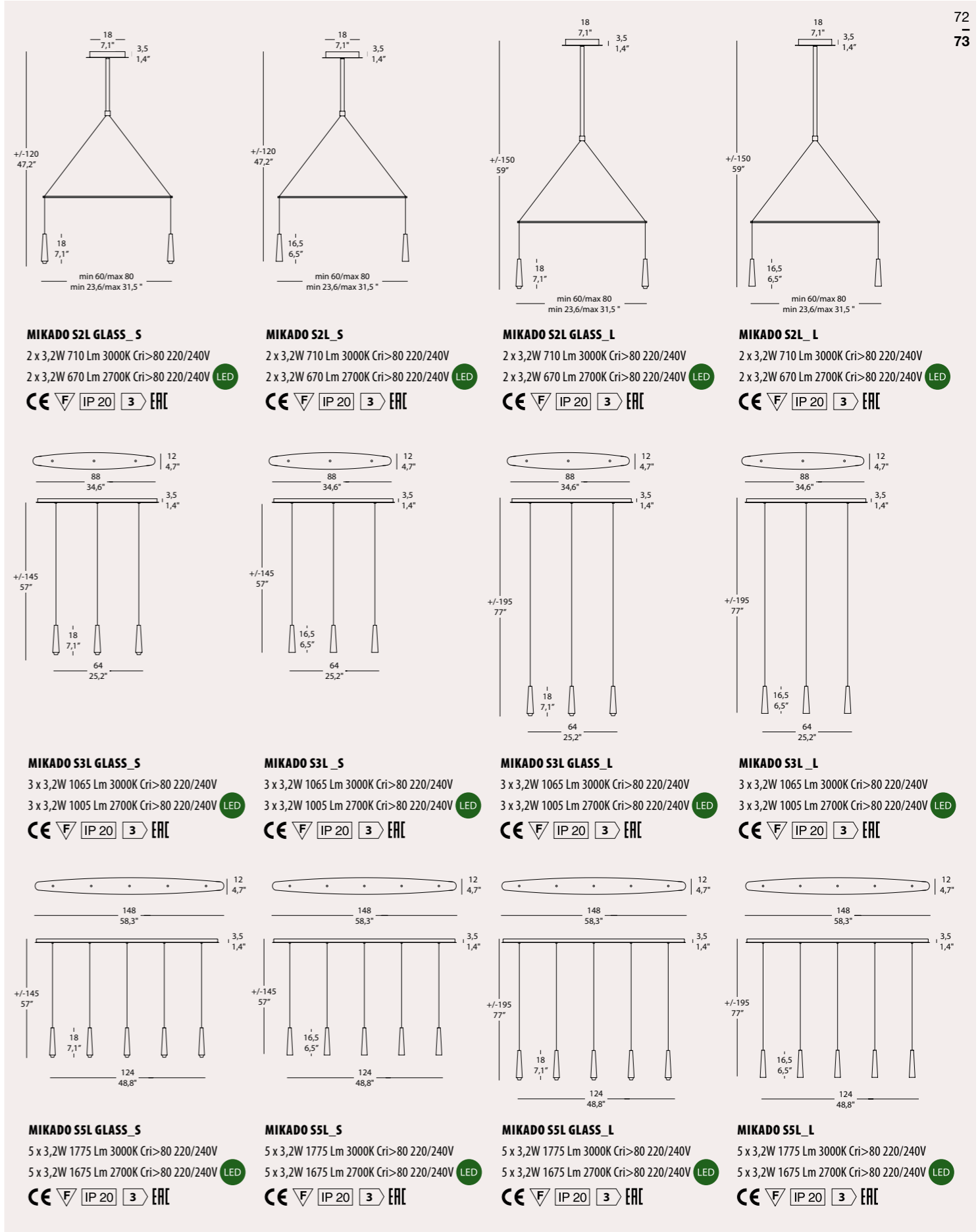
**MIKADO S2L GLASS\_S**

2 x 3,2W 710 Lm 3000K Cri&gt;80 220/240V

2 x 3,2W 670 Lm 2700K Cri&gt;80 220/240V LED

**MIKADO S2L \_S**

2 x 3,2W 710 Lm 3000K Cri&gt;80 220/240V

2 x 3,2W 670 Lm 2700K Cri&gt;80 220/240V LED

**MIKADO S2L GLASS\_L**

2 x 3,2W 710 Lm 3000K Cri&gt;80 220/240V

2 x 3,2W 670 Lm 2700K Cri&gt;80 220/240V LED

**MIKADO S2L \_L**

2 x 3,2W 710 Lm 3000K Cri&gt;80 220/240V

2 x 3,2W 670 Lm 2700K Cri&gt;80 220/240V LED

**MIKADO S3L GLASS\_S**

3 x 3,2W 1065 Lm 3000K Cri&gt;80 220/240V

3 x 3,2W 1005 Lm 2700K Cri&gt;80 220/240V LED

**MIKADO S3L \_S**

3 x 3,2W 1065 Lm 3000K Cri&gt;80 220/240V

3 x 3,2W 1005 Lm 2700K Cri&gt;80 220/240V LED

**MIKADO S3L GLASS\_L**

3 x 3,2W 1065 Lm 3000K Cri&gt;80 220/240V

3 x 3,2W 1005 Lm 2700K Cri&gt;80 220/240V LED

**MIKADO S3L \_L**

3 x 3,2W 1065 Lm 3000K Cri&gt;80 220/240V

3 x 3,2W 1005 Lm 2700K Cri&gt;80 220/240V LED

**MIKADO SSL GLASS\_S**

5 x 3,2W 1775 Lm 3000K Cri&gt;80 220/240V

5 x 3,2W 1675 Lm 2700K Cri&gt;80 220/240V LED

**MIKADO SSL \_S**

5 x 3,2W 1775 Lm 3000K Cri&gt;80 220/240V

5 x 3,2W 1675 Lm 2700K Cri&gt;80 220/240V LED

**MIKADO SSL GLASS\_L**

5 x 3,2W 1775 Lm 3000K Cri&gt;80 220/240V

5 x 3,2W 1675 Lm 2700K Cri&gt;80 220/240V LED

**MIKADO SSL \_L**

5 x 3,2W 1775 Lm 3000K Cri&gt;80 220/240V

5 x 3,2W 1675 Lm 2700K Cri&gt;80 220/240V LED

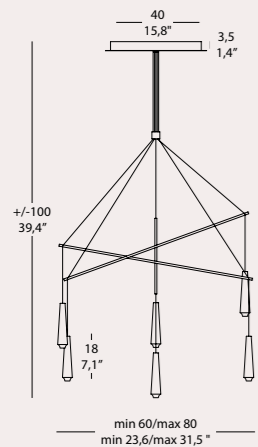

**MIKADO LA 6 GLASS\_S**  
6 x 3,2W 2130 Lm 3000K Cri>80 220/240V  
6 x 3,2W 2010 Lm 2700K Cri>80 220/240V **LED**

**MIKADO LA 6 GLASS\_S DIM PD**  
6 x 3,2W 2130 Lm 3000K Cri>80 220/240V  
6 x 3,2W 2010 Lm 2700K Cri>80 220/240V  
con driver dimmerabile push/with push dimmable driver 220/240V **LED**  
**CE F IP 20 3 EAC**

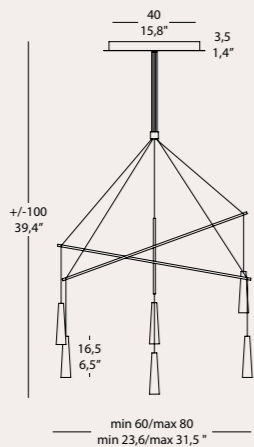

**MIKADO LA 6\_S**  
6 x 3,2W 2130 Lm 3000K Cri>80 220/240V  
6 x 3,2W 2010 Lm 2700K Cri>80 220/240V **LED**

**MIKADO LA 6\_S DIM PD**  
6 x 3,2W 2130 Lm 3000K Cri>80 220/240V  
6 x 3,2W 2010 Lm 2700K Cri>80 220/240V  
con driver dimmerabile push/with push dimmable driver 220/240V **LED**  
**CE F IP 20 3 EAC**

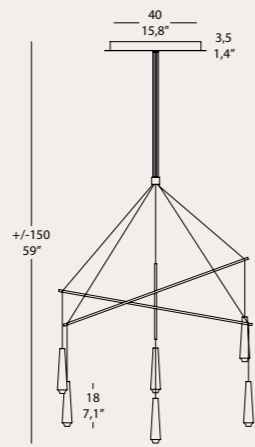

**MIKADO LA 6 GLASS\_L**  
6 x 3,2W 2130 Lm 3000K Cri>80 220/240V  
6 x 3,2W 2010 Lm 2700K Cri>80 220/240V **LED**

**MIKADO LA 6 GLASS\_L DIM PD**  
6 x 3,2W 2130 Lm 3000K Cri>80 220/240V  
6 x 3,2W 2010 Lm 2700K Cri>80 220/240V  
con driver dimmerabile push/with push dimmable driver 220/240V **LED**  
**CE F IP 20 3 EAC**

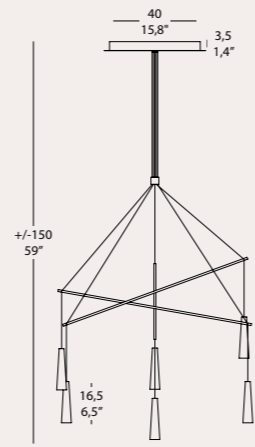

**MIKADO LA 6\_L**  
6 x 3,2W 2130 Lm 3000K Cri>80 220/240V  
6 x 3,2W 2010 Lm 2700K Cri>80 220/240V **LED**

**MIKADO LA 6\_L DIM PD**  
6 x 3,2W 2130 Lm 3000K Cri>80 220/240V  
6 x 3,2W 2010 Lm 2700K Cri>80 220/240V  
con driver dimmerabile push/with push dimmable driver 220/240V **LED**  
**CE F IP 20 3 EAC**

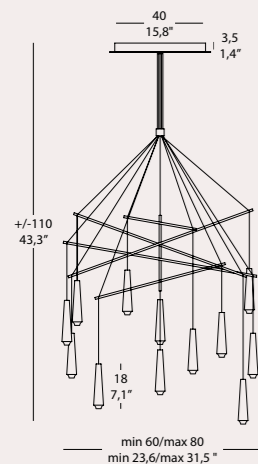

**MIKADO LA 12 GLASS\_S**  
12 x 3,2W 4260 Lm 3000K Cri>80 220/240V  
12 x 3,2W 4020 Lm 2700K Cri>80 220/240V **LED**

**MIKADO LA 12 GLASS\_S DIM PD**  
12 x 3,2W 4260 Lm 3000K Cri>80 220/240V  
12 x 3,2W 4020 Lm 2700K Cri>80 220/240V  
con driver dimmerabile push/with push dimmable driver 220/240V **LED**  
**CE F IP 20 3 EAC**

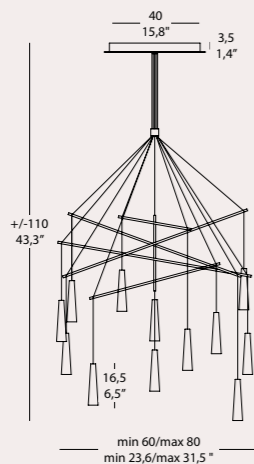

**MIKADO LA 12\_S**  
12 x 3,2W 4260 Lm 3000K Cri>80 220/240V  
12 x 3,2W 4020 Lm 2700K Cri>80 220/240V **LED**

**MIKADO LA 12\_S DIM PD**  
12 x 3,2W 4260 Lm 3000K Cri>80 220/240V  
12 x 3,2W 4020 Lm 2700K Cri>80 220/240V  
con driver dimmerabile push/with push dimmable driver 220/240V **LED**  
**CE F IP 20 3 EAC**

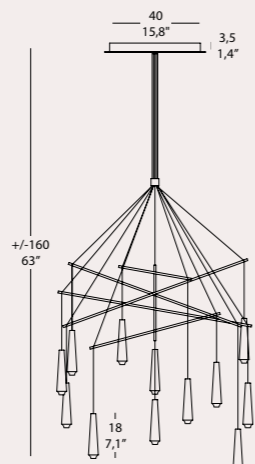

**MIKADO LA 12 GLASS\_L**  
12 x 3,2W 4260 Lm 3000K Cri>80 220/240V  
12 x 3,2W 4020 Lm 2700K Cri>80 220/240V **LED**

**MIKADO LA 12 GLASS\_L DIM PD**  
12 x 3,2W 4260 Lm 3000K Cri>80 220/240V  
12 x 3,2W 4020 Lm 2700K Cri>80 220/240V  
con driver dimmerabile push/with push dimmable driver 220/240V **LED**  
**CE F IP 20 3 EAC**

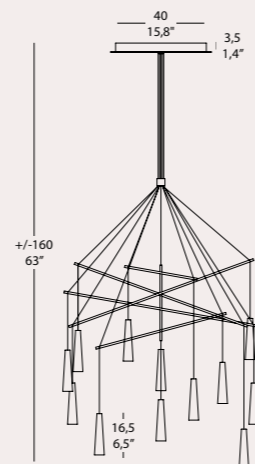

**MIKADO LA 12\_L**  
12 x 3,2W 4260 Lm 3000K Cri>80 220/240V  
12 x 3,2W 4020 Lm 2700K Cri>80 220/240V **LED**

**MIKADO LA 12\_L DIM PD**  
12 x 3,2W 4260 Lm 3000K Cri>80 220/240V  
12 x 3,2W 4020 Lm 2700K Cri>80 220/240V  
con driver dimmerabile push/with push dimmable driver 220/240V **LED**  
**CE F IP 20 3 EAC**

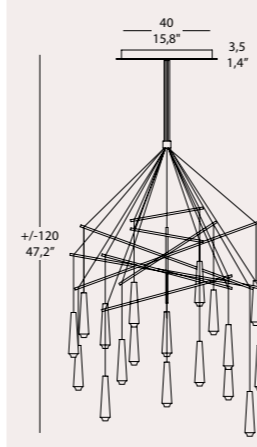

**MIKADO LA 18 GLASS\_S**  
18 x 3,2W 6390 Lm 3000K Cri>80 220/240V  
18 x 3,2W 6030 Lm 2700K Cri>80 220/240V **LED**

**MIKADO LA 18 GLASS\_S DIM PD**  
18 x 3,2W 6390 Lm 3000K Cri>80 220/240V  
18 x 3,2W 6030 Lm 2700K Cri>80 220/240V  
con driver dimmerabile push/with push dimmable driver 220/240V **LED**  
**CE F IP 20 3 EAC**

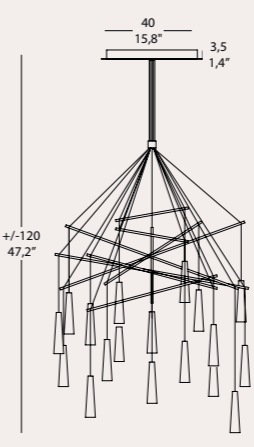

**MIKADO LA 18\_S**  
18 x 3,2W 6390 Lm 3000K Cri>80 220/240V  
18 x 3,2W 6030 Lm 2700K Cri>80 220/240V **LED**

**MIKADO LA 18\_S DIM PD**  
18 x 3,2W 6390 Lm 3000K Cri>80 220/240V  
18 x 3,2W 6030 Lm 2700K Cri>80 220/240V  
con driver dimmerabile push/with push dimmable driver 220/240V **LED**  
**CE F IP 20 3 EAC**

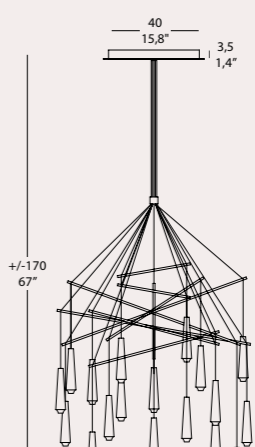

**MIKADO LA 18 GLASS\_L**  
18 x 3,2W 6390 Lm 3000K Cri>80 220/240V  
18 x 3,2W 6030 Lm 2700K Cri>80 220/240V **LED**

**MIKADO LA 18 GLASS\_L DIM PD**  
18 x 3,2W 6390 Lm 3000K Cri>80 220/240V  
18 x 3,2W 6030 Lm 2700K Cri>80 220/240V  
con driver dimmerabile push/with push dimmable driver 220/240V **LED**  
**CE F IP 20 3 EAC**

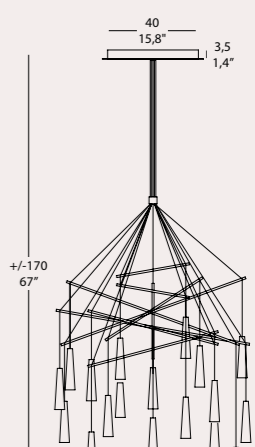

**MIKADO LA 18\_L**  
18 x 3,2W 6390 Lm 3000K Cri>80 220/240V  
18 x 3,2W 6030 Lm 2700K Cri>80 220/240V **LED**

**MIKADO LA 18\_L DIM PD**  
18 x 3,2W 6390 Lm 3000K Cri>80 220/240V  
18 x 3,2W 6030 Lm 2700K Cri>80 220/240V  
con driver dimmerabile push/with push dimmable driver 220/240V **LED**  
**CE F IP 20 3 EAC**

**SU RICHIESTA È POSSIBILE AVERE ANCHE DRIVER DIMMERABILE 1/10V**  
**1/10V DIMMABLE DRIVER CAN BE SUPPLIED BY REQUEST**

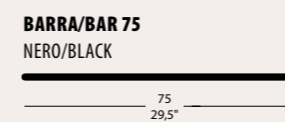
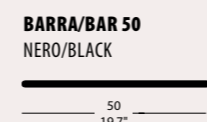

**DIFFUSORE/DIFFUSER**

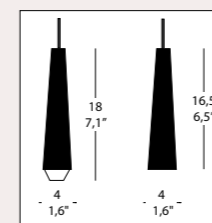



# MIKADO ZERO

design\_Filippo Mambretti

Geometrie di luce.

Lighting geometrics.





Mikado Zero\_ esempio di personalizzazione a 4 luci/4 light customized composition example



Mikado Zero\_ esempio di personalizzazione a 7 luci/7 light customized composition example

# MIKADO ZERO

## \_technical data

illuminazione personalizzabile. Dopo la premiata versione della collezione Mikado, nasce la nuova versione "Mikado Zero". Un nuovo modo di pensare gli spazi e di approcciarsi al progetto, grazie alle infinite configurazioni che possono avere il punto luce sia a soffitto che a parete, creando forme lineari o geometriche di grande effetto scenografico. Disponibile con una serie di rosoni che permettono soluzioni da 2 a 10 elementi in alluminio completi di LED a 2700K e 3000K, con o senza vetro diffusore satinato. L'intera collezione viene fornita in versione dimmerabile.

Customizable lighting. After the award-winning version of the Mikado collection, we have created the new "Mikado Zero" version. A new way of conceiving space and a new design approach thanks to the infinite configurations of ceiling and wall lighting sources that create linear or geometric patterns offering a great scenic effect. Available with a range of ceiling plates that enable solutions featuring 2 to 10 aluminum elements with 2700K and 3000K LEDs, with or without frosted glass. The entire collection is supplied in a dimmable version.

Individuell gestaltbare Beleuchtung. Infolge der ausgezeichneten Version der Kollektion Mikado entsteht die neue Version "Mikado Light". Eine neue Weise, die Räume zu entwerfen und sich dem Projekt zu nähern, dank der unendlichen Konfigurationen, die einen Lichtpunkt an der Decke wie an der Wand haben können und so lineare oder geometrische Formen mit einem effektvollen szenographischen Effekt bilden. Mit verschiedenen Rosetten, die Lösungen mit 2 bis 10 Elementen aus Aluminium ermöglichen, einschließlich LED mit 2700K und 3000K, mit oder ohne satiniertem Glaslichtschirm. Die ganze Kollektion wird in der dimmerbaren Ausführung geliefert.

Éclairage personnalisable. Après la version mainte fois primée de la collection Mikado, voici la nouvelle version "Mikado Zero". Une nouvelle manière de concevoir les espaces et d'aborder le projet, grâce aux infinies configurations possibles de l'éclairage au plafond ou mural, en créant des formes linéaires ou géométriques d'un grand effet scénographique. Elle est dotée d'une série de rosettes pour des solutions de 2 à 10 éléments en aluminium, avec des LED de 2700K et 3000K, avec ou sans diffuseur en verre satiné. L'ensemble de la collection est fourni dans la version dimmable.

Iluminación personalizable. Después de la versión premiada de la colección Mikado, hemos creado la nueva versión "Mikado Zero". Una nueva forma de concebir el espacio y un nuevo enfoque de diseño gracias a las configuraciones infinitas de fuentes de luz de techo y pared que crean patrones lineales o geométricos que ofrecen un gran efecto escénico. Disponible con una serie de florones que permiten una solución de 2 a 10 elementos en todos los componentes de LED a 2700K y 3000K, con o sin vidrio esmerilado. Todas las lámparas de la colección tienen el dimmer incorporado.

Настраиваемое освещение. После высоко оцененной версии коллекции Mikado, создана новая версия "Mikado Zero". Новый способ осмысливания пространства и ознакомления с проектом благодаря многочисленным возможностям конфигураций, которые позволяют иметь источники освещения как на потолке, так и на стене, создавая линейные или геометрические формы впечатляющего сценарического эффекта. Предоставляется с комплектацией серий круглых розеток, которые позволяют осуществить решения с элементами из алюминия от 2 до 10 штук, укомплектованные ЛЕД 2700К и 3000К, с или без матированного рассеивающего стекла. Полная коллекция предоставляется в версии регулируемой яркости.

**Struttura:** metallo nero opaco o oro.

**Frame:** matt black metal or gold.

**Struktur:** Metall, mattschwarz oder Gold.

**Structure:** métal noir mat ou or. **Diffuseur:** verre satiné.

**Estructura:** metal negro opaco o oro.

**Структура:** металл, выполняется в цвете: черный матовый или золото. **Рассеиватель:** Сатинированное стекло.

**Diffusore:** vetro satinato.

**Diffuser:** satin glass.

**Diffusor:** Satiniertes Glas.



**07:** Nero opaco/  
Matt Black



**22:** Oro opaco/  
Matt Gold

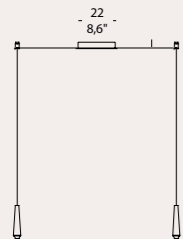

### MIKADO ZERO SO 2 GLASS DIM PD

2 x 3,2W 710 Lm 3000K Cri>80 220/240V  
2 x 3,2W 670 Lm 2700K Cri>80 220/240V  
con driver dimmerabile push  
with push dimmable driver 220/240V

CE IP 20 EAC

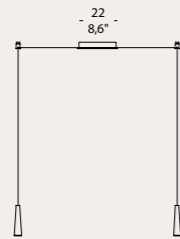

### MIKADO ZERO SO 2 DIM PD

2 x 3,2W 710 Lm 3000K Cri>80 220/240V  
2 x 3,2W 670 Lm 2700K Cri>80 220/240V  
con driver dimmerabile push  
with push dimmable driver 220/240V

CE IP 20 EAC

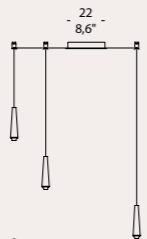

### MIKADO ZERO SO 3 GLASS DIM PD

3 x 3,2W 1065 Lm 3000K Cri>80 220/240V  
3 x 3,2W 1005 Lm 2700K Cri>80 220/240V  
con driver dimmerabile push  
with push dimmable driver 220/240V

CE IP 20 EAC

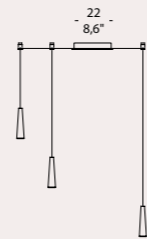

### MIKADO ZERO SO 3 DIM PD

3 x 3,2W 1065 Lm 3000K Cri>80 220/240V  
3 x 3,2W 1005 Lm 2700K Cri>80 220/240V  
con driver dimmerabile push  
with push dimmable driver 220/240V

CE IP 20 EAC

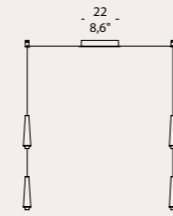

### MIKADO ZERO SO 4 GLASS DIM PD

4 x 3,2W 1420 Lm 3000K Cri>80 220/240V  
4 x 3,2W 1340 Lm 2700K Cri>80 220/240V  
con driver dimmerabile push  
with push dimmable driver 220/240V

CE IP 20 EAC

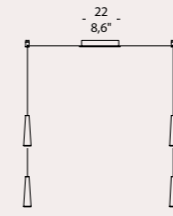

### MIKADO ZERO SO 4 DIM PD

4 x 3,2W 1420 Lm 3000K Cri>80 220/240V  
4 x 3,2W 1340 Lm 2700K Cri>80 220/240V  
con driver dimmerabile push  
with push dimmable driver 220/240V

CE IP 20 EAC

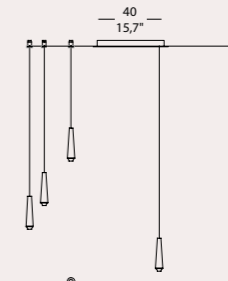

### MIKADO ZERO SO 5 GLASS DIM PD

5 x 3,2W 1775 Lm 3000K Cri>80 220/240V  
5 x 3,2W 1675 Lm 2700K Cri>80 220/240V  
con driver dimmerabile push  
with push dimmable driver 220/240V

CE IP 20 EAC

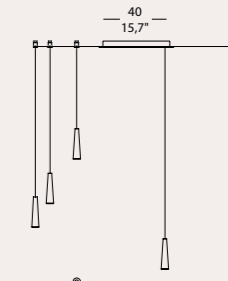

### MIKADO ZERO SO 5 DIM PD

5 x 3,2W 1775 Lm 3000K Cri>80 220/240V  
5 x 3,2W 1675 Lm 2700K Cri>80 220/240V  
con driver dimmerabile push  
with push dimmable driver 220/240V

CE IP 20 EAC

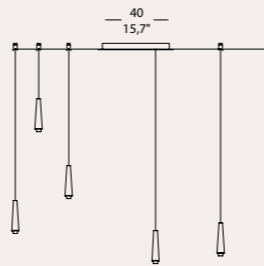

### MIKADO ZERO SO 6 GLASS DIM PD

6 x 3,2W 2130 Lm 3000K Cri>80 220/240V  
6 x 3,2W 2010 Lm 2700K Cri>80 220/240V  
con driver dimmerabile push  
with push dimmable driver 220/240V

CE IP 20 EAC

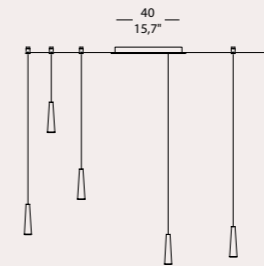

### MIKADO ZERO SO 6 DIM PD

6 x 3,2W 2130 Lm 3000K Cri>80 220/240V  
6 x 3,2W 2010 Lm 2700K Cri>80 220/240V  
con driver dimmerabile push  
with push dimmable driver 220/240V

CE IP 20 EAC

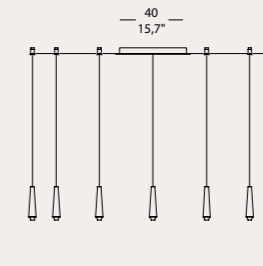

### MIKADO ZERO SO 7 GLASS DIM PD

7 x 3,2W 2485 Lm 3000K Cri>80 220/240V  
7 x 3,2W 2345 Lm 2700K Cri>80 220/240V  
con driver dimmerabile push  
with push dimmable driver 220/240V

CE IP 20 EAC

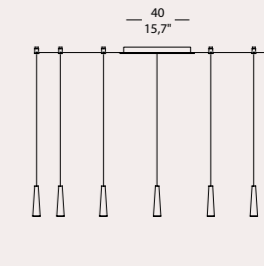

### MIKADO ZERO SO 7 DIM PD

7 x 3,2W 2485 Lm 3000K Cri>80 220/240V  
7 x 3,2W 2345 Lm 2700K Cri>80 220/240V  
con driver dimmerabile push  
with push dimmable driver 220/240V

CE IP 20 EAC

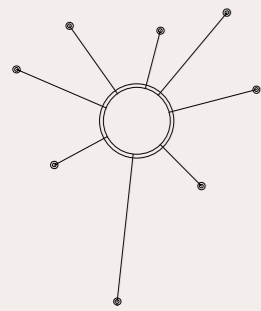
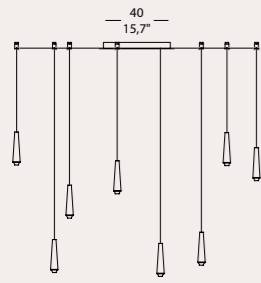

**MIKADO ZERO S0 8 GLASS DIM PD**  
 8 x 3,2W 2840 Lm 3000K Cri>80 220/240V  
 8 x 3,2W 2680 Lm 2700K Cri>80 220/240V  
 con driver dimmerabile push  
 with push dimmable driver 220/240V **LED**  
**CE** **F** **IP 20** **3** **ERC**

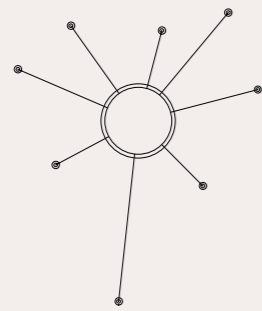
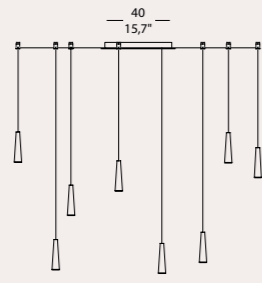

**MIKADO ZERO S0 8 DIM PD**  
 8 x 3,2W 2840 Lm 3000K Cri>80 220/240V  
 8 x 3,2W 2680 Lm 2700K Cri>80 220/240V  
 con driver dimmerabile push  
 with push dimmable driver 220/240V **LED**  
**CE** **F** **IP 20** **3** **ERC**

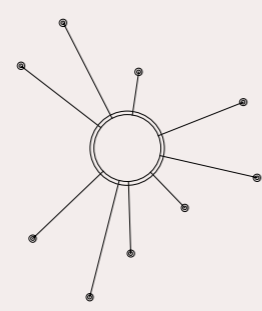
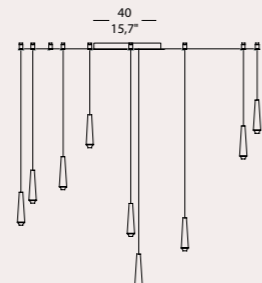

**MIKADO ZERO S0 9 GLASS DIM PD**  
 9 x 3,2W 3195 Lm 3000K Cri>80 220/240V  
 9 x 3,2W 3015 Lm 2700K Cri>80 220/240V  
 con driver dimmerabile push  
 with push dimmable driver 220/240V **LED**  
**CE** **F** **IP 20** **3** **ERC**

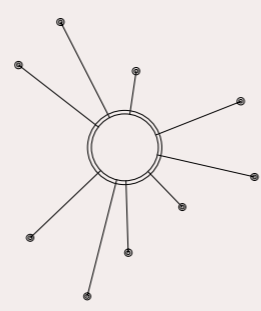
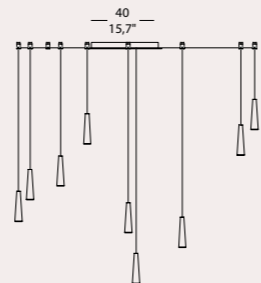

**MIKADO ZERO S0 9 DIM PD**  
 9 x 3,2W 3195 Lm 3000K Cri>80 220/240V  
 9 x 3,2W 3015 Lm 2700K Cri>80 220/240V  
 con driver dimmerabile push  
 with push dimmable driver 220/240V **LED**  
**CE** **F** **IP 20** **3** **ERC**

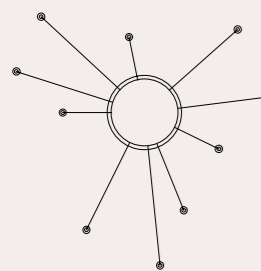
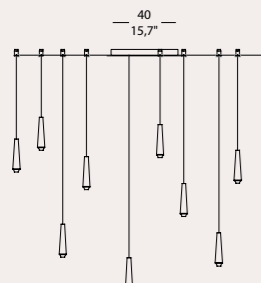

**MIKADO ZERO S0 10 GLASS DIM PD**  
 10 x 3,2W 3550 Lm 3000K Cri>80 220/240V  
 10 x 3,2W 3350 Lm 2700K Cri>80 220/240V  
 con driver dimmerabile push  
 with push dimmable driver 220/240V **LED**  
**CE** **F** **IP 20** **3** **ERC**

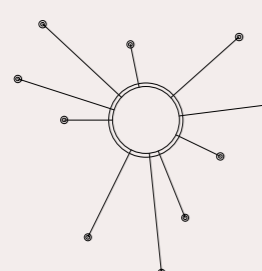
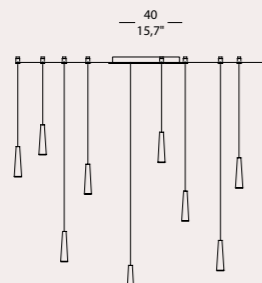

**MIKADO ZERO S0 10 DIM PD**  
 10 x 3,2W 3550 Lm 3000K Cri>80 220/240V  
 10 x 3,2W 3350 Lm 2700K Cri>80 220/240V  
 con driver dimmerabile push  
 with push dimmable driver 220/240V **LED**  
**CE** **F** **IP 20** **3** **ERC**

**DIFFUSORE/DIFFUSER**

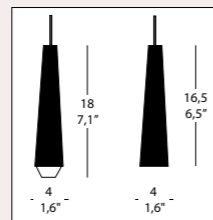

**SU RICHIESTA È POSSIBILE AVERE ANCHE DRIVER DIMMERABILE 1/10V.  
 1/10V DIMMABLE DRIVER CAN BE SUPPLIED BY REQUEST.**

**ESEMPI DI PERSONALIZZAZIONE/CUSTOMIZED COMPOSITION EXAMPLE**

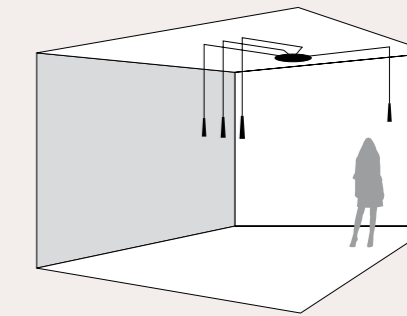
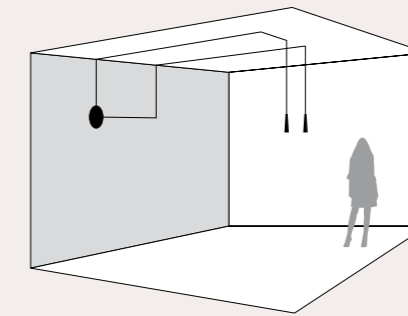
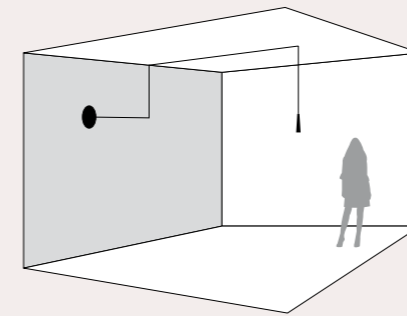

**COMPOSIZIONI STANDARD/STANDARD COMPOSITIONS**

	Cavo corto Short cable	Cavo lungo Long cable	Decentramento Off centre position
<b>S0 2</b>	N.2	N.0	N.2
<b>S0 3</b>	N.2	N.1	N.3
<b>S0 4</b>	N.2	N.2	N.4
<b>S0 5</b>	N.3	N.2	N.5
<b>S0 6</b>	N.4	N.2	N.6
<b>S0 7</b>	N.4	N.3	N.7
<b>S0 8</b>	N.5	N.3	N.8
<b>S0 9</b>	N.6	N.3	N.9
<b>S0 10</b>	N.6	N.4	N.10



# PANK

design\_Tiziano Maffione

Un taglio decisamente particolare.

Definitely a peculiar cut.



Pank\_SO 23



Pank\_SO 30/50



Pank\_SO 30



Pank\_SO 18





Pank\_TE

Pank\_PL 18 / 23 / 30 / 50



Pank\_TA





Pank\_PL 30



Pank\_PL 90

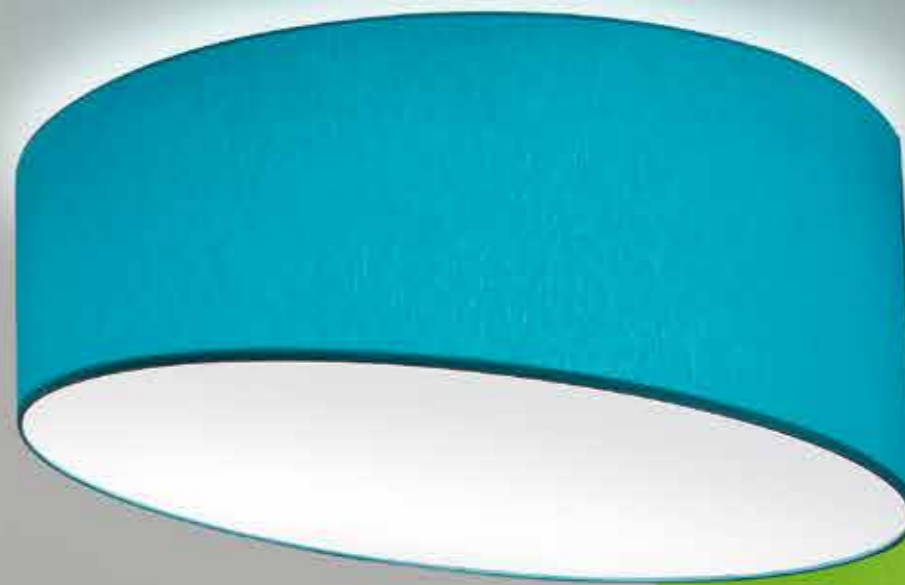



Pank\_PL 120



**AV:** Avorio/Ivory



**AZ:** Azzurro/Sky-blue



**BI:** Bianco/White



**GR:** Grigio/Grey



**RE:** Rosso/Red



**TO:** Tortora/Dove-Grey



**VE:** Verde/Green



**NE:** Nero/Black

I COLORI ORIGINALI DEI PARALUMI, POSSONO DIFFERIRE DALLA RIPRODUZIONE SU CARTA, SIA DA ACCESI CHE DA SPENTI.

THE EFFECTIVE COLOURS OF THE LAMPSHADES MAY DIFFER SLIGHTLY FROM THE COLOURS REPRODUCED ON PAPER, WITH THE LIGHT EITHER ON OR OFF.

ES IST MÖGLICH, DASS SICH DIE ORIGINALFARBEN DER LAMPENSCHIRME VON DER ABBILDUNG AUF PAPIER UNTERSCHIEDEN, SOWOHL IM LEUCHTZUSTAND ALS AUCH IM ERLOSCHENEN ZUSTAND.

LES COULEURS ORIGINALES DES ABAT-JOUR (LAMPE ETEINTE OU ALLUMÉE) PEUVENT DIFFÉRER DE LA REPRODUCTION SUR PAPIER.

LOS COLORES ORIGINALES DE LAS PANTALLAS PUEDEN DIFERIR DE LA REPRODUCCIÓN EN PAPEL, TANTO AL ESTAR ENCENDIDAS COMO APAGADAS.

ОРИГИНАЛЬНЫЕ ЦВЕТА АБАЖУРОВ МОГУТ ОТЛИЧАТЬСЯ ОТ ВОСПРОИЗВЕДЕННЫХ НА БУМАГЕ, КАК ВО ВКЛЮЧЕННОМ, ТАК И В ОТКЛЮЧЕННОМ СОСТОЯНИИ.





# FOG

design\_Andrea Lazzari  
Massimo Tonetto

Veste di velo,  
anima di vetro.

An ethereal shade  
and a softly glowing light.





Fog\_SO 35



Fog\_SO 50







Fog\_PA 30



Fog\_TE



Fog\_PL 50



Fog\_CO

# FOG

## \_technical data

Con Fog, Morosini ha rivoluzionato il concetto di lampade a paralume. L'inserimento all'interno dei diffusori in stoffa Pongé di un elemento in vetro soffiato che traspare come immerso in una nebbia di luce è l'elemento caratterizzante che ha decretato il successo di questa collezione. Una scelta che non offusca, anzi risalta la raffinatezza estetica della collezione Fog e la qualità dei materiali selezionati, sprigionando intorno alla lampada un'atmosfera delicata ed elegante, che arreda con semplicità e gusto soprattutto i grandi ambienti. Le lampade Fog sono infatti disponibili in molteplici versioni e dimensioni, anche su misura. Il tessuto utilizzato per i paralumi ha passato la prova del filo incandescente a 850°C, che lo rende adatto anche a installazioni in ambienti pubblici.

Avec Fog, Morosini a révolutionné le concept de lampe à abat-jour. L'insertion à l'intérieur des diffuseurs en tissu d'un élément en verre soufflé qui transparaît comme s'il était immergé dans un brouillard de lumière est l'élément caractérisant qui a décréte le succès de cette collection. Un choix qui n'offusque pas, ou plutôt qui met en valeur le raffinement esthétique de la collection Fog et la qualité des matériaux sélectionnés, dégagant autour de la lampe une atmosphère délicate et élégante, qui décore avec simplicité et goût surtout les grands espaces. Les lampes Fog sont en effet fournies dans de nombreuses versions et dimensions, également sur mesure. Le tissu utilisé pour les abat-jour a subi avec succès l'essai du fil incandescent à 850° qui permet de l'utiliser dans les lieux publics.

Creating Fog, Morosini has revolutionized the concept of lamps with lampshades. The element in blown glass inside the fabric pongé shades that appears as immersed in a light fog, is the key element that has guaranteed the success of this collection. A choice that does not obscure, indeed shows the aesthetic refinement of the collection Fog and the quality of the selected materials, creating around the lamp a delicate and elegant atmosphere, which furnishes with simplicity and taste especially large spaces. Fog lamps are available in fact in several models and sizes, also customized. The fabric used for the lampshades passed the glow wire test at 850°C, which makes it suitable for installation in public spaces.

Con Fog, Morosini ha revolucionado el concepto de lámparas de pantallas. La inclusión en el interior de los difusores de tela Pongé de un elemento de vidrio soplado que trasparece como inmerso en una niebla de luz es el elemento característico que ha hecho el éxito de esta colección. Una elección que no ofusca sino al contrario, pone de manifiesto el refinamiento estético de la colección Fog y la calidad de los materiales seleccionados, liberando alrededor de la lámpara una atmósfera delicada y elegante, que decora con sencillez y gusto sobre todo grandes ambientes. Las lámparas Fog están en efecto disponibles en múltiples versiones y dimensiones incluso a la medida. El tejido utilizado para las pantallas ha pasado la prueba del hilo incandescente a 850° que lo hace apto incluso para instalaciones en ambientes públicos.

Mit Fog hat Morosini das Konzept der Lampen mit Lampenschirm revolutioniert. Das Einführen in die Pongé-Stoffdiffusoren eines geblasenen Glaselements, das wie in einen Lichtnebel getaucht durchscheint, ist das charakterisierende Element, das den Erfolg dieser Kollektion ausgezeichnet hat. Eine Entscheidung, die die ästhetische Eleganz der Kollektion und die Qualität der gewählten Materialien nicht verschleiert, sondern hervorhebt und um die Lampe eine zarte und elegante Atmosphäre bildet, die mit Einfachheit und Geschmack vor allem große Umgebungen einrichtet. Die Lampen Fog sind vielmehr in zahlreichen Versionen und Abmessungen erhältlich, auch nach Kundenwünschen angepasst. Die Stoffe für die Lampenschirme haben die Glühdrahtprüfung bei 850°C bestanden, somit kann die Lampe auch für öffentliche Umgebungen verwendet werden.

Morosini с коллекцией Fog коренным образом изменяет само понятие лампы и абажура. Размещение внутри рассеивателя из ткани Pongé элемента из дутого стекла, просвечивающегося как-будто погруженный в светящийся туман – ключевое решение, принесшее успех этой коллекции. Выбор, который не только не затмевает, более того, подчеркивает эстетическую утонченность коллекции Fog и качество выбранных материалов, распространяя вокруг лампы элегантную и нежную атмосферу, способную с простотой и вкусом украсить прежде всего большие пространства. Светильники Fog доступны в различных версиях и размерах, также имеется возможность создавать модели по индивидуальным заказам. Ткань, используемая для абажура, прошла испытание раскаленной проволокой при температуре 850°C. Таким образом ее можно использовать для общественных помещений.

**Struttura:** metallo nichel satinato, disponibile nelle varianti bianco opaco e nero opaco per la sola versione da terra ad arco.

**Frame:** satin finish nickel metal, available also in matt white and matt black only for the arc floor version.

**Diffusore:** milkwhite frosted blown glass and Pongé fabric lampshades available in these colors: white, black and moka. Glow wire test at 850°.

**Struktur:** Metall nickelsatiniert, mattweiß und mattschwarz nur für die Boden-Bogenlampe erhältlich.

**Diffusor:** Satiniertes, milchweißes geblasenes Glas und Lampenschirme aus Pongé-Stoff in den Farben: Weiß, Schwarz und Mokka. Glühdrahtprüfung bei 850°C.

**Structure:** métal nickel satiné, fourni dans les variantes blanc mat et noir mat uniquement pour le lampadaire en arc.

**Diffuseur:** verre soufflé blanc lait satiné et abat-jour en tissu Pongé dans les coloris blanc, noir et moka. Essai au fil incandescent 850°.

**Estructura:** metal níquel satinado, disponible en las variables blanco opaco y negro opaco solo para versión de pie a arco.

**Difusor:** vidrio soplado blanco leche satinado y pantallas de tela Pongé en los colores: blanco, negro y moka. Prueba del hilo incandescente 850°.

**Структура:** сатинированный никель. Для торшера, в виде арки, может быть выполнена также в матовом белом или матовом черном цветах. **Рассеиватель:** дутое матовое стекло молочного белого цвета; абажуры из ткани Pongé белого, черного и темно-коричневого цвета. Испытание раскаленной проволокой при 850°C.



BI: Bianco/White MK: Moka/Moka NO: Nero/Black

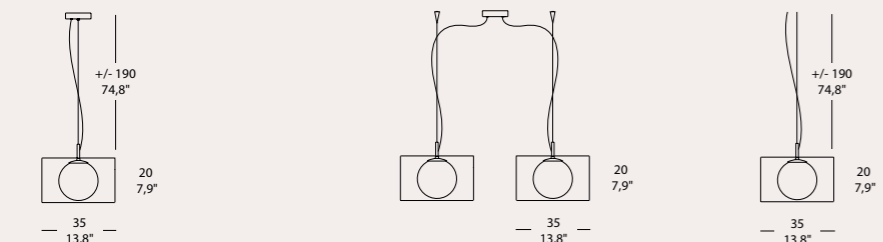

**FOG SO 35**  
1 x MAX 42/53W G9 alo. ENERGY SAVER  
o/or  
1 x MAX 3,5W G9 LED ENERGY SAVER  
CE F IP 20 1 ENEC

**FOG SO 35/2**  
2 x MAX 42/53W G9 alo. ENERGY SAVER  
o/or  
2 x MAX 3,5W G9 LED ENERGY SAVER  
CE F IP 20 1 ENEC

**FOG SO 35 S/R**  
1 x MAX 42/53W G9 alo. ENERGY SAVER  
o/or  
1 x MAX 3,5W G9 LED ENERGY SAVER  
CE F IP 20 1 ENEC

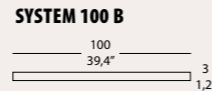

**SYSTEM 100 B**  
150 / 59.1 inches  
3 / 1.2 inches  
CE F IP 20

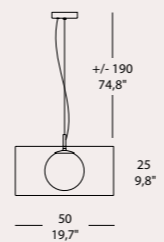

**FOG SO 50**  
1 x MAX 70W E27 alo. ENERGY SAVER  
o/or  
1 x MAX 12W E27 LED ENERGY SAVER  
CE F IP 20 1 ENEC

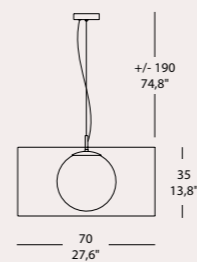

**FOG SO 70**  
1 x MAX 105W E27 alo. ENERGY SAVER  
o/or  
1 x MAX 21W E27 LED ENERGY SAVER  
CE F IP 20 1 ENEC

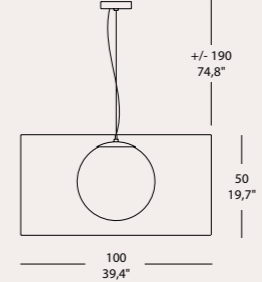

**FOG SO 100**  
1 x MAX 140W E27 alo. ENERGY SAVER  
o/or  
1 x MAX 21W E27 LED ENERGY SAVER  
CE F IP 20 1 ENEC

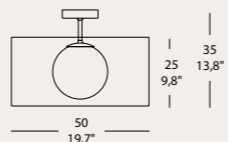

**FOG PL 50**  
1 x MAX 70W E27 alo. ENERGY SAVER  
o/or  
1 x MAX 12W E27 LED ENERGY SAVER  
CE F IP 20 1 ENEC

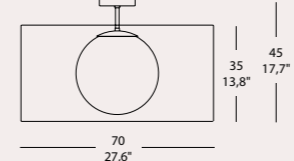

**FOG PL 70**  
1 x MAX 105W E27 alo. ENERGY SAVER  
o/or  
1 x MAX 21W E27 LED ENERGY SAVER  
CE F IP 20 1 ENEC

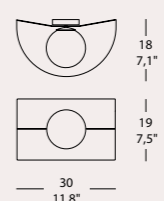

**FOG PA 30**  
1 x MAX 42/53W G9 alo. ENERGY SAVER  
o/or  
1 x MAX 3,5W G9 LED ENERGY SAVER  
CE F IP 40 1 ENEC

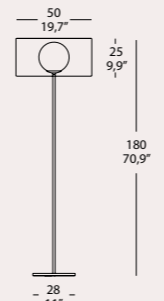

**FOG TE**  
1 x MAX 105W E27 alo. ENERGY SAVER  
o/or  
1 x MAX 14,5W E27 LED DIM ENERGY SAVER  
CE F IP 20 DIM 1 ENEC

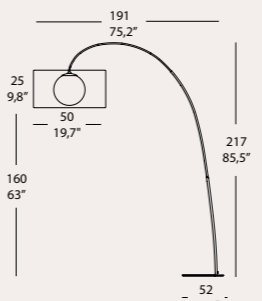

**FOG TE A**  
1 x MAX 105W E27 alo. ENERGY SAVER  
o/or  
1 x MAX 14,5W E27 LED DIM ENERGY SAVER  
CE F IP 20 DIM 1 ENEC

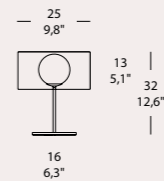

**FOG CO**  
1 x MAX 42/53W G9 alo. ENERGY SAVER  
o/or  
1 x MAX 3,5W G9 LED ENERGY SAVER  
CE F IP 20 1 ENEC



# FOG PLISSÉ

design\_Andrea Lazzari  
Massimo Tonetto

Semplice, discreta, elegante.

Essential, subtle, refined.



Fog Plissé\_TE A



Fog Plissé\_PL 50



Fog Plissé\_PA 30



Fog Plissé\_SO 70



Fog Plissé\_TE



Fog Plissé\_CO

# FOG PLISSÉ

## \_technical data

La collezione Fog Plissé unisce raffinata eleganza e funzionalità. Queste lampade creano una gradevole luce diffusa, grazie al loro paralume in tessuto plissettato e al diffusore interno di forma sferica in vetro soffiato.

Semplice e discreta ma allo stesso tempo elegante, Fog Plissé si adatta ai grandi spazi e a qualsiasi tipo di arredamento domestico e contract, grazie alla possibilità di creare modelli su misura.

La collection Fog Plissé mêle l'élégance raffinée et la fonctionnalité. Ces lampes créent une lumière diffuse agréable, grâce à leur abat-jour en tissu plissé et à un diffuseur interne de forme sphérique en verre soufflé.

Simple et discrète mais en même temps élégante, Fog Plissé s'adapte aux grands espaces et à tout type de décoration résidentielle et collective grâce à la possibilité de créer des modèles sur mesure.

"Fog plissé" collection joins refined elegance with functionality. These lamps create a beautiful diffused light, thanks to their Plisse fabric shade and to an internal blown glass globe diffuser. Simple, moderate but at the same time very elegant, "Fog Plissé" adapts itself to the great outdoors and to all kinds of home furnishings and contracts with the ability to create customized models.

La colección Fog Plissé combina elegancia y funcionalidad. Estas lámparas crean una luz difusa agradable, gracias a su pantalla de tela plisada y a un difusor de forma esférica en vidrio soplado. Simple y discreta pero al mismo tiempo elegante, Fog Plissé se adapta a grandes espacios y cualquier tipo de muebles domésticos y contract gracias a la posibilidad de crear modelos a la medida.

Die Kollektion Fog Plissé vereint eine außergewöhnliche Eleganz und Funktionalität. Diese Lampen bilden einen angenehmen diffusen Lichteft, dank des Lampenschirms aus plisziertem Stoff und eines internen kugelförmigen Diffusors aus geblasenem Glas. Einfach und diskret, aber auch gleichzeitig elegant. Fog Plissé passt sich großen Räumen, jeder häuslichen und Contract-Einrichtungsart an, dank der Möglichkeit maßgeschneiderte Modelle zu kreieren.

Коллекция Fog Plissé объединяет утонченную элегантность и функциональность.

Этот светильник создает прятный рассеянный свет, благодаря плиссированному абажуру и внутреннему рассеивателю из дутого стекла в форме шара.

Простая и скромная, но в тоже время элегантная, Fog Plissé, благодаря своей возможности создавать модели по индивидуальным размерам, прекрасно подходит для больших пространств, для любых интерьеров частных и общественных помещений.

**Struttura:** metallo nichel satinato, disponibile nelle varianti bianco opaco e nero opaco per la sola versione da terra ad arco.

**Diffusore:** vetro soffiato bianco latte satinato e paralumi in tessuto Pongé nei colori: avorio, bianco, nero e moka. Ignifugo classe 1.

**Frame:** satin finished nickel metal, available also in matt white and matt black only for the arc floor version.

**Diffuser:** milkwhite frosted blown glass and Pongé fabric lampshades available in these colors: ivory, white, black and moka. Class 1 fire-proof.

**Struktur:** Metall nickelsatiniert, mattweiß und mattschwarz nur für die Boden-Bogenlampe erhältlich.

**Diffusor:** Satiniertes, milchweißes geblasenes Glas und Lampenschirme aus Pongé-Stoff in den Farben: Eifenbein, Weiß, Schwarz und Mokka. Feuerfest Klasse 1.

**Structure:** métal nickel satiné, fourni dans les variantes blanc mat et noir mat uniquement pour le lampadaire en arc.

**Difusor:** verre soufflé blanc lait satiné et abat-jour en tissu Pongé dans les coloris blanc, noir, ivoire et moka. Ignifuge classe 1.

**Estructura:** metal níquel satinado, disponible en las variables blanco opaco y negro opaco solo para la versión de pie a arco.

**Difusor:** vidrio soplado blanco leche satinado y pantallas en tejido Pongé en los colores: marfil, blanco, negro y moca. Ignifugo clase 1.

**Структура:** сатинированный никель.

Для торшера, в виде арки, может быть выполнена также в матовом белом или матовом черном цветах.

**Рассеиватель:** дутое матовое стекло молочного белого цвета; абажуры из ткани Pongé белого, черного и темно-коричневого цвета и цвета слоновой кости. Огнестойкая ткань класса 1.



**BI:** Bianco/White



**AV:** Avorio/Ivory

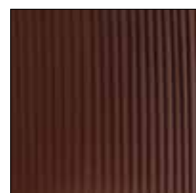

**MK:** Moka/Moka

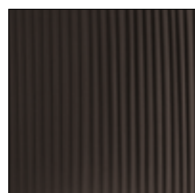

**NO:** Nero/Black

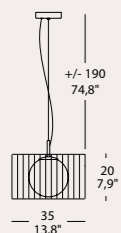

### FOG PLISSÉ SO 35

1 x MAX 42/53W G9 alo. ENERGY SAVER

o/or

1 x MAX 3,5W G9 LED

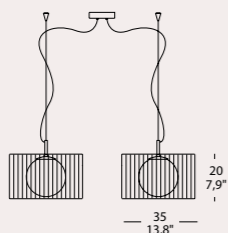
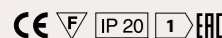

### FOG PLISSÉ SO 35/2

2 x MAX 42/53W G9 alo. ENERGY SAVER

o/or

2 x MAX 3,5W G9 LED

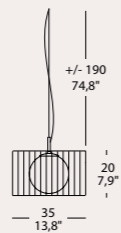
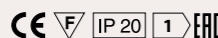

### FOG PLISSÉ SO 35 S/R

1 x MAX 42/53W G9 alo. ENERGY SAVER

o/or

1 x MAX 3,5W G9 LED

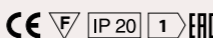

### SYSTEM 100 B

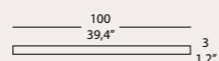

### SYSTEM 150 B

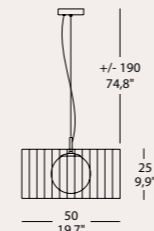
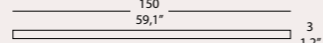

### FOG PLISSÉ SO 50

1 x MAX 70W E27 alo. ENERGY SAVER

o/or

1 x MAX 12W E27 LED

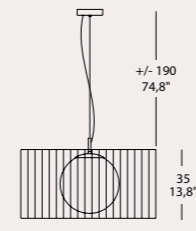
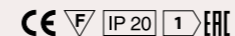

### FOG PLISSÉ SO 70

1 x MAX 105W E27 alo. ENERGY SAVER

o/or

1 x MAX 21W E27 LED

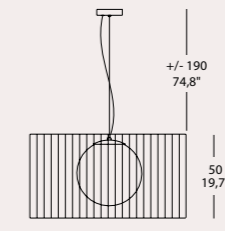
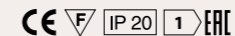

### FOG PLISSÉ SO 100

1 x MAX 140W E27 alo. ENERGY SAVER

o/or

1 x MAX 21W E27 LED

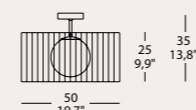

### FOG PLISSÉ PL 50

1 x MAX 70W E27 alo. ENERGY SAVER

o/or

1 x MAX 12W E27 LED

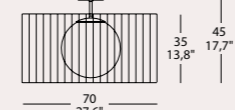
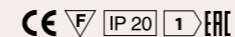

### FOG PLISSÉ PL 70

1 x MAX 105W E27 alo. ENERGY SAVER

o/or

1 x MAX 21W E27 LED

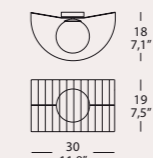
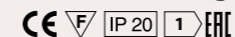

### FOG PLISSÉ PA 30

1 x MAX 42/53W G9 alo. ENERGY SAVER

o/or

1 x MAX 3,5W G9 LED

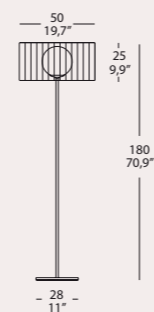

### FOG PLISSÉ TE

1 x MAX 105W E27 alo. ENERGY SAVER

o/or

1 x MAX 14,5W E27 LED DIM

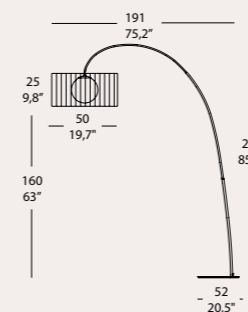
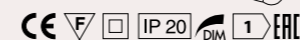

### FOG PLISSÉ TE A

1 x MAX 105W E27 alo. ENERGY SAVER

o/or

1 x MAX 14,5W E27 LED DIM

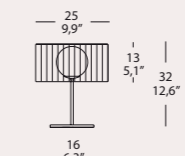
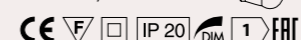

### FOG PLISSÉ CO

1 x MAX 42/53W G9 alo. ENERGY SAVER

o/or

1 x MAX 3,5W G9 LED







# RIBBON

design\_Andrea Lazzari

Incontro tra luce e movimento.

The coupling of radiance  
and motion.



Ribbon\_SO 40/2



Ribbon\_TE



Ribbon\_TE A



Ribbon\_CO



Ribbon\_PL 80



Ribbon\_PA 40

# RIBBON

## \_technical data

Ribbon è l'incontro tra la luce e il movimento, tra chiaro e scuro, tra stile moderno e tradizione.

Con Ribbon, Morosini ha voluto riprendere il filo della conoscenza e della sapienza italiana nella lavorazione manuale del tessuto. Fettucce di stoffa setata, avvolte interamente a mano attorno a una struttura metallica, creano un effetto visivo unico grazie anche all'uso di un diffusore in vetro soffiato che appare e scompare ruotando visivamente attorno al paralume. Una collezione di lampade formale e sperimentale nello stesso tempo, disponibile in più versioni, per arredare con eleganza e creatività ogni ambiente.

Ribbon représente la rencontre entre la lumière et le mouvement, entre le clair et l'obscur, entre le style moderne et la tradition. Avec Ribbon, Morosini a voulu reprendre le fil de la connaissance et du savoir italien dans le travail manuel du tissu. Des bandes d'une étoffe soyeuse, entièrement enveloppés à la main autour d'une structure métallique, créent un effet visuel unique grâce également à l'utilisation d'un diffuseur en verre soufflé qui apparaît et disparaît en pivotant autour de l'abat-jour. Une collection de lampes à la fois formelle et expérimentale, disponible en plusieurs versions, pour décorer toute pièce avec élégance et créativité.

Ribbon is the meeting between light and movement, between light and dark, between modern and traditional style. Through Ribbon, Morosini picked up the thread of knowledge and wisdom in the Italian manual tissue processing. Silky strips of cloth wrapped entirely by hand around a metal structure, create a unique visual effect thanks to the use of a diffuser in blown glass that appears and disappears visually turning around the lampshade. A collection of lamps at the same time formal and experimental, available in several versions, suitable to furnish with elegance and creativity each kind of space.

Ribbon es el encuentro entre la luz y el movimiento, entre claro y oscuro, entre estilo moderno y tradición. Con Ribbon, Morosini ha querido reanudar el hilo del conocimiento y de la sabiduría italiana en el trabajo manual del tejido. Tiras de tela de seda, envueltas por el interior a mano alrededor de una estructura metálica, crean un efecto visivo único gracias también al uso de un difusor en vidrio soplado que aparece y desaparece girando alrededor de la pantalla. Una colección de lámparas formal y experimental al mismo tiempo, disponible en varias versiones, para decorar todo ambiente con elegancia y creatividad.

Ribbon ist das Zusammentreffen zwischen Licht und Bewegung, zwischen Hell und Dunkel, zwischen modernem Stil und Tradition. Mit Ribbon hat Morosini die Erfahrung und das Wissen der manuellen italienischen Stoffverarbeitung wieder aufnehmen wollen. Seidenstoffbänder, die von Hand ganz um eine Metallstruktur gewunden werden, kreieren einen einzigartigen visuellen Effekt auch dank der Anwendung eines Diffusors aus geblasenem Glas, der durch Drehen um den Lampenschirm erscheint und verschwindet. Eine formale und experimentelle Lampenkollektion, die in mehreren Versionen erhältlich ist, um mit Eleganz und Kreativität jede Umgebung einzurichten.

Ribbon – это встреча света и движения, светлого и темного, современного стиля и традиции. В своей коллекции Ribbon Morosini решил возобновить итальянские знания и умения в области ручной работы с тканью. Ленточки из шелковой ткани, вручную обернутые вокруг металлической структуры, создают уникальный визуальный эффект, благодаря рассеивателю, выполненному в виде сферы из дутого стекла, которая кажется пропадающей из вида и вновь появляющейся при вращении вокруг абажура. Коллекция светильников формальная и в то же время экспериментальная, доступна в различных версиях, для элегантного и креативного оформления любого пространства.

**Struttura:** metallo nichel satinato, disponibile nelle varianti bianco opaco e nero opaco per la sola versione da terra ad arco.

**Diffusore:** vetro soffiato bianco latte satinato e paralumi in nastro setato nei colori: avorio, bianco, nero e moka.

**Frame:** satin finish nickel metal, available also in matt white and matt black only for the arc floor version.

**Diffuser:** milkwhite frosted blown glass and silky ribbon colors: ivory, white, black and moka.

**Struktur:** Metall nickelsatiniert, mattweiß und mattschwarz nur für die Boden-Bogenlampe erhältlich.

**Diffusor:** Satiniertes, milchweißes geblasenes Glas und Lampenschirme aus Seidenbändern in den Farben: Effenbein, Weiß, Schwarz und Mokka.

**Structure:** métal nickel satinée, fourni dans les variantes blanc mat et noir mat uniquement pour le lampadaire en arc.

**Diffusor:** verre soufflé blanc lait satiné et abat-jour réalisé avec un ruban soyeux dans les orlors blanc, noir et moka.

**Estructura:** metal níquel satinado, disponible en las variables blanco opaco y negro opaco solo para la versión de pie a arco.

**Difusor:** vidrio soplado blanco leche satinado y pantallas de cinta de seda en los colores: marfil, blanco, negro y moca.

**Структура:** сатинированный никель. Для торшера, в виде арки, может быть выполнена также в матовом белом или матовом черном цветах.

**Рассеиватель:** дутое матовое стекло молочного белого цвета; абажуры из ленточек из шелковой ткани могут быть выполнены в цвете слоновой кости, белом, черном или темно-коричневом цветах.



**BI:** Bianco/White    **AV:** Avorio/Ivory    **MK:** Moka/Moka    **NO:** Nero/Black

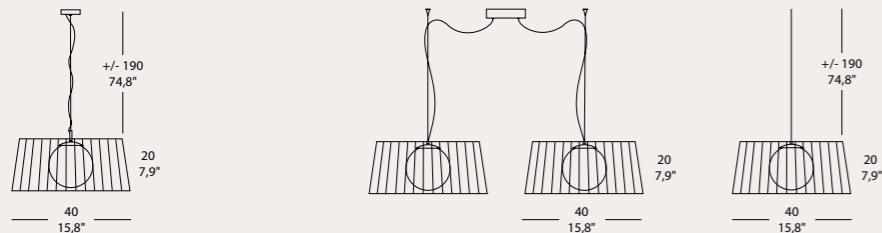

**RIBBON 50 40**  
1 x MAX 42/53W G9 alo. ENERGY SAVER  
o/or  
1 x MAX 3,5W G9 LED ENERGY SAVER  
CE F IP 20 1 EAC

**RIBBON 50 40/2**  
2 x MAX 42/53W G9 alo. ENERGY SAVER  
o/or  
2 x MAX 3,5W G9 LED ENERGY SAVER  
CE F IP 20 1 EAC

**RIBBON 50 40 5/R**  
1 x MAX 42/53W G9 alo. ENERGY SAVER  
o/or  
1 x MAX 3,5W G9 LED ENERGY SAVER  
CE F IP 20 1 EAC

**SYSTEM 100 B**  
100 39,4" 3 1,2"

**SYSTEM 150 B**  
150 59,1" 3 1,2"  
CE F IP 20

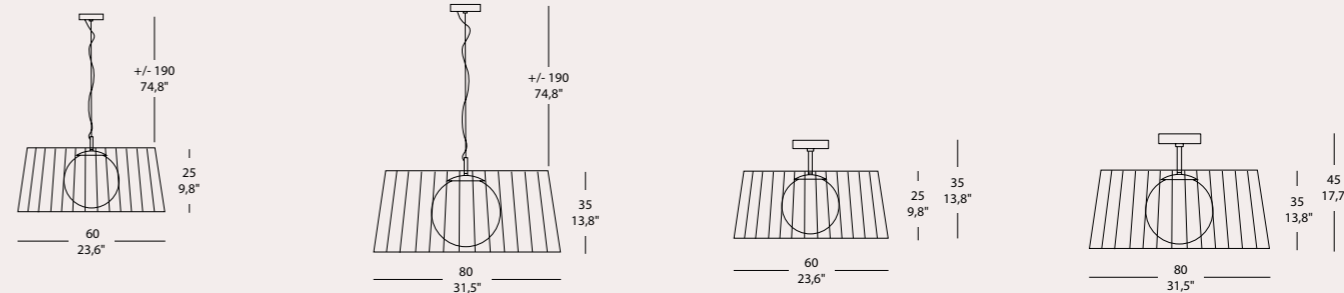

**RIBBON 50 60**  
1 x MAX 70W E27 alo. ENERGY SAVER  
o/or  
1 x MAX 12W E27 LED ENERGY SAVER  
CE F IP 20 1 EAC

**RIBBON 50 80**  
1 x MAX 105W E27 alo. ENERGY SAVER  
o/or  
1 x MAX 21W E27 LED ENERGY SAVER  
CE F IP 20 1 EAC

**RIBBON PL 60**  
1 x MAX 70W E27 alo. ENERGY SAVER  
o/or  
1 x MAX 12W E27 LED ENERGY SAVER  
CE F IP 20 1 EAC

**RIBBON PL 80**  
1 x MAX 105W E27 alo. ENERGY SAVER  
o/or  
1 x MAX 21W E27 LED ENERGY SAVER  
CE F IP 20 1 EAC

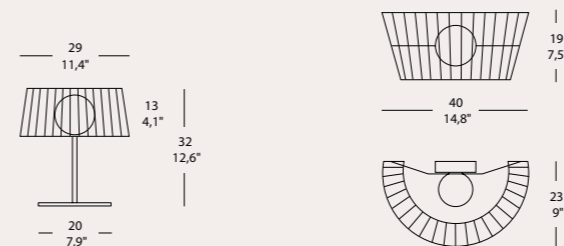

**RIBBON CO**  
1 x MAX 42/53W G9 alo. ENERGY SAVER  
o/or  
1 x MAX 3,5W G9 LED ENERGY SAVER  
CE F IP 20 1 EAC

**RIBBON PA 40**  
1 x MAX 42/53W G9 alo. ENERGY SAVER  
o/or  
1 x MAX 3,5W G9 LED ENERGY SAVER  
CE F IP 40 1 EAC

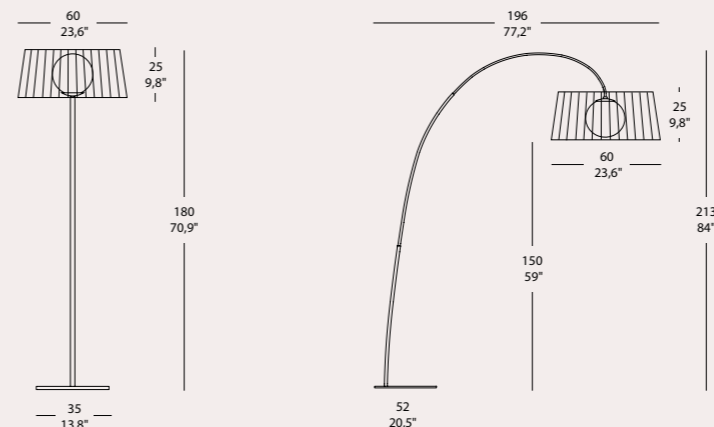

**RIBBON TE**  
1 x MAX 105W E27 alo. ENERGY SAVER  
o/or  
1 x MAX 14,5W E27 LED DIM ENERGY SAVER  
CE F IP 20 DIM 1 EAC

**RIBBON TE A**  
1 x MAX 105W E27 alo. ENERGY SAVER  
o/or  
1 x MAX 14,5W E27 LED DIM ENERGY SAVER  
CE F IP 20 DIM 1 EAC



# DIAMOND

design\_Sandro Santantonio



Una gemma di design.

A splendid design gem.



Diamond\_SO 120

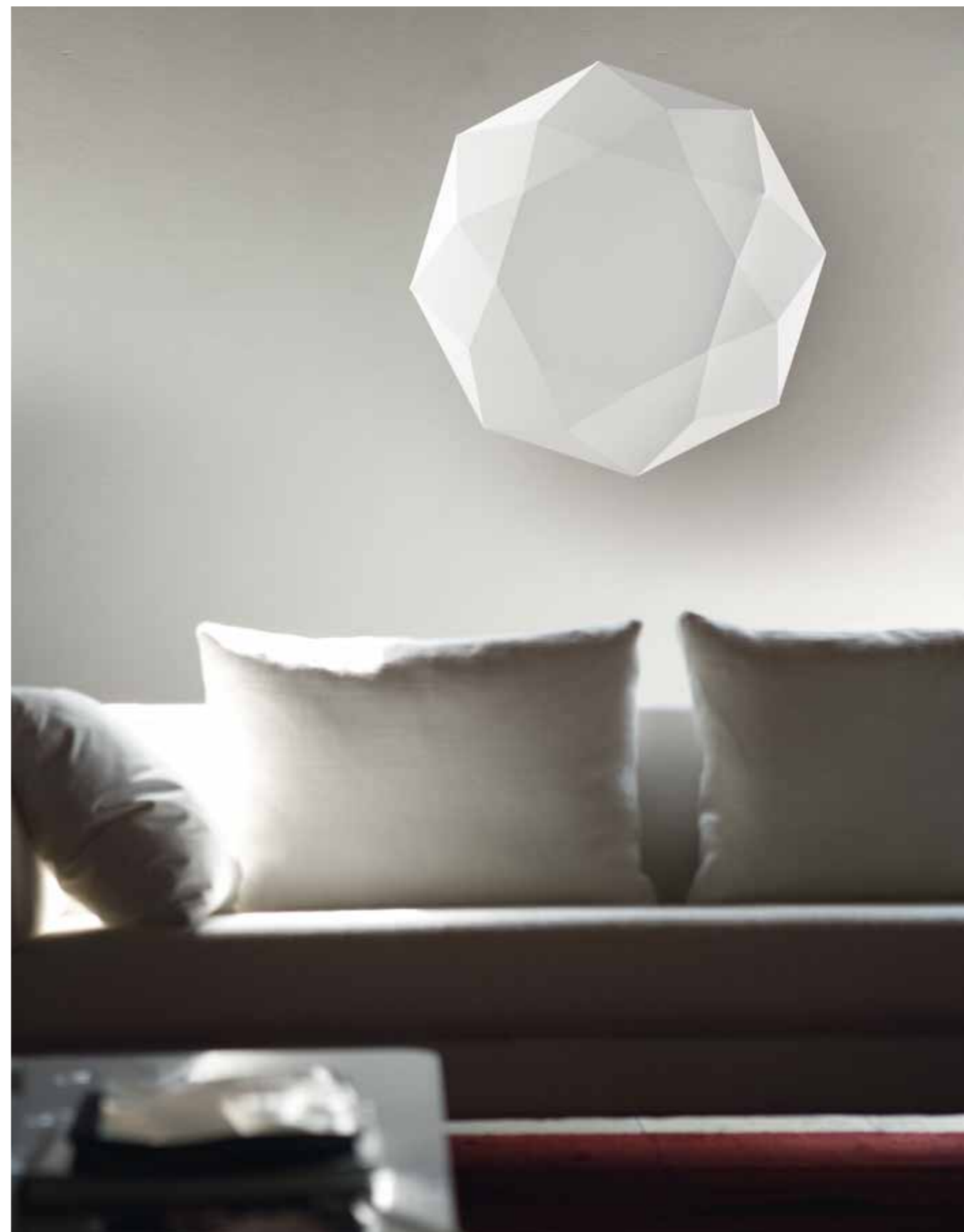

Diamond\_PP 80

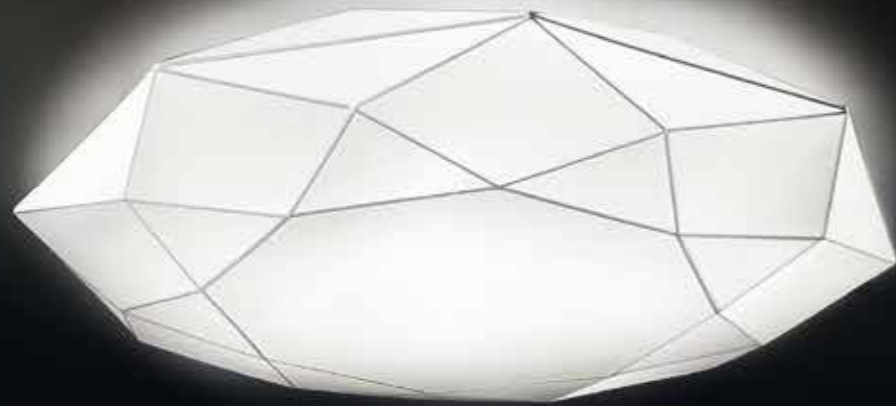

# DIAMOND

## \_technical data

Una lampada dall'eleganza purissima. Una gemma di design incastonata nello spazio. La collezione Diamond comprende molteplici tagli e dimensioni, che rappresentano le mille facce della stessa brillante idea. Come lampada a sospensione, Diamond assume l'aspetto di una nuvola di luce, lasciando trasparire tutta la leggerezza del suo tessuto. Come lampada da parete, infine, Diamond cattura immediatamente lo sguardo per la sua rara originalità. Dedicato all'arredamento moderno, un oggetto di design in grado di brillare di luce propria.

Une lampe d'une élégance purissime. Une étoile de design enchâssée dans l'espace. La collection Diamond présente de nombreuses tailles et dimensions, qui représentent les mille facettes de la même idée brillante. En tant que lampe à suspension, Diamond prend l'aspect d'un nuage de lumière, laissant apparaître toute la légèreté de son tissu. Enfin, en tant qu'applique, l'originalité rare de Diamond capture immédiatement le regard. Dédié à la décoration moderne, cet objet de design est en mesure de briller de ses propres feux.

A lamp of pure elegance. A design gem set in space. The Diamond collection includes various cuts and sizes, representing the many faces of the same brilliant idea. As pendant lamp, Diamond seems to be a cloud of light, that reveals all the lightness of the fabric. In conclusion, Diamond, as wall lamp, catches immediately the eye thanks to its rare originality. A design element that shines in its own light, dedicated to modern furniture.

Una lámpara de elegancia purísima. Una joya de diseño engastada en el espacio. La colección incluye múltiples cortes y dimensiones, que representan las mil caras de la misma idea brillante. Como lámpara colgante, Diamond toma la apariencia de una nube de luz, dejando trasparer toda la ligereza de su tejido. Como lámpara de pared, finalmente, Diamond cautiva inmediatamente la atención por su rara originalidad. Dedicado a la decoración moderna, un objeto de diseño puede brillar por su propia luz.

Eine Lampe mit reiner Eleganz. Ein im Raum eingelassener Design-Edelstein. Die Kollektion Diamond schließt zahlreiche Schritte und Dimensionen ein, die die tausenden Facetten derselben brillanten Idee darstellen. Als Hängelampe übernimmt Diamond den Aspekt einer Lichtwolke und lässt die ganze Leichtigkeit ihres Gewebes durchscheinen. Als Wandlampe hingegen zieht Diamond dank ihrer seltenen Originalität sofort den Blick auf sich. Sie ist dem modernen Einrichtungsstil gewidmet, ein Designobjekt das mit eigenem Licht glänzt.

Светильник абсолютной элегантности. Это жемчужина дизайна, вставленная в оправу пространства. Коллекция Diamond содержит в себе множество граней и размеров, которые представляют тысячу аспектов одной и той же превосходной идеи. Подвесной светильник Diamond принимает форму облака света, позволяя просвечивать всю легкость ткани. Настенный светильник Diamond мгновенно притягивает взгляд благодаря своей редкой оригинальности. Эти элементы декора, предназначенные для установки в современных интерьерах и способные дарить свой блестящий свет.

**Struttura:** metallo bianco opaco. **Frame:** matt white metal.  
**Diffusore:** lycra elasticizzata bianca, sfoderabile e lavabile. **Diffuser:** white stretch removable and washable lycra.

**Struktur:** Metall mattweiß.  
**Diffusor:** Weißes, elastisches Lycra, abzieh- und waschbar.

**Structure:** métal blanc mat.  
**Diffuseur:** lycra élastique blanc, déhoussable et lavable.

**Estructura:** metal blanco opaco. **Структура:** белый блестящий металл.  
**Рассеиватель:** белая эластичная лайкра, которая снимается и стирается.

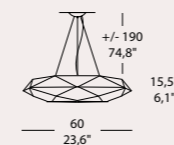

### DIAMOND 50 60

2 x MAX 53W E27 alo. ENERGY SAVER  
o/or  
2 x Max 8W E27 LED LED  
**CE** **F** **IP 20** **1** **ERC**

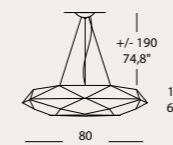

### DIAMOND 50 80

3 x MAX 70W E27 alo. ENERGY SAVER  
o/or  
3 x Max 12W E27 LED LED  
**CE** **F** **IP 20** **1** **ERC**

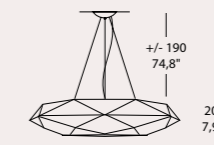

### DIAMOND 50 120

3 x MAX 70W E27 alo. ENERGY SAVER  
o/or  
3 x Max 12W E27 LED LED  
**CE** **F** **IP 20** **1** **ERC**

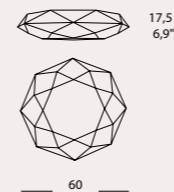

### DIAMOND PP 60

2 x MAX 53W E27 alo. ENERGY SAVER  
o/or  
2 x Max 8W E27 LED LED  
**CE** **F** **IP 20** **1** **ERC**

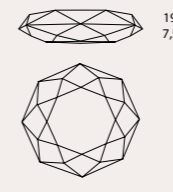

### DIAMOND PP 80

3 x MAX 70W E27 alo. ENERGY SAVER  
o/or  
3 x Max 12W E27 LED LED  
**CE** **F** **IP 20** **1** **ERC**

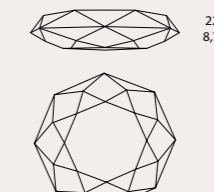

### DIAMOND PP 120

3 x MAX 70W E27 alo. ENERGY SAVER  
o/or  
3 x Max 12W E27 LED LED  
**CE** **F** **IP 20** **1** **ERC**

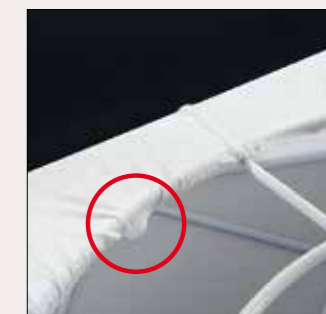





# IN & OUT

design\_ Andrea Lazzari

Delicati volumi contemporanei.

Refined contemporary lines.



## IN &amp; OUT

\_technical data

**Design & Artigianato, Semplicità & Eleganza, Tessuto & Luce:** in una parola, In & Out. L'essenzialità estetica della lampada nasconde in verità una sofisticata ricerca progettuale e una sapienza produttiva ai massimi livelli.

Le parti metalliche centrali sono rimovibili e possono essere montate in due diverse posizioni, in modo da poter cambiare il disegno centrale della lampada.

Il design diventa così unico, esclusivo, arredando con la stessa forza espressiva di un'opera d'arte contemporanea.

**Design et Artisanat, Simplicité et Élégance, Tissu et Lumière :** en un mot, In & Out. Le caractère esthétique essentiel de la lampe cache en vérité une recherche conceptuelle sophistiquée et une capacité de production au plus haut niveau.

Les pièces métalliques centrales sont amovibles et elles peuvent être montées dans deux positions différentes, afin de changer le design central de la lampe. Ainsi le design devient unique, exclusif, décorant avec la même force d'expression qu'une œuvre d'art contemporaine.

**Design & Craftsmanship, Elegance & Simplicity, Fabric & Light:** in a word, In & Out. The aesthetic essentiality of the lamp actually hides a sophisticated design research and a productive knowledge at the highest levels.

The central metal parts are removable and can be assembled in two different positions, in order to change the central drawing of the lamp.

In this way, the design becomes unique and exclusive, furnishing with the same expressive power of a contemporary artwork.

**Design & Artesanía, Simplicidad & Elegancia, Tejido & Luz:** en pocas palabras, In & Out. La esencialidad estética de la lámpara esconde en realidad una sofisticada búsqueda proyectual y una sabiduría productiva a los máximos niveles.

Los componentes metálicos centrales son amovibles y se pueden montar de dos maneras diferentes, ofreciendo la posibilidad de cambiar el diseño central de la lámpara.

El design se vuelve así único, exclusivo, decorando con la misma fuerza expresiva de una obra de arte contemporánea.

**Design & Handwerk, Einfachheit & Eleganz, Stoff & Licht.** In einem Wort: In & Out. Die ästhetische Grundsätzlichkeit dieser Lampe verbirgt in Wirklichkeit eine ausgeklügelte Konstruktion und ein Produktionswissen auf höchster Ebene. Die mittigen Metallteile sind abnehmbar und können zur Variation des zentralen Lampenmusters in zwei verschiedenen Stellungen montiert werden. Das Design wird dadurch einzigartig, exklusiv und richtet mit derselben Ausdruckskraft eines zeitgenössischen Kunstwerks ein.

**Дизайн и Архитектура, Простота и Элегантность, Ткань и Свет:** одним словом, In & Out. За эстетической сущности светильника скрываются, в действительности, современная проектно-исследовательская работа и продуктивные знания на самом высоком уровне. Центральные металлические части снимаются и могут быть установлены в двух различных позициях для изменения дизайна центральной части лампы. Таким образом, дизайн становится уникальным и единственным, способным украсить интерьер с такой же силой экспрессии, как и произведение современного искусства.

**Struttura:** metallo bianco lucido.  
**Diffusore:** lycra elasticizzata bianca o avorio, sfoderabile e lavabile. Solo nella versione AL, vetro bianco interno.

**Frame:** white polished finish metal.  
**Diffuser:** white or ivory stretch removable and washable lycra. Only for the AL version white glass inside.

**Struktur:** Metall glänzend Weiß.  
**Diffusor:** Elastisches Lycra, Weiß oder Elfenbein, abzieh- und waschbar. Nur in der Version AL, internes weißes Glas.

**Structure:** métal blanc brillant.  
**Diffuseur:** lycra élastique blanc ou ivoire, déhoussable et lavable. Uniquement dans la version AL, verre blanc interne.

**Estructura:** metal blanco brillante.  
**Difusor:** lycra elástica blanca o marfil, desenfundable y lavable. Solo en la versión AL, vidrio blanco interno.

**Структура:** белый блестящий металл.  
**Рассеиватель:** абажур из эластичной ткани, которую можно снимать и стирать. Ткань предлагается в следующих вариантах цвета: белый и цвет слоновой кости. В версии AL имеется внутренний рассеиватель из белого стекла.

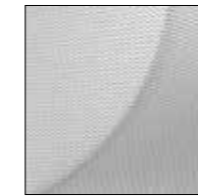

BI: Bianco/White



AV: Avorio/Ivory

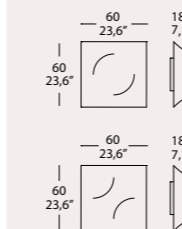

IN &amp; OUT PP 60 FL

2 x Max 12W E27 LED

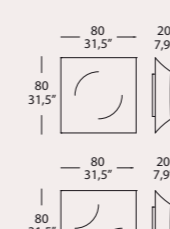

IN &amp; OUT PP 80 FL

3 x Max 21W E27 LED

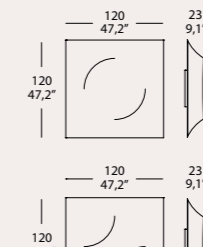

IN &amp; OUT PL 120 FL

3 x Max 21W E27 LED





# DICE

design\_Andrea Lazzari

Dentro la scatola magica.

The bright magic box.



## DICE

\_technical data

Un piccolo cubo di luce e creatività, originale nella forma e nella tecnica di produzione. Le singole facce del cubo, biselate con taglio a 45°, sono incollate con una tecnica ai raggi UV, che esalta lo spessore e la trasparenza del vetro extrachiaro, serigrafato internamente di colore bianco. Un effetto ricercato per mettere in evidenza la preziosità del cristallo e degli spigoli vivi. Il risultato è un piccolo capolavoro di artigianato, la cui grandezza è proprio nei dettagli. Disponibile anche a LED.

Un petit cube de lumière et de créativité, original au niveau de la forme de la technique de production. Les seules faces du cube, biseautées avec une coupe à 45°, sont collées moyennant une technique aux rayons UV, qui exalte l'épaisseur et la transparence du verre extra clair, sérigraphié en blanc à l'intérieur. Un effet recherché pour mettre en évidence la préciosité du cristal et des arêtes vives. Le résultat est un petit chef-d'œuvre d'artisanat, dont la grandeur est justement dans les détails. Egalement disponible dans la version à LED.

A small cube of light and creativity, with an original form and created using an original technique. The single faces of the cube are glued through a UV-technique, with a bevel of 45°, which enhances the thickness and transparency of the extra clear glass, which is white silk screen printed inside. A desired effect to highlight the preciousness of the crystal and sharp edges. The result is a masterpiece of craftsmanship, whose greatness is in details. Available also with LED.

Un pequeño cubo de luz y creatividad, original en la forma y en la técnica de producción. Cada una de las caras individuales del cubo, biseladas con corte a 45°, están pegadas con una técnica de rayos UV, que exalta el espesor y la transparencia del vidrio extra claro, serigrafiado de color blanco por el interior. Un efecto rebuscado para resaltar la preciosidad del cristal y los cantos vivos. El resultado es una pequeña obra maestra de artesanía, cuya grandeza está en los detalles. Disponible también en versión LED.

Ein kleiner aus Licht und Kreativität bestehender Würfel, originell in seiner Form und Herstellungstechnik. Die einzelnen Würfelseiten, die auf 45° abgeschrägt sind, wurden mit einer UV-Strahlentechnik verklebt und heben die Stärke und Transparenz des extrahellen, intern weiß siebgedruckten Glases hervor. Ein gewünschter Effekt, um die Kostbarkeit des Kristalls und der Kanten hervorzuheben. Das Ergebnis ist ein kleines Meisterstück des Handwerks, dessen Größe in den Details liegt. Erhältlich auch in der Version mit LED.

Маленький куб света и креативности, характеризующийся оригинальной формой и техникой исполнения.

Грани куба, скошенные под углом 45°, склеены по технике склеивания стекла с УФ отверждением, подчеркивающей толщину и абсолютную прозрачность стекла. Белый цвет внутренней части стекла получен с помощью шелкографии. Изысканный эффект позволяет подчеркнуть ценность хрустля и его острых граней. Результат - маленький шедевр ремесла, заключающегося в своих деталях величии. Доступна также и версия LED.

**Struttura:** metallo nichel satinato e alluminio anodizzato.

**Diffusore:** vetro extrachiaro lucido con serigrafia bianca.

**Frame:** satin nickel - anodized aluminum metal.

**Diffuser:** extra- clear glass with polished white silkscreen.

**Struktur:** Metall nickelsatiniert und Alu-eloxiert.

**Diffusor:** Glänzendes, extrahelles Glas mit weißem Siebdruck.

**Structure:** métal nickel satiné et aluminium anodisé.

**Diffuseur:** verre extra clair brillant avec sérigraphie blanche.

**Estructura:** metal níquel satinado y aluminio anodizado.

**Difusor:** vidrio extra claro brillante con serigrafía blanca.

**Структура:** металл сатинированный никель и анодированный алюминий.

**Рассеиватель:** сверхпрозрачное прозрачное блестящее стекло с белой шелкографией.

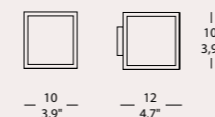
**DICE PP 10**

1 x MAX 33/42W G9 alo. ENERGY SAVER  
o/or  
1 x MAX 3,5W G9 LED

CE IP 40 ENEC

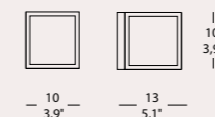
**DICE PP 10 LED**

9,1W 1230Lm 3000K  
Cri>80 220-240Vac 50-60Hz

9,1W 1180Lm 2700K

CE IP 40 ENEC

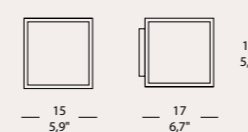
**DICE PP 15**

1 x MAX 70W E27 alo. ENERGY SAVER  
o/or  
1 x Max 6W E27 LED

CE IP 40 ENEC

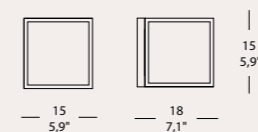
**DICE PP 15 LED**

14,4W 1730Lm 3000K  
Cri>80 220-240Vac 50-60Hz

14,4W 1660Lm 2700K

CE IP 40 ENEC

# ALASKA

design\_Ufficio Stile

Il trasporto di un'emozione  
cristallina.

The allure of a crystalline  
creation.

# ALASKA

## \_technical data

Una forma classica e semplice all'apparenza. Ma è solo la punta dell'iceberg. La lampada Alaska è un esempio di maestria e cura del dettaglio. I vetri delle plafoniere Alaska sono eseguiti artigianalmente con una tecnica di soffio particolare che unisce in un unico corpo il vetro bianco latte a un marcato bordo trasparente, risaltando l'effetto cristallo sullo spigolo vivo. Una finezza produttiva ed estetica capace di farsi notare anche a luce spenta. Disponibile anche a LED.

A classic and simple shape to all appearances. But this is only the tip of the iceberg. The Alaska lamp is the perfect example of craftsmanship and attention to details. The glasses of the ceiling lamp Alaska are handmade through a particular glassblowing technique which combines in one body the milkwhite glass with a marked transparent edge, emphasizing the crystal effect on the sharp corner. A productive and aesthetic finish that has a particular effect even with the light off. Also available with LED.

Eine augenscheinlich klassische und einfache Form. Das ist aber nur die Spitze des Eisbergs. Die Lampe Alaska ist ein Beispiel der Meisterkunst und Liebe zum Detail. Die Gläser der Deckenlampe Alaska werden handwerklich mit einer besonderen Glasbläsereitechnik ausgeführt, die in einem einzigen Körper das milchweiße Glas mit einem markierten transparenten Rand verbindet und so den Kristalleffekt an der Kante hervorhebt. Eine produktive und ästhetische Feinheit, die auch bei ausgeschaltetem Licht auf sich aufmerksam macht. Erhältlich auch in der Version mit LED.

Une forme apparemment classique et simple. Mais ce n'est que la pointe de l'iceberg. La lampe Alaska est un exemple de maîtrise et de soins du détail. Les verres des plafonniers Alaska sont réalisés artisanalement suivant une technique de soufflage particulière qui combine en un seul corps le verre blanc lacté et un bord transparent marqué, mettant en évidence l'effet de cristal sur l'arête vive. Une finesse au niveau de la production de l'esthétique capable de se faire remarquer même lorsque la lumière est éteinte. Egalement disponible dans la version à LED.

Una forma clásica y simple a la apariencia. Pero es sólo la punta del iceberg. La lámpara de Alaska es un ejemplo de la artesanía y la atención en el detalle. Los vidrios de apliques para techo Alaska se hacen artesanalmente con una técnica de sople especial que combina en un solo cuerpo el vidrio blanco leche a un borde marcado transparente, aumentando el efecto cristal en el canto vivo. Una delicadeza productiva y estética para hacerse notar incluso con la luz apagada. Disponible también en versión LED.

На первый взгляд, форма кажется простой и классической, но это всего лишь верхушка айсберга. Светильник Alaska - пример мастерства и заботы о деталях. Стекла плафонов Alaska выполнены традиционным ремесленным способом с использованием особой техники выдувания, при которой белое молочное стекло и очерченный прозрачный край соединяются в одно целое, усиливая при таком контрасте эффект хрустала. Эстетичный вид и изящность работы способны привлечь к себе внимание даже в выключенном состоянии. Доступна также и версия LED.

**Struttura:** metallo bianco lucido.  
**Diffusore:** vetro soffiato bianco latte lucido con bordo in cristallo trasparente.

**Frame:** white polished finish metal.  
**Diffuser:** milkwhite blown glass polished finish with transparent crystal edge.

**Struktur:** Metall glänzend Weiß.  
**Diffusor:** Geblasenes, glänzend milchweißes Glas, mit Kante aus transparentem Kristall.

**Structure:** métal blanc brillant.  
**Diffuseur:** verre soufflé blanc lait brillant avec bord en cristal transparent.

**Estructura:** blanco brillante.  
**Difusor:** vidrio soplado blanco leche de brillante con borde en cristal transparente.

**Структура:** белый блестящий металл.  
**Рассеиватель:** дутое блестящее белое стекло с хрустальной прозрачной кромкой.

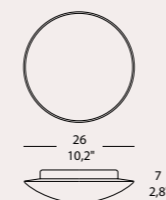

### ALASKA/PP 26

1 x MAX 42W E27 alo. ENERGY SAVER  
o/or  
1 x Max 6W E27 LED LED  
**CE** **F** **IP 40** **ADA** **1** **ERC**

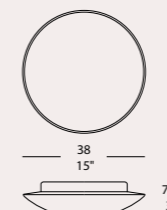

### ALASKA/PP 38

2 x MAX 42W E27 alo. ENERGY SAVER  
o/or  
2 x Max 6W E27 LED LED  
**CE** **F** **IP 40** **ADA** **1** **ERC**

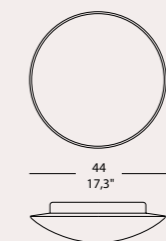

### ALASKA/PP 44

3 x MAX 42W E27 alo. ENERGY SAVER  
o/or  
3 x Max 6W E27 LED LED  
**CE** **F** **IP 40** **ADA** **1** **ERC**

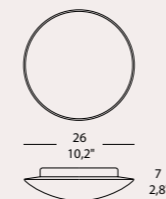

### ALASKA/PP 26 LED

7,5W 930Lm 3000K  
Cri>80 220-240Vac 50-60Hz LED  
**CE** **F** **IP 40** **ADA** **3** **ERC**

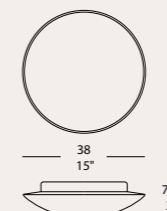

### ALASKA/PP 38 LED

12,6W 1980Lm 3000K  
Cri>80 220-240Vac 50-60Hz LED  
**CE** **F** **IP 40** **ADA** **3** **ERC**

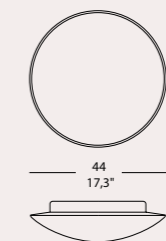

### ALASKA/PP 44 LED

18,7W 2750Lm 3000K  
Cri>80 220-240Vac 50-60Hz LED  
**CE** **F** **IP 40** **ADA** **3** **ERC**





# EGG

design\_Ufficio Stile

Il piacere di una sorpresa  
di luce.

A pleasant surprise of light.



Egg\_SO 1



Egg\_SO 2

# EGG

## \_technical data

Nella sua semplicità, la lampada Egg sa essere formale e spiazzante nello stesso tempo. Un vero tocco di eleganza anticonformista che quando si illumina si schiude, mostrando tutta la raffinatezza del vetro soffiato satinato. Un design naturale, essenziale, ma assolutamente non convenzionale, dedicato all'arredamento moderno.

Dans sa simplicité, la lampe Egg sait être à la fois formelle et étonnante. Une véritable touche d'élégance anticonformiste qui, lorsqu'elle s'allume, s'entrouvre pour dévoiler tout le raffinement du verre soufflé satiné. Un design naturel, essentiel, mais absolument non conventionnel, dédié à la décoration moderne.

The lamp Egg can be at the same time formal and unexpected, thanks to its simplicity. A real touch of nonconformist elegance which blossoms, showing the extreme refinement of blown glass when the light is on. A natural, essential, but unconventional design, dedicated to modern decor.

En su simplicidad, la lámpara Egg sabe ser formal e inquietante al mismo tiempo. Un verdadero toque de elegancia inconformista que cuando se ilumina se abre mostrando toda la sofisticación del vidrio soplado. Un design natural, esencial, pero absolutamente no convencional, dedicado al mobiliario moderno.

In ihrer Einfachheit weiß die Lampe EGG auch formal und gleichzeitig beeindruckend zu sein. Ein wirklich antikonformistischer Hauch von Eleganz, wenn sie erleuchtet ist und ihre ganze Eleganz des satinierten geblasenen Glases zeigt. Ein natürliches, essentielles Design das absolut nicht konventionell ist und der modernen Einrichtung gewidmet ist.

В своей простоте светильник Egg умеет быть формальным, но в то же время сбивающим с толку. Настоящий штрих анти-конформистской элегантности, которая проявляется во включенном состоянии, демонстрируя утонченность сатинового дутого стекла. Естественный, но абсолютно необычный дизайн предназначен для современных интерьеров.

**Struttura:** metallo cromato.  
**Diffusore:** vetro soffiato bianco latte satinato.

**Frame:** chrome-metal.  
**Diffuser:** milkwhite blown glass in satin finish.

**Struktur:** Metall verchromt.  
**Diffusor:** Satiniertes, milchweißes geblasenes Glas.

**Structure:** métal chromé.  
**Diffuseur:** verre soufflé blanc lait satiné.

**Estructura:** metal cromado.  
**Difusor:** vidrio soplado blanco leche satinado.

**Структура:** хромированный металл.  
**Рассеиватель:** молочно-белое сатиновое дутое стекло.

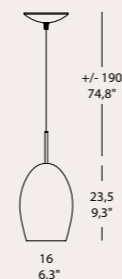

**EGG/S01**  
1 x MAX 70W E27 alo. ENERGY SAVER  
o/or  
1 x Max 8W E27 LED   
CE F IP 20 1 EAC

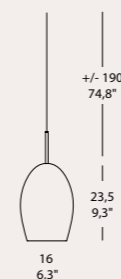

**EGG/S02**  
1 x MAX 70W E27 alo. ENERGY SAVER  
o/or  
1 x Max 8W E27 LED   
CE F IP 20 1 EAC

**SYSTEM 100 A**

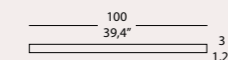

**SYSTEM 150 A**

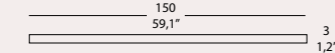

CE F IP 20

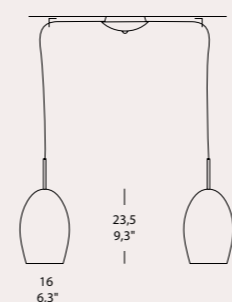

**EGG/S02**  
2 x MAX 70W E27 alo. ENERGY SAVER  
o/or  
2 x Max 8W E27 LED   
CE F IP 20 1 EAC

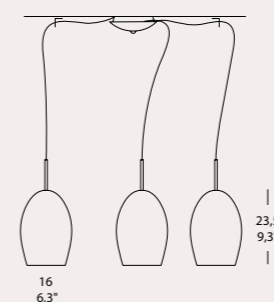

**EGG/S03**  
3 x MAX 70W E27 alo. ENERGY SAVER  
o/or  
3 x Max 8W E27 LED   
CE F IP 20 1 EAC

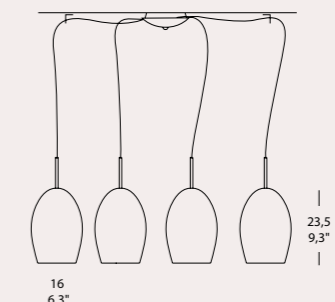

**EGG/S04**  
4 x MAX 70W E27 alo. ENERGY SAVER  
o/or  
4 x Max 8W E27 LED   
CE F IP 20 1 EAC

# SUNRISE ECO

design\_Ufficio Stile

Scoprire orizzonti luminosi.

Discovering radiant horizons.



Sunrise eco\_PA 390 LED



Sunrise eco\_PA 50 G9



Sunrise eco\_PA 270 LED



Sunrise eco\_PA 510 LED

# SUNRISE ECO

## \_technical data

Una lampada dal design essenziale, minimale, discreto come il primo sole che sorge all'orizzonte. Frutto di un restyling che ne ha ulteriormente raffinato l'aspetto, mettendo in luce nello stesso tempo tutta la sapienza tecnica di Morosini, oltre che la sua attenzione per l'ambiente.

Sunrise Eco è infatti disponibile anche a LED.  
Una soluzione brillante, quanto ecocompatibile.

A lamp with an essential, minimalist and moderate design as the first sunrise on the horizon. It is the result of a restyling that has further improved the look of the lamp, highlighting at the same time all the Morosini know how, as well as the attention to the environment.

Sunrise Eco is also available in LED.  
A solution as brilliant as eco-friendly.

Eine Lampe mit einem essentiellen, minimalen Design, diskret wie der erste Sonnenstrahl am Horizont. Ergebnis eines Restylings das seinen Aspekt noch verfeinert hat und gleichzeitig das ganze technische Wissen und auch das Umweltbewusstsein von Morosini ans Licht gebracht hat.

Sunrise Eco ist auch in der LED-Ausführung erhältlich.  
Eine brillante und umweltbewusste Lösung.

Une lampe design et essentielle, minimale, discret comme le soleil qui se lève à l'horizon. Fruit d'un restyling qui en a ultérieurement raffiné l'aspect, en dévoilant en même temps tout le savoir technique de Morosini, ainsi que l'attention qu'elle porte à l'environnement.

Sunrise Eco est en effet également disponible dans la version à LED. Une solution brillante et écologique.

Una lámpara de design esencial, minimal, discreto como el primer sol que surge en el horizonte. Fruto de un restyling que ha refinado ulteriormente el aspecto, poniendo en luz al mismo tiempo toda la sabiduría técnica de Morosini, además que su atención al ambiente.

Sunrise Eco está en efecto disponible también en versión LED. Una solución brillante y ecocompatible.

Светильник сдержанного дизайна, простого и минималистического, как первые лучи солнца, поднимающегося над горизонтом. Результат модернизации, полностью изменивший его внешний вид, показав, наряду с бережным отношением к внешней среде, все технические знания Morosini.

Модель Sunrise Eco доступна также в версии LED. Это превосходное, эко-совместимое решение.

**Struttura:** acciaio inox satinato o bianco opaco o nero opaco.  
**Diffusore:** vetro satinato.

**Frame:** satin finish stainless steel or matt white or matt black.  
**Diffuser:** satin glass

**Struktur:** Satiniertes Edelstahl, oder mattweiß, oder mattschwarz.  
**Diffusor:** Satiniertes Glas.

**Structure:** acier inox satiné ou blanc mat ou noir mat.  
**Diffuseur:** verre satiné.

**Estructura:** acero inox satinado o blanco opaco o negro opaco.  
**Difusor:** vidrio satinado.

**Структура:** нержавеющая сталь сатинированная или с белой матовой или черной матовой отделками.  
**Рассеиватель:** Сатинированное стекло.

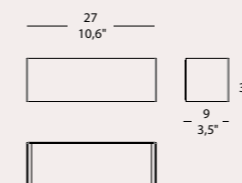

### SUNRISE ECO PA270 LED

8W 1280Lm 3000K  
Cri>80 220/240Vac 50-60Hz **LED**  
CE F IP 40 ADA 3

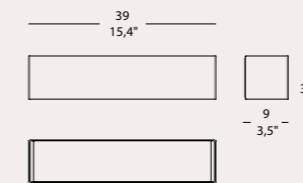

### SUNRISE ECO PA390 LED

16W 2560Lm 3000K  
Cri>80 220/240Vac 50-60Hz **LED**  
CE F IP 40 ADA 3

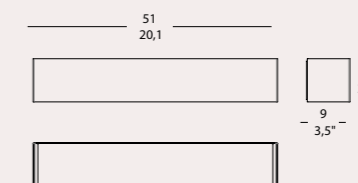

### SUNRISE ECO PA510 LED

24W 3840Lm 3000K  
Cri>80 220/240Vac 50-60Hz **LED**  
CE F IP 40 ADA 3

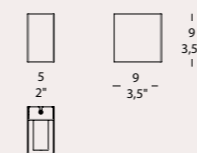

### SUNRISE ECO PA50 G9

1 x MAX 42/53W G9 alo. ENERGY SAVER  
o/or  
1 x MAX 3,5W G9 **LED**  
CE F IP 20 ADA 1

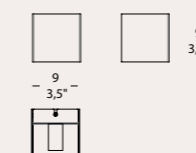

### SUNRISE ECO PA90 G9

1 x MAX 42/53W G9 alo. ENERGY SAVER  
o/or  
1 x MAX 3,5W G9 **LED**  
CE F IP 20 ADA 1

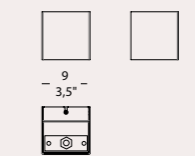

### SUNRISE ECO PA90 LED

8,8W 1326Lm 3000K **LED**  
Cri>80 220/240Vac 50-60Hz **LED**  
8,8W 1272Lm 2700K **LED**  
Cri>80 220/240Vac 50-60Hz **LED**  
CE F IP 20 ADA 3

# L'ELEGANZA AMA VIVERE CON STILE

---

Elegance  
loves living with style

Interpretare le esigenze di novità ed esclusività del mercato contemporaneo, reinterpretando lo stile classico. È la firma stilista di **Evi Style**, frutto di una sapienza artigianale tipicamente italiana, capace di trasmettere, con la luce e la materia, assoluta freschezza e raffinatezza. Selezionando e abbinando tessuti, cristalli, vetri, metalli, progresso e tradizione, rigore tecnico ed estro creativo, i designer di **Evi Style** creano atmosfere multisensoriali, proponendo articoli d'illuminazione formalmente e tecnicamente innovativi, pur rimanendo fedeli all'estetica dell'arredamento classico. Si tratta spesso di pezzi unici, in grado di diffondere in ogni ambiente, e in un solo istante, l'unicità di chi li ha creati e di chi li possiede.

---

The ability to interpret the requirements of innovation and exclusivity of the contemporary market, reinterpreting the classic style. It is the **Evi Style** designer signature, the result of a typically Italian craftsmanship, capable of transmitting, with light and material, absolute freshness and refinement. Selecting and combining different fabrics, crystals, glasses, metals, progress and tradition, technical rigor and creativity, the **Evi Style** designers create multisensory atmospheres, proposing formally and technically innovative lighting items, though remaining faithful to the aesthetics of classic decor. These are often unique pieces, able to carry in an instant, to every environment, the uniqueness of who have created them and who owns them.

*Evi Style*<sup>®</sup>  
Passion for light





# TROTTOLA

design\_Stefano Mandruzzato

Un girotondo di luce  
che evoca un gioco  
custodito nella memoria.

A circle of light that evokes  
a toy preserved  
in the memory.



Trottola\_SO Medium



Trottola\_SO Small



Trottola\_SO Big



Trottola\_SO 7 esempio di composizione/example of composition



# TROTTOLA

## technical data

Ispirata per nome e forma al secolare gioco per bambini, Trottola è una collezione di sospensioni in vetro soffiato composta da tre elementi dalla forte personalità.

Ironica, evocativa, giocosa, Trottola ci porta alla riscoperta della nostra infanzia. Disponibile in diverse soluzioni a sospensione, si presta sia per l'utilizzo domestico che per contract. La componente modulare permette innumerevoli combinazioni di customizzazione per soddisfare ogni esigenza del cliente. L'intera collezione utilizza sorgenti led dimmerabili.

Son nom et sa forme s'inspirent du jeu enfantin séculaire: Trottola est une collection de suspensions en verre soufflé constituée par trois éléments de caractère.

Ironique, évocatrice, gaie, Trottola nous mène à la découverte de notre enfance. Les différents modèles à suspension sont parfaits pour l'usage domestique et les collectivités. La composante modulaire permet d'innombrables combinaisons de personnalisation pour satisfaire toute exigence du client. Toute la collection utilise des sources led dimmables.

Inspired by the age-old game for children both in the name and shape, Trottola is a collection of three different blown glass suspensions with a strong personality.

Ironical, evocative, playful, Trottola brings us to the rediscovery of our childhood. Available in different suspension solutions, it is suitable both for private use and contract. The modular component allows countless combinations of customization to meet all customers' needs. The entire collection uses dimmable LED sources.

Trottola, cuyo nombre y forma se inspiran al antiguo juguete de la peonza, es una colección de colgantes de vidrio soplado que se compone por tres elementos con una personalidad fuerte.

Irónica, evocadora, jocosa, Trottola nos lleva a redescubrir nuestra infancia. Es disponible en diferentes opciones de colgante y se presta tanto al uso doméstico como al contract. El componente modular permite múltiples combinaciones para satisfacer la necesidad de customización de cada cliente. Toda la colección emplea fuentes led regulables.

Trottola hat sich von Namen und Form dieses Spiels inspirieren lassen.

Trottola ist eine aus geblasenem Glas angefertigte Pendelleuchtenfamilie, die aus drei Elementen mit einer hohen Individualität besteht.

Ironisch, Erinnerungen wachrufend, verspielt... Trottola bringt uns in die eigene Kindheit zurück. Sie ist in verschiedenen Ausführungen erhältlich, für das Haus wie für Objekte geeignet. Der modulare Bestandteil ermöglicht zahlreiche Kombinationen, um jeder Anforderung des Kunden gerecht zu werden. Die ganze Kollektion nutzt dimmbare Led-Lichtquellen.

Образ светильника и его название (Trottola - волчок, в переводе с итальянского), навеян старой детской игрушкой. Trottola - коллекция из трех подвесных светильников разных форм, выполненных из выдувного стекла.

Ироничный, игривый, навивающий воспоминания, Trottola возвращает нас в детство. Доступный в разных решениях, светильник подойдет как для частного интерьера, так и для общественного. Модульность системы позволяет создавать бесчисленное количество комбинаций и кастомизаций, чтобы удовлетворить все потребности клиента. Вся коллекция оснащена диммируемыми светодиодами.

**Struttura:** rosone bianco - altre parti in metallo nelle colorazioni: nero opaco, oro opaco.

**Frame:** white canopy - other metal parts in the colors: matt black, matt gold.

**Struktur:** Baldachin Weiß - die anderen Teile aus Metall in den Farben: Mattschwarz, Mattgold.

**Structure:** rosette blanche - autres parties en métal dans les teintes : noir mat, or mat.

**Estructura:** rosetón blanco; otras partes de metal en los siguientes colores: negro mate, oro mate.

**Структура:** белый розон, остальные металлические части - матовый чёрный либо матовое золото.

**Diffusore:** vetro soffiato nelle colorazioni: trasparente, ambr, fumè.

**Diffuser:** blown glass in the following colors: transparent, amber, smoke-grey.

**Diffusor:** geblasenes Glas in den Farben: Transparent, Bernstein, Rauchgrau.

**Diffuseur:** verre soufflé dans les teintes : transparent, ambr, fumé.

**Difusor:** vidrio soplado en los colores: transparente, ámbar, gris ahumado.

**Рассеиватель:** Выдувное стекло в цветах: прозрачный, янтарь, дымчатый.



**CT:** Trasparente/Transparent

**AM:** Ambr/Amber

**FU:** Fumè

### SOSPENSIONI (CAVO STANDARD CM 250)/PENDANT LAMPS (STANDARD CABLE CM 250)

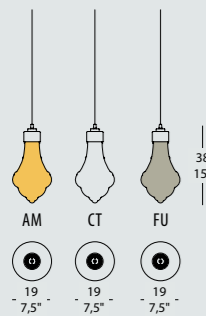

#### TROTTOLA SO SMALL

10W 1.400 Lm 2700K Cri>80 300 mA LED

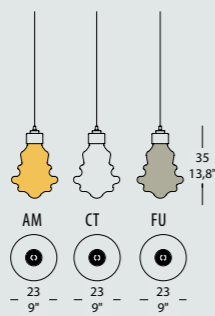
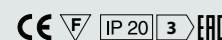

#### TROTTOLA SO MEDIUM

10W 1.400 Lm 2700K Cri>80 300 mA LED

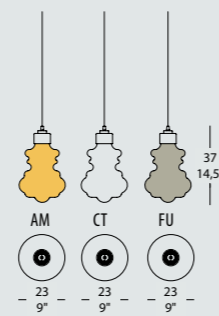
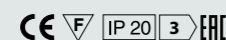

#### TROTTOLA SO BIG

10W 1.400 Lm 2700K Cri>80 300 mA LED

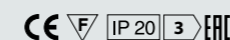

### ROSONI/CANOPIES

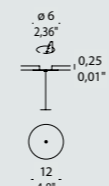

#### TROTTOLA IN-1

ROSONE A INCASSO A 1 LUCE CON DRIVER 220/240Vac 50-60 Hz  
1-LIGHT RECESSED CANOPY WITH DRIVER 220/240Vac 50-60 Hz

#### TROTTOLA IN-1 DIM PD

ROSONE A INCASSO A 1 LUCE CON DRIVER DIMMERABILE PUSH 220/240Vac 50-60 HZ  
1-LIGHT RECESSED CANOPY WITH PUSH DIMMABLE DRIVER 220/240Vac 50-60 HZ

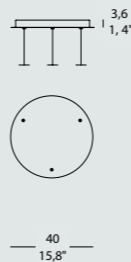

#### TROTTOLA R03

ROSONE A 3 LUCI CON DRIVER 220/240Vac 50-60 Hz  
3-LIGHT CANOPY WITH DRIVER 220/240Vac 50-60 Hz

#### TROTTOLA R03 DIM PD

ROSONE A 3 LUCI CON DRIVER DIMMERABILE PUSH 220/240Vac 50-60 HZ  
3-LIGHT CANOPY WITH PUSH DIMMABLE DRIVER 220/240Vac 50-60 HZ

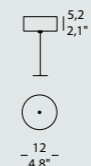

#### TROTTOLA R01

ROSONE A 1 LUCE CON DRIVER 220/240Vac 50-60 Hz  
1-LIGHT CANOPY WITH DRIVER 220/240Vac 50-60 Hz

#### TROTTOLA R01 DIM PD

ROSONE A 1 LUCE CON DRIVER DIMMERABILE PUSH 220/240Vac 50-60 HZ  
1-LIGHT CANOPY WITH PUSH DIMMABLE DRIVER 220/240Vac 50-60 HZ

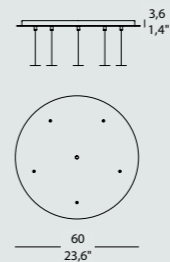

#### TROTTOLA R05

ROSONE A 5 LUCI CON DRIVER 220/240Vac 50-60 Hz  
5-LIGHT CANOPY WITH DRIVER 220/240Vac 50-60 Hz

#### TROTTOLA R05 DIM PD

ROSONE A 5 LUCI CON DRIVER DIMMERABILE PUSH 220/240Vac 50-60 HZ  
5-LIGHT CANOPY WITH PUSH DIMMABLE DRIVER 220/240Vac 50-60 HZ

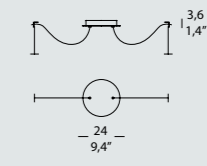

#### TROTTOLA R02

ROSONE A 2 LUCI CON DRIVER 220/240Vac 50-60 Hz  
2-LIGHT CANOPY WITH DRIVER 220/240Vac 50-60 Hz

#### TROTTOLA R02 DIM PD

ROSONE A 2 LUCI CON DRIVER DIMMERABILE PUSH 220/240Vac 50-60 HZ  
2-LIGHT CANOPY WITH PUSH DIMMABLE DRIVER 220/240Vac 50-60 HZ

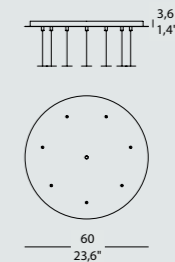

#### TROTTOLA R07

ROSONE A 7 LUCI CON DRIVER 220/240Vac 50-60 Hz  
7-LIGHT CANOPY WITH DRIVER 220/240Vac 50-60 Hz

#### TROTTOLA R07 DIM PD

ROSONE A 7 LUCI CON DRIVER DIMMERABILE PUSH 220/240Vac 50-60 HZ  
7-LIGHT CANOPY WITH PUSH DIMMABLE DRIVER 220/240Vac 50-60 HZ



SU RICHIESTA È POSSIBILE AVERE ANCHE DRIVER DIMMERABILE 1/10V  
1/10V DIMMABLE DRIVER CAN BE SUPPLIED BY REQUEST

### ESEMPI DI COMPOSIZIONE/EXAMPLES OF COMPOSITION

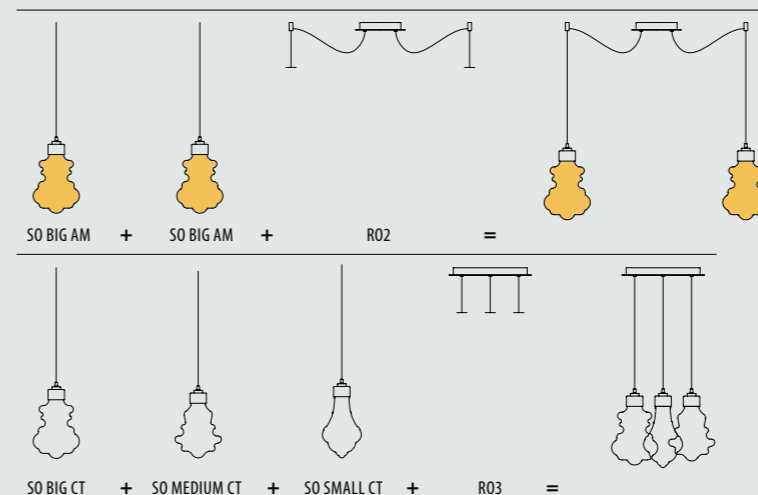



# BIA

design\_ Borri Manuel  
Diagora Design

La riscoperta del  
passato che illumina  
il presente.

The rediscovery of  
the past that enlightens  
the present.



Bia\_CORINTO SMALL, ATENE SMALL, ARGO SMALL + RO1



Bia\_ATENE BIG + RO2



Bia\_CORINTO SMALL + RO6

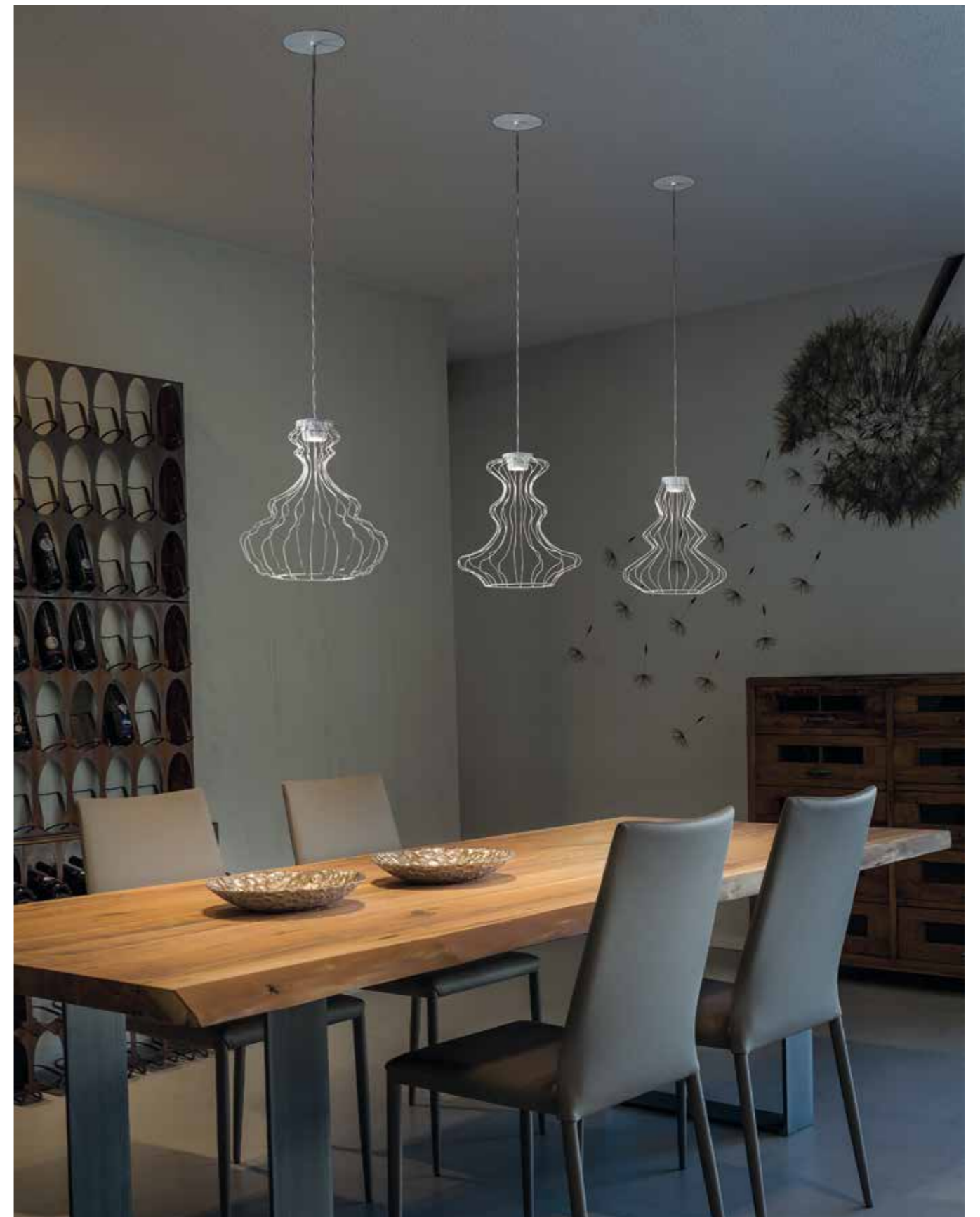

Bia\_CORINTO SMALL, ATENE SMALL, ARGO SMALL + IN1





Bia\_ esempio di composizione con RO12 / example of composition with RO12

# BIA

## \_technical data

Bia conduce ai giorni nostri i fasti dell'immortale cultura ellenica. Concepito come elemento di illuminazione decorativa contemporanea, affonda le sue radici nelle sinuose forme degli antichi vasi greci, icone di una civiltà che dal passato sino ad oggi ha rappresentato un faro per l'umanità. Bia viene realizzata in due misure, tre disegni e quattro differenti finiture. In ogni sua declinazione rispetta le parti che componevano i vasi ellenici, dall'orlo al piede, per offrire un'esperienza sensoriale caratterizzata da un gusto e una raffinatezza senza tempo.

Bia leads the glories of the immortal Hellenic culture to the present day. Conceived as an element of contemporary decorative lighting, it traces its roots back to the sinuous shapes of the ancient Greek vases, symbols of a civilization that has been a lighthouse for humanity from the past to this day. Bia is available in two sizes, three styles and four different finishes. In all versions it complies with the parts from which the Greek vases were made. From the lip to the foot, it offers a sensory experience characterised by timeless taste and refinement.

Bia führt den Ruhm der unsterblichen griechischen Kultur in die heutige Zeit. Als ein Element der zeitgenössischen dekorativen Beleuchtung konzipiert, hat Bia seine Wurzeln in den gewundenen Formen der antiken griechischen Vasen, Symbolen einer Zivilisation, die ein Leuchtturm für die Menschheit von der Vergangenheit bis zur Gegenwart ist. Bia ist in zwei Größen, drei Formen und vier verschiedenen Oberflächen erhältlich. In allen Versionen folgt Bia genau allen Teilen der griechischen Vasen, von dem Rand bis zum Fuß, um ein sinnliches Erlebnis zu bieten, das durch zeitlosen Geschmack und Raffinesse gekennzeichnet ist.

Виа относит нас к бессмертной греческой культуре. Задуманный как элемент современного декоративного освещения, он берёт своё начало от форм древнегреческих ваз, символов цивилизации, которая и по сей день остаётся маяком для человечества. Виа выпускается в двух размерах, трёх стилях и четырёх различных отделках. Во всех версиях он соответствует элементам, из которых изготовлены греческие вазы.

Bia mène à nos jours les fastes de l'immortelle culture hellénique. Conçue comme élément d'éclairage décoratif contemporain, elle plonge ses racines dans les formes sinueuses des anciens vases grecs, icônes d'une civilisation qui a été un phare pour l'humanité du passé à nos jours. Bia se réalise en deux mesures, trois dessins et quatre finitions différentes. Dans chacune des déclinaison, elle respecte les parties qui composent les vases helléniques, de la lèvre au fond, pour offrir une expérience sensorielle qui est caractérisée par un goût et un raffinement intemporel.

Bia trae a nuestros días los fastos de la inmortal cultura helénica. Concebida como elemento de iluminación decorativa contemporáneo, hunde sus raíces en las formas sinuosas de las antiguas vasijas griegas, iconos de una civilización que ha representado un faro para la humanidad, del pasado hasta hoy. Bia se realiza en dos medidas, tres diseños y cuatro acabados diferentes. En cada su declinación respeta las partes que formaban las vasijas helénicas, del borde a la basa, para ofrecer una experiencia sensorial caracterizada por un gusto y una exquisitez sin tiempo.

**Struttura:** rosone bianco – altre parti in metallo nelle colorazioni: bianco opaco, nero opaco, oro opaco, rame opaco.

**Frame:** white canopy - other metal parts in the colors: matt white, matt black, matt gold, matt copper.

**Struktur:** Baldachin: weiß – die anderen Metallteile in den Farben: Mattweiß, Mattschwarz, Mattgold, Mattkupfer.

**Structure:** rosette blanche – autres parties métalliques dans les couleurs: blanc mat, noir mat, or mat, cuivre mat.

**Estructura:** florón blanco – otras partes de metal en los colores: blanco mate, negro mate, oro mate, cobre mate.

**Структура:** белый розон, остальные металлические части - матовый чёрный либо матовое золото.

**Diffusore:** Policarbonato satinato

**Diffuser:** Polycarbonate satin finish.

**Diffusor:** Satin Polycarbonat

**Diffusor:** Polycarbonate satiné.

**Difusor:** Policarbonato satinado.

**Рассеиватель:** Матовый поликарбонат

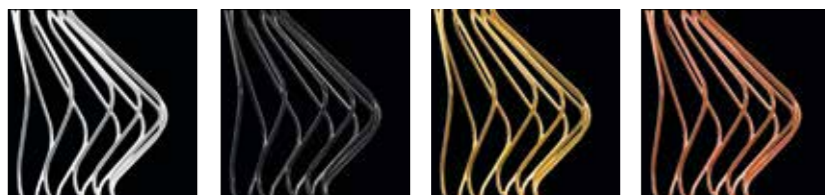

06: Bianco / White

07: Nero / Black

22: Oro / Gold

29: Rame / Copper

### SOSPENSIONI (CAVO STANDARD CM 350 + DECENTRAMENTO)/PENDANT LAMPS (STANDARD CABLE CM 350 + OFF CENTRE POSITION)

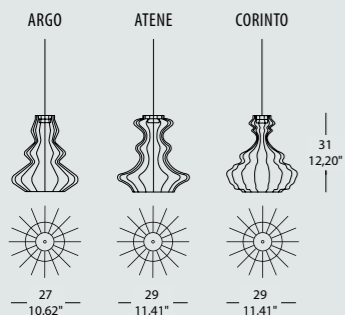

**BIA SO S/R SMALL**

8W 632lm 2700K Cri>80 230 Vac 50-60hz LED

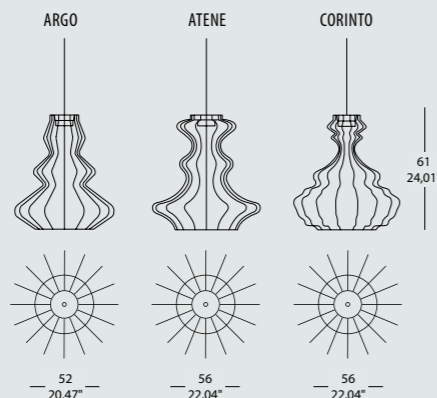
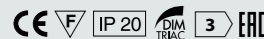

**BIA SO S/R BIG**

12W 1020lm 2700K Cri>80 230 Vac 50-60hz LED

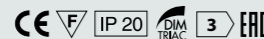

### ROSONI/CANOPIES

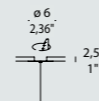

**BIA IN-1**

ROSONE A INCASSO A 1 LUCE  
1-LIGHT RECESSED CANOPY



**BIA RO-1**

ROSONE A 1 LUCE  
1-LIGHT CANOPY

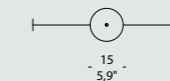

**BIA RO-2**

ROSONE A 2 LUCI  
2-LIGHT CANOPY

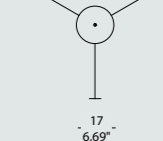
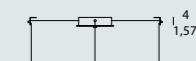

**RAMETTO RO-3**

ROSONE A 3 LUCI  
3-LIGHT CANOPY

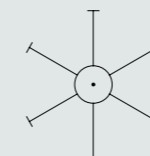
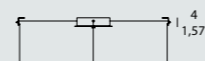

**BIA RO-6**

ROSONE A 6 LUCI  
6-LIGHT CANOPY

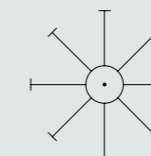
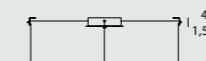

**BIA RO-8**

ROSONE A 8 LUCI  
8-LIGHT CANOPY

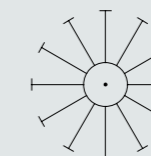
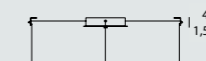

**BIA RO-12**

ROSONE A 12 LUCI  
12-LIGHT CANOPY



### ESEMPI DI COMPOSIZIONE/EXAMPLES OF COMPOSITION

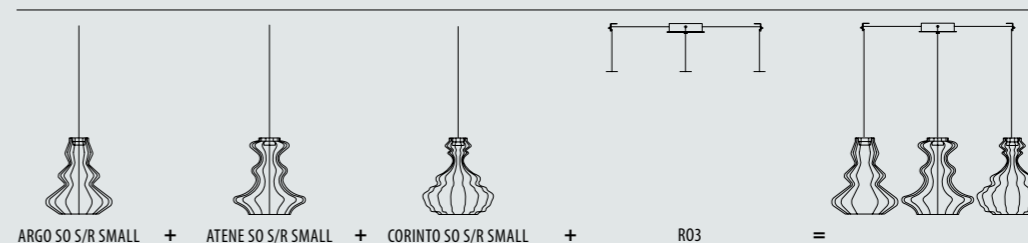
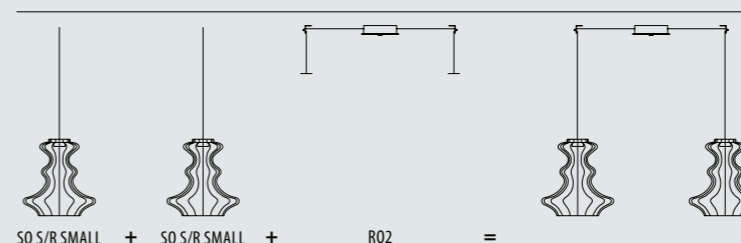



# MINERVA

design\_ Chiaramonte Marin

Accendi il mio fuoco.

Light my fire.



Minerva\_SS + RO2



Minerva\_SS + RO3



Minerva\_SF + IN1

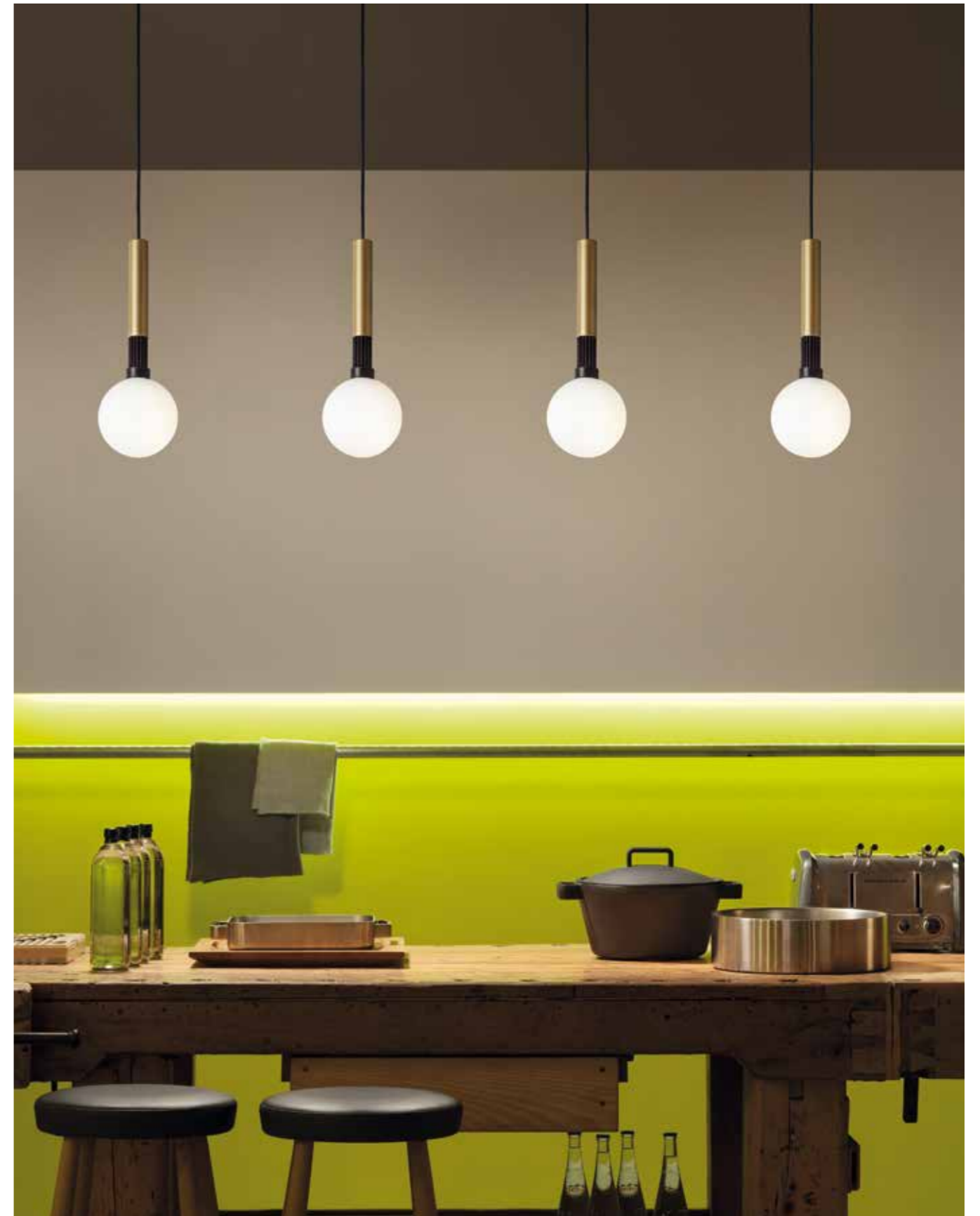

Minerva\_SF + IN1



Minerva\_SC + RO7



Minerva\_SC + RO5



Minerva\_SC + RO1

## MINERVA

\_technical data

Un nome che riporta al passato, agli indimenticabili fiammiferi Minerva, prodotti che per decenni hanno caratterizzato la quotidianità di milioni di Italiani. Proprio da questa semplice fonte di fuoco e luce prende vita una sospensione che si caratterizza per il posizionamento del dissipatore di calore, pensato per rappresentare il punto focale dell'intera struttura. I diffusori sono in vetro soffiato, dai colori molto tenui e tramati con lavorazioni tipiche del vetro di Murano.

C'est un nombre qui rappelle le passé, les allumettes italiennes Minerva. Produits qui ont caractérisés la vie quotidienne des milliers d'Italiens pendant des décennies. La suspension prend vie de cette simple source de feu et de lumière ; elle se caractérise par l'emplacement du diffuseur de chaleur, pensé pour représenter le point focal de l'entière structure. Les diffuseurs sont en verre soufflé, couleurs intensément douces et modelés avec le façonnage typique du verre de Murano.

A name that brings back the past, to the unforgettable Italian Minerva matches, products that have characterized the daily life of millions of Italians for decades. This suspension comes to life taking inspiration from this simple source of fire. It is characterised by the position of the heat sink, designed to represent the key point of the entire item. The diffusers are in blown glass, in very soft colors, created with the typical Murano glass processing techniques.

Es un nombre que lleva al pasado, a las cerillas italianas Minerva, que se produjeron durante décadas y que caracterizaron la cotidianidad de millones de italianos. Precisamente de esta simple fuente de fuego y luz, cobra vida una suspensión que se caracteriza por la colocación del dissipador de calor, pensado para representar el punto focal de toda la estructura. Los difusores son de vidrio soplado, de colores suaves y con tramas, que llevan las elaboraciones típicas del vidrio de Murano.

Ein Name, der Erinnerungen weckt. Die unvergesslichen italienischen Minerva Wachsstreichhölzer. Produkte, die seit Jahrzehnten das tägliche Leben von Millionen Italienern geprägt haben. Diese Pendelleuchte wird zum Leben erweckt und inspiriert von dieser einfachen Feuerquelle. Sie ist charakterisiert durch die Position des Kühlkörpers, um den Schlüsselpunkt des gesamten Gegenstandes darzustellen. Der Diffusor ist aus geblasenem Glas, in samtweichen Farben, mit den typischen Verarbeitungstechniken muranesischer Glasbläserkunst hergestellt.

Имя, которое относит нас в прошлое, к незабываемым итальянским спичкам Minerva, продукту характеризовавшему жизнь миллионов итальянцев, на протяжении десятилетий. Вдохновение на создание данного светильника, пришло от кого простого источника огня. Диффузоры из выдувного стекла в очень мягких цветах, выполнены с применением традиционных техник производства муранского стекла.

**Struttura:** rosone bianco, altre parti in metallo nelle colorazioni: nero opaco, oro opaco.

**Diffusore:** vetro soffiato SC e SS nelle colorazioni: bianco latte lucido, giallo topazio, fumè, cristallo e oro 24 Kt. Vetro soffiato SF: bianco latte satinato.

**Frame:** white canopy - other metal parts in the colors: matt black, matt gold.

**Diffuser:** blown glass SC and SS in the following colours: Glossy milk white, topaz yellow, smoke grey, crystal and gold 24 Kt. Blown glass SF: milk white satin finish.

**Struktur:** Baldachin: Weiß – Die anderen Metallteile in den Farben: Mattschwarz, Mattgold.

**Diffusor:** SC und SS geblasenes Glas in den Farben: glänzend Milchweiß, Gelbtapas, Fumè, Kristallglas und Gold 24 Kt - SF geblasenes Glas: Milchweiß satiniert.

**Structure:** rosette blanche – autres parties métalliques dans les couleurs: noir mat, or mat.

**Diffuseur:** verre soufflé SC et SS dans les couleurs: blanc lait brillant, jaune topaze, fumé, cristal et or 24 Kt. Verre soufflé SF: blanc lait satiné.

**Estructura:** florón blanco – otras partes de metal en los colores: negro mate, oro mate.

**Difusor:** vidrio soplado SC e SS en los colores: blanco leche brillante, amarillo topacio, gris ahumado, cristal y oro 24 Kt. Vidrio soplado SF: blanco leche satinado.

**Структура:** белый розон, остальные металлические части - матовый чёрный лилово-золотое.

**Рассеиватель:** Выдувное стекло SC и SS в следующих цветах: желтый топаз, дымчатый, хрусталь и Золото 24 карата. Выдувное стекло SF: Молочно-белое сатирированное стекло.



**BI:** Bianco latte lucido/  
Glossy milk white



**CO:** Cristallo e oro 24 Kt/  
Crystal and gold 24 Kt



**FE:** Fumè/  
Smoke grey



**TP:** Giallo topazio/  
Topaz yellow



**07:** Nero opaco/  
Matt black



**22:** Oro opaco/  
Matt gold



**BI:** Bianco latte lucido/  
Glossy milk white



**CO:** Cristallo e oro 24 Kt/  
Crystal and gold 24 Kt



**FE:** Fumè/  
Smoke grey



**TP:** Giallo topazio/  
Topaz yellow



**BS:** bianco latte satinato/  
Milk white satin finish



SOSPENSIONI (CAVO STANDARD CM 250)/PENDANT LAMPS (STANDARD CABLE CM 250)

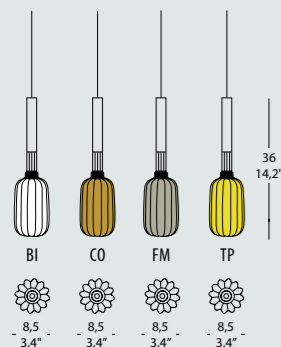

**MINERVA SC**  
6,1W 785 Lm 2700K Cri>80 24Vdc LED  
CE F IP 20 EAC

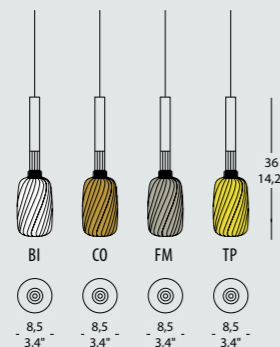

**MINERVA SS**  
6,1W 785 Lm 2700K Cri>80 24Vdc LED  
CE F IP 20 EAC

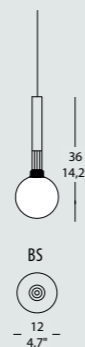

**MINERVA SF**  
6,1W 785 Lm 2700K Cri>80 24Vdc LED  
CE F IP 20 EAC

ESEMPI DI COMPOSIZIONE/EXAMPLES OF COMPOSITION

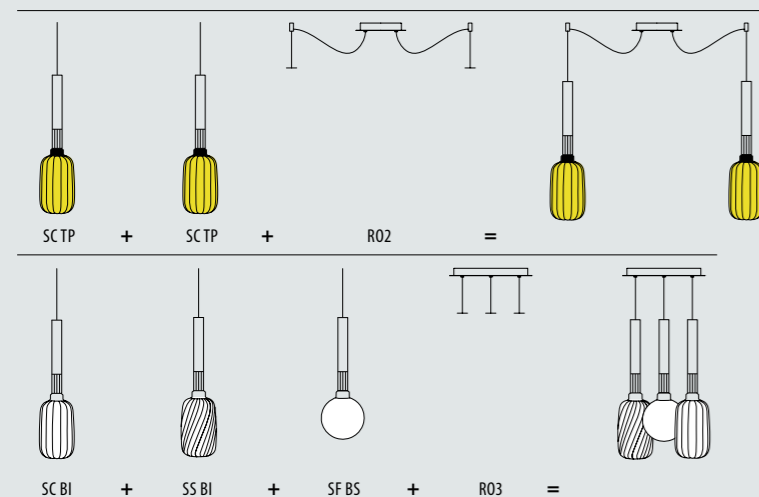

ROSONI/CANOPIES

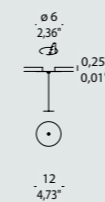

**MINERVA IN-1**  
ROSONE A INCASSO A 1 LUCE CON DRIVER 220/240Vac 50-60 Hz  
1-LIGHT RECESSED CANOPY WITH DRIVER 220/240Vac 50-60 Hz  
CE F IP 20 EAC

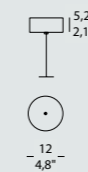

**MINERVA R01**  
ROSONE A 1 LUCE CON DRIVER 220/240Vac 50-60 Hz  
1-LIGHT CANOPY WITH DRIVER 220/240Vac 50-60 Hz  
CE F IP 20 EAC

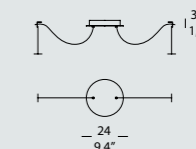

**MINERVA R02**  
ROSONE A 2 LUCI CON DRIVER 220/240Vac 50-60 Hz  
2-LIGHT CANOPY WITH DRIVER 220/240Vac 50-60 Hz  
CE F IP 20 EAC

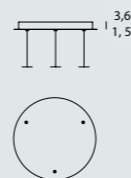

**MINERVA R03**  
ROSONE A 3 LUCI CON DRIVER 220/240Vac 50-60 Hz  
3-LIGHT CANOPY WITH DRIVER 220/240Vac 50-60 Hz

**MINERVA R03 DIM PD**  
ROSONE A 3 LUCI CON DRIVER DIMMERABILE PUSH  
220/240Vac 50-60 HZ  
3-LIGHT CANOPY WITH PUSH DIMMABLE DRIVER  
220/240Vac 50-60 HZ  
CE F IP 20 EAC

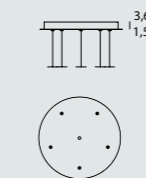

**MINERVA R05**  
ROSONE A 5 LUCI CON DRIVER 220/240Vac 50-60 Hz  
5-LIGHT CANOPY WITH DRIVER 220/240Vac 50-60 Hz

**MINERVA R05 DIM PD**  
ROSONE A 5 LUCI CON DRIVER DIMMERABILE PUSH  
220/240Vac 50-60 HZ  
5-LIGHT CANOPY WITH PUSH DIMMABLE DRIVER  
220/240Vac 50-60 HZ  
CE F IP 20 EAC

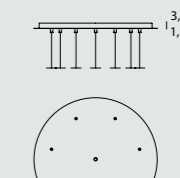

**MINERVA R07**  
ROSONE A 7 LUCI CON DRIVER 220/240Vac 50-60 Hz  
7-LIGHT CANOPY WITH DRIVER 220/240Vac 50-60 Hz

**MINERVA R07 DIM PD**  
ROSONE A 7 LUCI CON DRIVER DIMMERABILE PUSH  
220/240Vac 50-60 HZ  
7-LIGHT CANOPY WITH PUSH DIMMABLE DRIVER  
220/240Vac 50-60 HZ  
CE F IP 20 EAC



# MEMORIA

design\_ Dima Loginoff

Art Deco in chiave  
moderna e chic.

Art Deco on a modern  
and chic take.











Memoria\_ esempio di composizione con RO7 / example of composition with RO7



S1-A0 S1-A1 S1-A2 S1-A3 S1-A4 S1-A5 S1-A6



S2-A0 S2-A1 S2-A2 S2-A3 S2-A4 S2-A5 S2-A6



C1-A0 C1-A1 C1-A2 C1-A3 C1-A4 C1-A5 C1-A6



C2-A0 C2-A1 C2-A2 C2-A3 C2-A4 C2-A5 C2-A6

Dettagli/Details

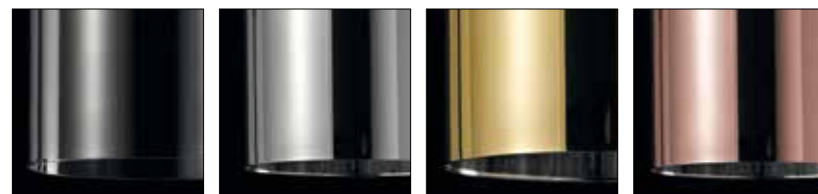

Trasparente/  
Transparent Cromo/  
Chrome Oro/  
Gold Rame/  
Copper

# MEMORIA

## \_technical data

Stile internazionale e ricercatezza italiana, per una collezione di lampade a sospensione che rimanda all'estetica dell'Art Déco, rivisitata in chiave più moderna e chic. Disponibile in versione singola o multipla, sia circolare che lineare, Memoria può acquisire ulteriore esclusività giocando con i volumi dei suoi elementi e le diverse tonalità dei diffusori in vetro: trasparenti o metallizzati in oro, cromo e rame, abbinati a cavi rivestiti in calza metallica dello stesso colore. L'effetto ottenuto con i diffusori metallizzati, definito "trans-mirror", esalta il fascino della lampada generando a luce accesa sofisticate trasparenze. La versione con diffusore trasparente invece, racchiude al suo interno una luminosa sfera in vetro soffiato, testimone della cura del dettaglio tipica del brand. Tutta la collezione utilizza sorgenti a LED.

Style international et raffinement italien, pour une collection de lampes à suspension qui renvoie à l'esthétique de l'Art Déco, revue sous un jour plus moderne et chic. Fournie dans la version simple ou multiple, circulaire et linéaire, Memoria peut devenir plus exclusive en jouant avec les volumes de ces éléments et les différentes tonalités des diffuseurs en verre: transparents ou métallisés en or, chrome et cuivre, associés à des câbles revêtus d'une gaine métallique de la même couleur. L'effet obtenu avec les diffuseurs métallisés, défini "trans-mirror", exalte le charme de la lampe en générant des transparences sophistiquées lorsqu'elle est allumée. En revanche, la version avec un diffuseur transparent, contient une sphère lumineuse en verre soufflé, témoignant du soin du détail typique de la marque. Toute la collection utilise des sources à LED.

With a reference to Art Decò, revisited in a more modern and chic key, this collection of pendant lamps is the representation of International style and Italian preciousness. Available in single and multiple, as well as in circular and linear versions, Memoria can gain additional exclusivity playing with the volumes of its elements and the different shades of glass diffusers: transparent or metalized in gold, chrome and copper, combined with cables of the same color, coated with metal braid. The "trans-mirror" effect, obtained with the metalized diffusers, enhances the charm of the lamp creating sophisticated transparencies when the light is on. The version with the transparent diffuser, instead, contains within it a bright ball in blown glass, a witness of the attention to detail, that is a typical element of the brand. The entire collection uses LED sources.

Estilo internacional y elegancia italiana para una colección de lámparas de suspensión que recuerda la estética del Art Déco revisitada en clave más moderna y chic. Disponible en versión única o múltiple, tanto circular como lineal, Memoria puede adquirir más exclusividad jugando con los volúmenes de sus elementos y los varios tonos de los difusores en vidrio: transparentes o metalizados en oro, cromo y cobre, combinados con cables forrados en trenza metálica del mismo color. El efecto obtenido con los difusores metalizados, definido "trans-mirror", exalta el encanto de la lámpara generando sofisticadas transparencias con la luz encendida. La versión con difusor transparente en cambio, encierra en su interior una luminosa esfera de vidrio soplado, testigo del cuidadoso detalle, típico de la marca. Toda la colección utiliza fuentes de LED.

Internationaler Stil und italienische Raffinesse für eine Lampenkollektion mit Abhängung, die sich an die Ästhetik des Art Deco in moderner und eleganter Form anlehnt. Sie ist erhältlich in einfacher oder mehrfacher Version, sowohl kreisförmig als auch linear. Memoria gewinnt zusätzliche Exklusivität durch das Spiel mit dem Volumen seiner Elemente und den unterschiedlichen Tonalitäten (transparent oder metallisiert in Gold, verchromt und Kupfer) der Glas-Lampenschirme im Einklang mit den umkleideten Kabeln in der gleichen Farbe. Der sogenannte "Spiegel-Effekt" der durch die metallisierten Diffusoren erzielt wird, erhöht den Charme der Lampe die bei eingeschaltetem Licht anspruchsvolle Transparenz erzeugt. Die Ausführung mit transparentem Diffusor hingegen, umschließt im Inneren eine helle Kugel in geblasenem Glas. Der Beweis für die Liebe zum Detail, typisch für unsere Marke. Die ganze Kollektion ist exklusiv mit LED-Lichtquellen ausgestattet.

Интернациональный стиль и итальянская изысканность, для роскошной коллекции подвесных светильников, которая возвращает к эстетике стиля ар-деко, переосмысленной в современном ключе. Предоставлена в виде одиночного светильника или группы светильников, как с линейным, так и с круговым расположением, Memoria может приобрести дополнительную исключительность, играя с объемами своих элементов и разными оттенками своих рассеивателей из стекла: прозрачных или металлизированных, доступных в следующих цветах: золото, хром и медь; с проводами, в металлической оплетке такого же цвета. Эффект, полученный с применением металлизированных рассеивателей, названный "trans-mirror", подчеркивает обаяние светильника, создавая во включенном состоянии изысканную прозрачность. Версия с прозрачным рассеивателем, напротив, заключает внутри себя светящуюся сферу из дутого стекла - свидетеля заботы о деталях, типичной для бренда. Во всей коллекции в качестве источника света используется LED.

**Struttura:** metallo bianco opaco, con particolari in cromo, oro e rame.  
**Diffusore:** vetro trasparente, cromo, oro e rame, in diverse combinazioni.

**Frame:** matt white metal, with details in chrome, gold and copper.  
**Diffuser:** glass in transparent, chrome, gold and copper, in various combinations.

**Struktur:** metall mattweiß, Details in Chrom, Gold und Kupfer.  
**Difusor:** Glas transparent, Chrom, Gold und Kupfer, verschiedene Kombinationen möglich.

**Struttura:** metallo bianco opaco, con particolari in cromo, oro e rame.  
**Diffusore:** vetro trasparente, cromo, oro e rame, in diverse combinazioni.

**Structure:** métal blanc opaque, avec des détails en chrome, or et cuivre.  
**Diffuseur:** verre transparent, chrome, or et cuivre, dans différentes combinaisons.

**Estructura:** metal blanco opaco, con detalles de cromo, oro y cobre.  
**Difusor:** vidrio transparente, cromo oro y cobre, en varias combinaciones.

**Структура:** белый матовый металл с деталями, выполненными в следующих расцветках: хром, золото и медь.  
**Рассеиватель:** возможные расцветки: прозрачный, хром, золото и медь, в различных сочетаниях.



SOSPENSIONI (CAVO STANDARD CM 200)/PENDANT LAMPS (STANDARD CABLE CM 200)

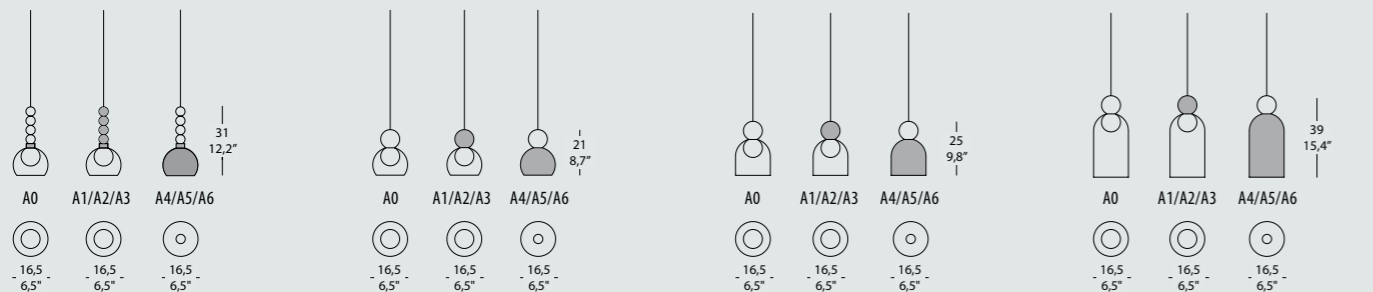

**MEMORIA S1**  
4,7W 480 Lm 3000K Cri>80 500 mA LED  
CE F IP20 3 EAC

**MEMORIA S2**  
4,7W 480 Lm 3000K Cri>80 500 mA LED  
CE F IP20 3 EAC

**MEMORIA C1**  
4,7W 480 Lm 3000K Cri>80 500 mA LED  
CE F IP20 3 EAC

**MEMORIA C2**  
4,7W 480 Lm 3000K Cri>80 500 mA LED  
CE F IP20 3 EAC

ESEMPI DI COMPOSIZIONE/EXAMPLES OF COMPOSITION

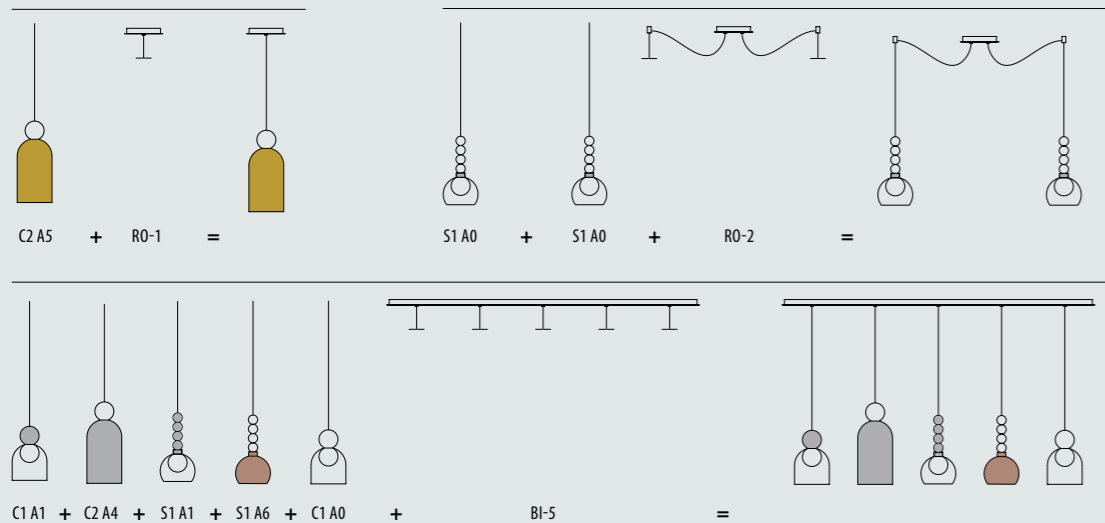

ROSONI/CANOPIES

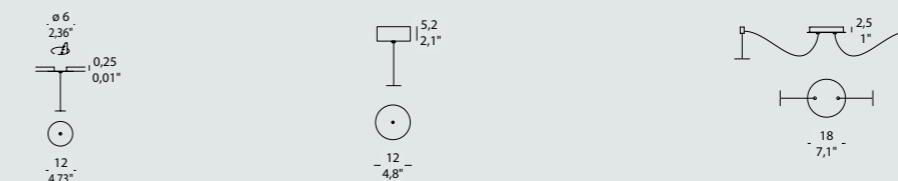

**MEMORIA IN-1**  
ROSONE A INCASSO A 1 LUCE  
CON DRIVER 220/240  
1-LIGHT RECESSED CANOPY  
WITH DRIVER 220/240  
CE F IP20 EAC

**MEMORIA RO-1**  
ROSONE A 1 LUCE CON DRIVER 220/240V  
1-LIGHT CANOPY WITH DRIVER 220/240V  
CE F IP20 EAC

**MEMORIA RO-2**  
ROSONE A 2 LUCI CON DRIVER 220/240V  
2-LIGHT CANOPY WITH DRIVER 220/240V  
CE F IP20 EAC

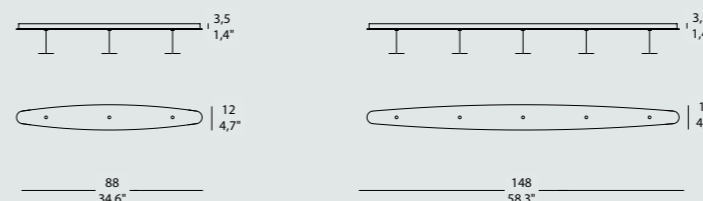

**MEMORIA BI-3**  
BINARIO A 3 LUCI CON DRIVER 220/240V  
3-LIGHT TRACK WITH DRIVER 220/240V  
CE F IP20 EAC

**MEMORIA BI-5**  
BINARIO A 5 LUCI CON DRIVER 220/240V  
5-LIGHT TRACK WITH DRIVER 220/240V  
CE F IP20 EAC

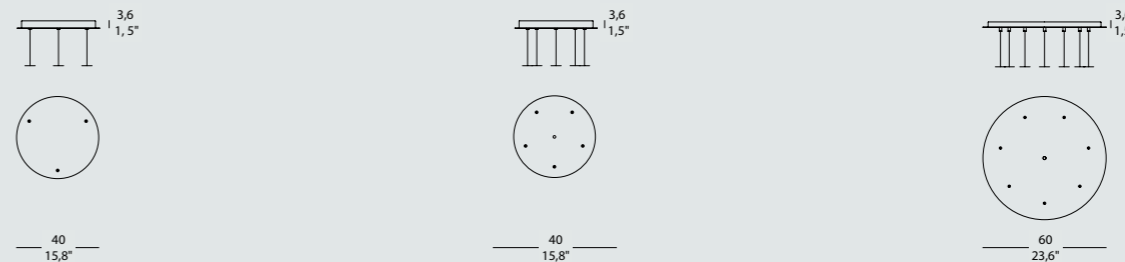

**MEMORIA R03 C**  
ROSONE A 3 LUCI CON DRIVER 220/240Vac 50-60 Hz  
3-LIGHT CANOPY WITH DRIVER 220/240Vac 50-60 Hz

**MEMORIA R03 C DIM PD**  
ROSONE A 3 LUCI CON DRIVER DIMMERABILE PUSH  
220/240Vac 50-60 HZ  
3-LIGHT CANOPY WITH PUSH DIMMABLE DRIVER  
220/240Vac 50-60 HZ  
CE F IP20 EAC

**MEMORIA R05**  
ROSONE A 5 LUCI CON DRIVER 220/240Vac 50-60 Hz  
5-LIGHT CANOPY WITH DRIVER 220/240Vac 50-60 Hz

**MEMORIA R05 DIM PD**  
ROSONE A 5 LUCI CON DRIVER DIMMERABILE PUSH  
220/240Vac 50-60 HZ  
5-LIGHT CANOPY WITH PUSH DIMMABLE DRIVER  
220/240Vac 50-60 HZ  
CE F IP20 EAC

**MEMORIA R07**  
ROSONE A 7 LUCI CON DRIVER 220/240Vac 50-60 Hz  
7-LIGHT CANOPY WITH DRIVER 220/240Vac 50-60 Hz

**MEMORIA R07 DIM PD**  
ROSONE A 7 LUCI CON DRIVER DIMMERABILE PUSH  
220/240Vac 50-60 HZ  
7-LIGHT CANOPY WITH PUSH DIMMABLE DRIVER  
220/240Vac 50-60 HZ  
CE F IP20 EAC

SU RICHIESTA È POSSIBILE AVERE ANCHE DRIVER DIMMERABILE 1/10V  
1/10V DIMMABLE DRIVER CAN BE SUPPLIED BY REQUEST



# VINTAGE

design\_ Stefano Mandruzzato

Elegante, semplice, raffinata.

Elegant, simple, refined.

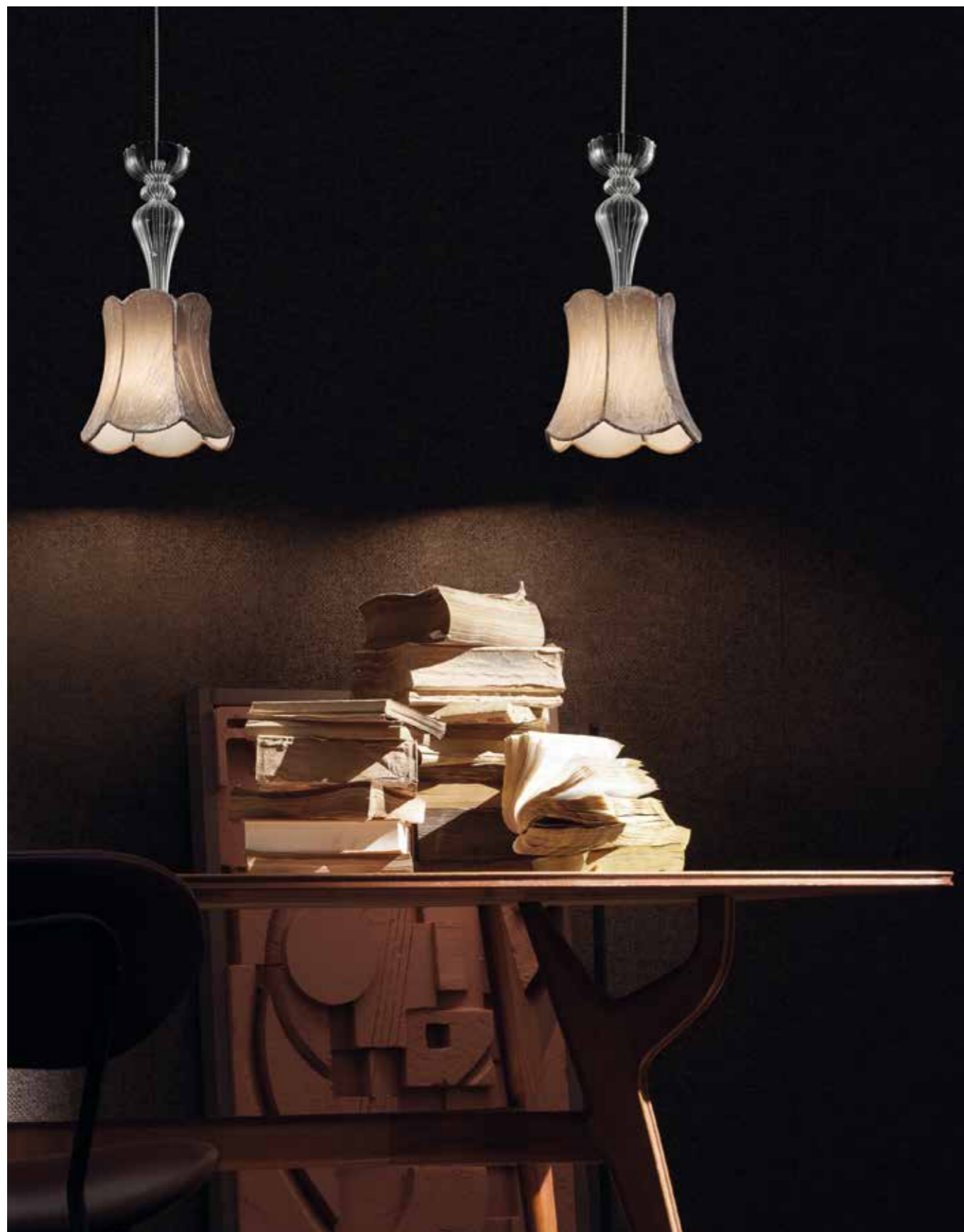

Vintage glass\_SO 2 BAROCCO



Vintage glass\_SO 5 PAGODA



Vintage\_SO 55 CAMPANA

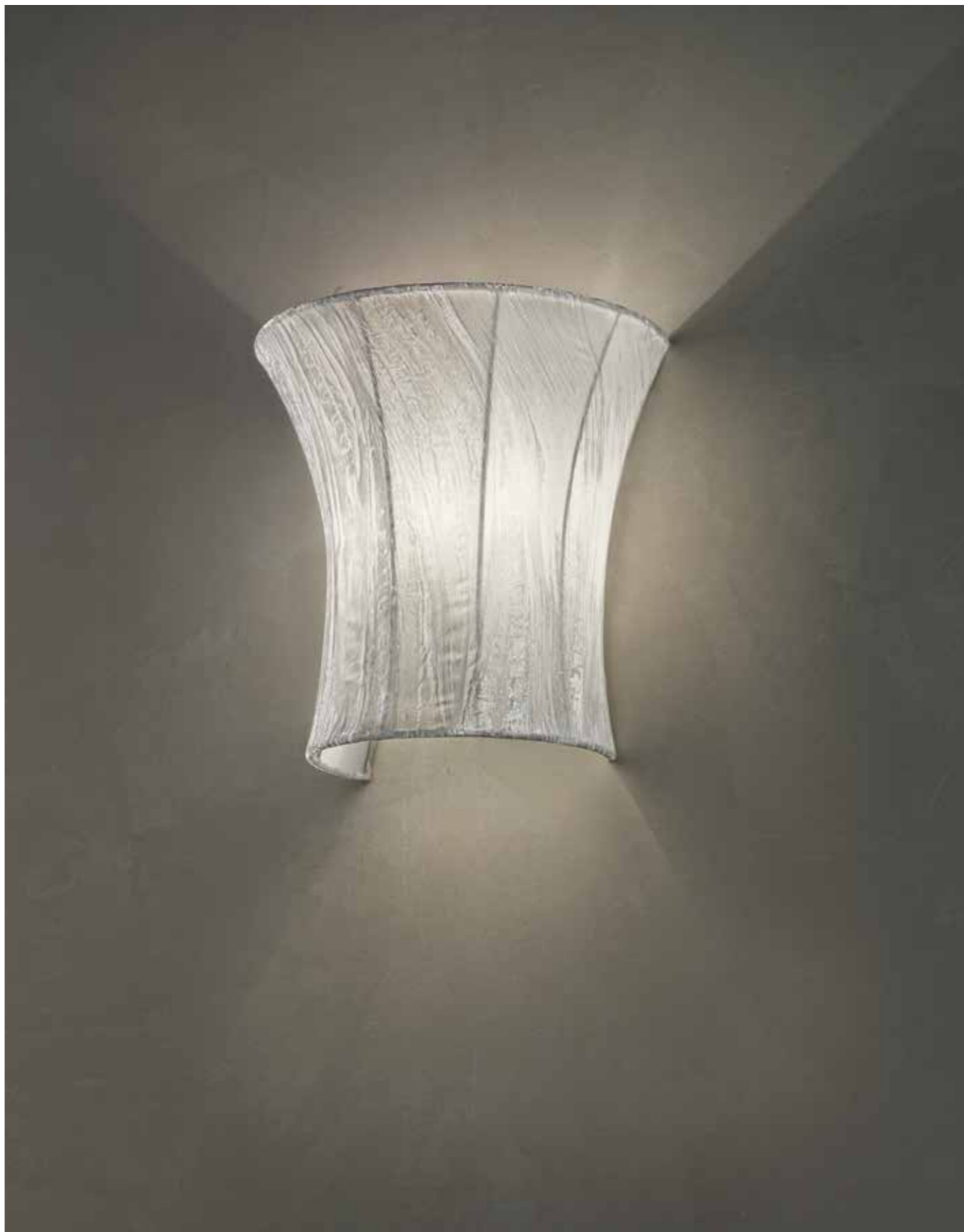

Vintage\_PA CAMPANA



Vintage\_SO 5 versione speciale/special version



Vintage\_SO 1 PAGODA



Vintage\_PA BAROCCO



Vintage\_SO 55 BAROCCO



Vintage\_PA PAGODA



Vintage\_SO 60 PAGODA







# VINTAGE

## \_technical data

Una collezione di lampade di ispirazione d'antan dall'eleganza attuale e dall'essenza innovativa.

I paralumi, in tre forme dall'inconfondibile richiamo vintage, sono rivestiti con un esclusivo velluto stropicciato, che ne rinnova lo stile e arricchisce la lampada di un prezioso effetto cangiante, che li rende unici.

Disponibile in eleganti colorazioni e in diverse versioni a sospensione e da parete, Vintage si accosta in maniera raffinata all'arredamento classico, creando al contrario brillanti contrasti con l'arredo più moderno.

La variante a sospensione piccola viene impreziosita da un elemento in vetro soffiato con la tipica lavorazione Muranese del "rigadin".

Une collection de lampes d'antan d'une élégance actuelle et à l'essence innovante.

Les abat-jours, aux trois formes rappelant le vintage de façon remarquable, sont revêtus d'un velours froissé exclusif, qui en renouvelle le style et enrichit la lampe d'un effet chatoyant précieux qui en fait des objets uniques.

Fournie dans d'élégantes couleurs et dans différentes versions à suspension et murales, Vintage peut-être assortie avec raffinement à un ameublement classique, en créant des contrastes brillants avec la décoration plus moderne.

La variante à petite suspension est enrichie d'un élément en verre soufflé suivant la méthode de travail typique de Murano appelée le "rigadin".

Current elegance and innovative essence: a collection of lamps inspired by a d'antan style. The exclusive crumpled velvet, with which the three vintage lampshades are coated, renews the style and enriches the lamp of a precious iridescent effect, which makes the shade unique.

Available in stylish colors and in different pendant and wall versions, Vintage adapts elegantly to the classic furnishing, creating, on the contrary, brilliant contrasts with the more modern furniture.

The version with the small pendant lamp is enhanced by an element in blown glass created through the typical Murano processing technique "rigadin".

Una colección de lámparas de inspiración de antaño, de elegancia actual y de esencia innovadora.

Las pantallas en tres formas de inconfundible evocación de antaño están forradas con un terciopelo arrugado y exclusivo que renueva el estilo y enriquece la lámpara con un preciso efecto cambiante haciéndolas únicas.

Disponibile en elegantes colores y en varias versiones, de suspensión y de pared, Vintage se combina en modo refinado con la decoración clásica creando al contrario brillantes contrastes con el mobiliario más moderno.

La variante de suspensión pequeña es valorizada por un elemento de vidrio soplado con el típico trabajo de Murano del "rigadin".

Eine Lampenkollektion nach historischer Inspiration, mit aktueller Eleganz und innovativer Essenz.

Die Lampenschirme mit ihren 3 unverwechselbaren Vintage-Formen sind mit einem exklusiven und zerknitterten Samtstoff verkleidet. Dieser erneuert ihren Stil und bereichert die Lampe mit einem edlen und irisierenden Effekt. Das macht sie einzigartig. Sie ist erhältlich in eleganten Farben und diversen Versionen mit Abhängung und für die Wandapplikation. Vintage integriert sich in edler Art und Weise in die klassische Einrichtung und erzeugt im Gegensatz brillante Kontraste mit der modernen Einrichtung. Die Ausführung mit kleiner Abhängung wird durch ein Element in geblasenem "Rigadin"-Glas mit der typischen "Murano"-Verarbeitung aufgewertet.

Коллекция светильников, созданная под вдохновением прошлого, с актуальной элегантностью и инновационной сущностью.

Уникальный велюр с эффектом жатости, из которого выполнены три винтажных абажура, обновляет стиль и придает светильнику эффект «шанжан», делая его уникальными.

Коллекция предоставляется в элегантных расцветках и различных версиях: подвесной и настенной, Vintage приближается в утонченной манере к классической обстановке, создавая, наоборот, превосходный контраст с самой современной обстановкой.

Маленький подвесной светильник украшен элементом из типичного дутого муранского стекла "rigadin".

**Struttura:** metallo cromato.  
**Diffusore:** paralume in velluto stropicciato nei colori: avorio, nero, rosso sultano, crema caffè, glicine, acquamarina e oro.

**Frame:** chromed metal.  
**Diffuser:** shade in crumpled velvet in: ivory, black, sultan-red, coffee-cream, wisteria, aquamarine and gold.

**Struktur:** Metall verchromt.  
**Diffusor:** Lampenschirm mit zerknittertem Samtstoff in den Farben: Elfenbein, Schwarz, Sultan Rot, Kaffeesahne, Glyzinie, Aquamarin und Gold.

**Structure:** métal chromé.  
**Diffuseur:** abat-jour en velours froissé dans les teintes ivoire, noir, rouge sultan, crème café, glycine, aigue-marine et or.

**Estructura:** metal cromado.  
**Difusor:** pantalla de terciopelo arrugado en los colores: marfil, negro, rojo sultán, crema de café, glicina, aguamarina y oro.

**Структура:** Хромированный металл.  
**Рассеиватель:** Абажур из велюра с эффектом жатости предоставляется в следующих вариантах цвета: слоновая кость, черный, темно-красный, кремовый, глициниевый, цвет морской волны и золотой.

### Campioni colore diffusore/Diffuser sample colors



**AQ:** Acquamare/  
Aquamarine



**GL:** Glicine/Wisteria



**AV:** Avorio/Ivory



**SR:** Rosso sultano/  
Sultan red

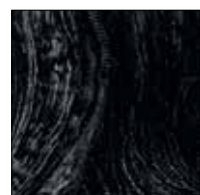

**NE:** Nero/Black



**OR:** Oro/Gold



**CC:** Crema caffè/  
Coffee cream

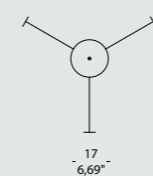
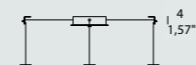

**VINTAGE RO-3**  
ROSONE A 3 LUCI  
3-LIGHT CANOPY

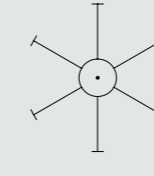
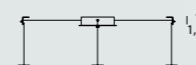

**VINTAGE RO-6**  
ROSONE A 6 LUCI  
6-LIGHT CANOPY

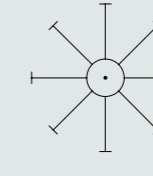
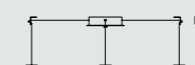

**VINTAGE RO-8**  
ROSONE A 8 LUCI  
8-LIGHT CANOPY

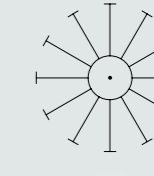

**VINTAGE RO-12**  
ROSONE A 12 LUCI  
12-LIGHT CANOPY



### SOSPENSIONI (CAVO STANDARD CM 350 + DECENTRAMENTO)/PENDANT LAMPS (STANDARD CABLE CM 350 + DECENTRAMENTO)

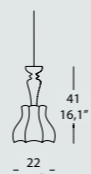

**VINTAGE GLASS SO S/R PAGODA**

1 x MAX 53W E27 alo. ENERGY SAVER  
o/or  
1 x MAX 8W E27 LED



**VINTAGE GLASS SO S/R BAROCCO**

1 x MAX 53W E27 alo. ENERGY SAVER  
o/or  
1 x MAX 8W E27 LED



**VINTAGE GLASS SO S/R CAMPANA**

1 x MAX 53W E27 alo. ENERGY SAVER  
o/or  
1 x MAX 8W E27 LED

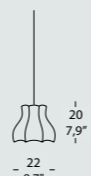

**VINTAGE SO S/R PAGODA**

1 x MAX 53W E27 alo. ENERGY SAVER  
o/or  
1 x MAX 8W E27 LED

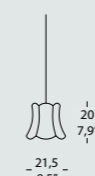
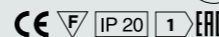

**VINTAGE SO S/R BAROCCO**

1 x MAX 53W E27 alo. ENERGY SAVER  
o/or  
1 x MAX 8W E27 LED

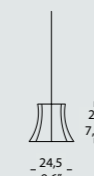

**VINTAGE SO S/R CAMPANA**

1 x MAX 53W E27 alo. ENERGY SAVER  
o/or  
1 x MAX 8W E27 LED

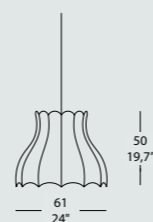

**VINTAGE SO60 S/R PAGODA**

1 x MAX 105W E27 alo. ENERGY SAVER  
o/or  
1 x MAX 21W E27 LED

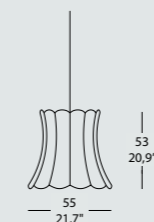

**VINTAGE SO55 S/R BAROCCO**

1 x MAX 105W E27 alo. ENERGY SAVER  
o/or  
1 x MAX 21W E27 LED

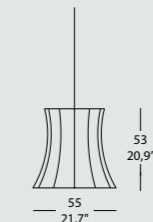

**VINTAGE SO55 S/R CAMPANA**

1 x MAX 105W E27 alo. ENERGY SAVER  
o/or  
1 x MAX 21W E27 LED



\_technical data

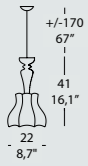

**VINTAGE GLASS SO 1 PAGODA**

1 x MAX 53W E27 a.l.o. ENERGY SAVER  
o/or  
1 x MAX 8W E27 LED   
CE IP 20

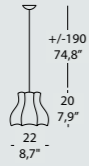

**VINTAGE SO 1 PAGODA**

1 x MAX 53W E27 a.l.o. ENERGY SAVER  
o/or  
1 x MAX 8W E27 LED   
CE IP 20

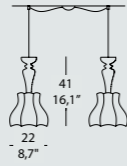

**VINTAGE GLASS SO 2 PAGODA**

2 x MAX 53W E27 a.l.o. ENERGY SAVER  
o/or  
2 x MAX 8W E27 LED   
CE IP 20

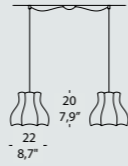

**VINTAGE SO 2 PAGODA**

2 x MAX 53W E27 a.l.o. ENERGY SAVER  
o/or  
2 x MAX 8W E27 LED   
CE IP 20

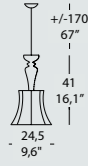

**VINTAGE GLASS SO 1 CAMPANA**

1 x MAX 53W E27 a.l.o. ENERGY SAVER  
o/or  
1 x MAX 8W E27 LED   
CE IP 20

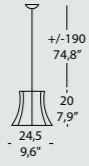

**VINTAGE SO 1 CAMPANA**

1 x MAX 53W E27 a.l.o. ENERGY SAVER  
o/or  
1 x MAX 8W E27 LED   
CE IP 20

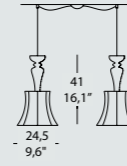

**VINTAGE GLASS SO 2 CAMPANA**

2 x MAX 53W E27 a.l.o. ENERGY SAVER  
o/or  
2 x MAX 8W E27 LED   
CE IP 20

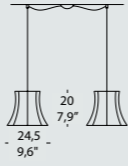

**VINTAGE SO 2 CAMPANA**

2 x MAX 53W E27 a.l.o. ENERGY SAVER  
o/or  
2 x MAX 8W E27 LED   
CE IP 20

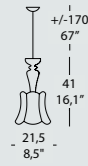

**VINTAGE GLASS SO 1 BAROCCO**

1 x MAX 53W E27 a.l.o. ENERGY SAVER  
o/or  
1 x MAX 8W E27 LED   
CE IP 20

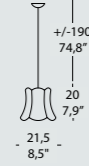

**VINTAGE SO 1 BAROCCO**

1 x MAX 53W E27 a.l.o. ENERGY SAVER  
o/or  
1 x MAX 8W E27 LED   
CE IP 20

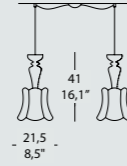

**VINTAGE GLASS SO 2 BAROCCO**

2 x MAX 53W E27 a.l.o. ENERGY SAVER  
o/or  
2 x MAX 8W E27 LED   
CE IP 20

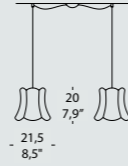

**VINTAGE SO 2 BAROCCO**

2 x MAX 53W E27 a.l.o. ENERGY SAVER  
o/or  
2 x MAX 8W E27 LED   
CE IP 20

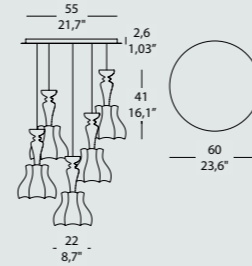

**VINTAGE GLASS SO 5 PAGODA**

5 x MAX 53W E27 a.l.o. ENERGY SAVER  
o/or  
5 x MAX 8W E27 LED   
CE IP 20

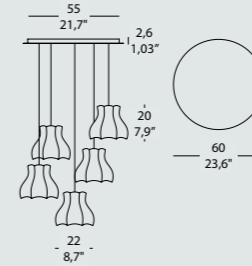

**VINTAGE SO 5 PAGODA**

5 x MAX 53W E27 a.l.o. ENERGY SAVER  
o/or  
5 x MAX 8W E27 LED   
CE IP 20

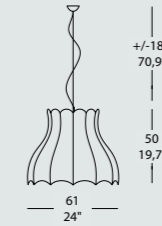

**VINTAGE SO 60 PAGODA**

1 x MAX 105W E27 a.l.o. ENERGY SAVER  
o/or  
1 x MAX 21W E27 LED   
CE IP 20

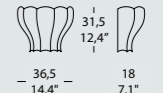

**VINTAGE PA PAGODA**

1 x MAX 70W E27 a.l.o. ENERGY SAVER  
o/or  
1 x MAX 12W E27 LED   
CE IP 20

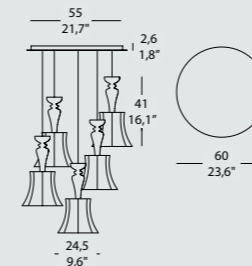

**VINTAGE GLASS SO 5 CAMPANA**

5 x MAX 53W E27 a.l.o. ENERGY SAVER  
o/or  
5 x MAX 8W E27 LED   
CE IP 20

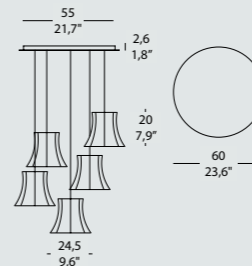

**VINTAGE SO 5 CAMPANA**

5 x MAX 53W E27 a.l.o. ENERGY SAVER  
o/or  
5 x MAX 8W E27 LED   
CE IP 20

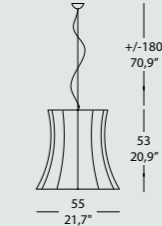

**VINTAGE SO 55 CAMPANA**

1 x MAX 105W E27 a.l.o. ENERGY SAVER  
o/or  
1 x MAX 21W E27 LED   
CE IP 20

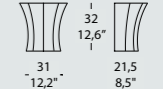

**VINTAGE PA CAMPANA**

1 x MAX 70W E27 a.l.o. ENERGY SAVER  
o/or  
1 x MAX 12W E27 LED   
CE IP 20

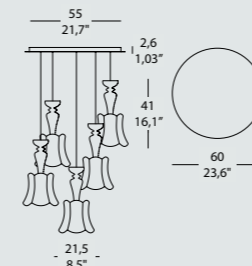

**VINTAGE GLASS SO 5 BAROCCO**

5 x MAX 53W E27 a.l.o. ENERGY SAVER  
o/or  
5 x MAX 8W E27 LED   
CE IP 20

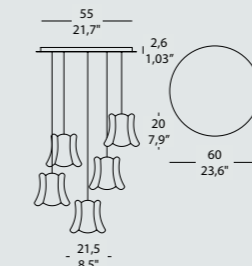

**VINTAGE SO 5 BAROCCO**

5 x MAX 53W E27 a.l.o. ENERGY SAVER  
o/or  
5 x MAX 8W E27 LED   
CE IP 20

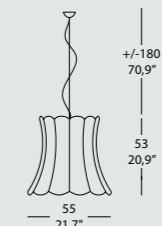

**VINTAGE SO 55 BAROCCO**

1 x MAX 105W E27 a.l.o. ENERGY SAVER  
o/or  
1 x MAX 21W E27 LED   
CE IP 20

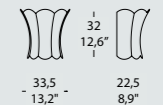

**VINTAGE PA BAROCCO**

1 x MAX 70W E27 a.l.o. ENERGY SAVER  
o/or  
1 x MAX 12W E27 LED   
CE IP 20



# GADORA

design\_Romani Sacconi  
Architetti Associati

Spazio all'eleganza,  
ricercatezza in ogni dettaglio.

Ultimate style and refinement  
in every detail.



Gadora\_TE S1



Gadora\_S2L



Gadora\_TE S5



Gadora\_CO





Gadora\_S06



Gadora\_S4L





Gadora\_PA1 S



Gadora\_PA 1

## \_technical data

Gadora è un incontro tra eccellenze del Made in Italy.

Abbina la sapienza della lavorazione artistica di Murano al ricercato design di Evi Style. Gadora è un incontro tra più eleganze. Accosta il vetro soffiato "rigadin", mosso e scolpito in nervature parallele, a paralumi d'organza in raffinate colorazioni. Gadora è una collezione di lampade dall'armonia estetica unica, che riempie l'ambiente di esclusività ma nello stesso tempo lascia la possibilità di personalizzare lo spazio in funzione delle proprie esigenze di arredamento e di stile. La particolare caratteristica delle lampade a sospensione, infatti, permette oltre alle modalità riportate a catalogo, l'installazione con altezze differenti e la possibilità di creare delle composizioni con forme irregolari diversificando sempre la configurazione finale. Una soluzione assolutamente elegante.

Gadora is the fusion of Made in Italy excellences. The wisdom of the Murano artistic works and the sophisticated Evi Style design are combined. Gadora is a meeting between different kinds of elegance. It represents the juxtaposition of the wavy blown glass "rigadin", with parallel ribs, and organza lampshades in refined colors. The unique aesthetic harmony of the Gadora collection makes the environment exclusive but at the same time gives the possibility to customize the space, to meet your needs in style and furniture. In addition to the options shown in our catalogue, the distinctive feature of these suspension lamps is that you can customize the pendants at different heights or create compositions of variable shapes, offering thus enhanced flexibility in terms of configuration. A completely elegant solution.

Gadora ist ein Zusammentreffen der Spitzenelemente des Made in Italy. Es verbindet das Wissen der künstlerischen Murano-Bearbeitung mit dem ausgesuchten Design von Evi Style. Gadora ist das Zusammentreffen höherer Eleganz. Es verbindet das geblasene "Rigadin"-Glas, das in parallelen Rippen bewegt und eingemeißelt ist, mit Organza-Lampenschirmen in eleganten Farben. Gadora ist eine Lampenkollektion mit einer einzigartigen ästhetischen Harmonie, das die Umgebung mit Exklusivität füllt, aber gleichzeitig die Möglichkeit lässt, den Raum nach Wunsch und gemäß dem Einrichtungsstil individuell zu gestalten. Die besondere Eigenschaft dieser Hängelampen gestattet die Installation, außer den im Katalog angeführten Möglichkeiten, in verschiedenen Höhen und somit eine phantasiereiche Zusammensetzung mit stets neuen Konfigurationen. Eine absolut elegante Lösung.

Gadora est la rencontre des excellences du Made in Italy.

Elle associe le savoir du travail artistique de Murano au design raffiné d'Evi Style. Gadora est la rencontre de plusieurs élégances. Elle assortit le verre soufflé "rigadin", ondulé et sculpté en nervures parallèles, à des abat-jour en organza aux teintes raffinées. Gadora est une collection de lampes présentant une harmonie esthétique unique, qui remplit la pièce d'exclusivité tout en permettant de personnaliser l'espace en fonction des exigences personnelles de décoration et de style. La caractéristique des lampes à suspension permet, en effet, de réaliser les installations proposées dans le catalogue, mais aussi de les placer à des hauteurs différentes et de créer des compositions aux formes irrégulières diversifiant constamment la configuration finale. Une solution absolument élégante.

Gadora es un encuentro entre las excelencias del encuentro del Made in Italy. Combina la sabiduría del trabajo artístico de Murano con el rebuscado design de Evi Style. Gadora es un encuentro entre varias elegancias. Acerca el vidrio soplado "rigadin", movido y esculpido en nervios paralelos, a pantallas de organza en refinados colores. Gadora es una colección de lámparas de armonía estética única, que llena el ambiente de exclusividad pero al mismo tiempo deja la posibilidad de personalizar el espacio en función de las propias exigencias de decoración y de estilo. La peculiaridad estructural de las lámparas de suspensión permite, además de los modos previstos en el catálogo, la instalación con alturas diferentes creando además composiciones de formas irregulares, diversificando siempre la configuración final. Una solución absolutamente elegante.

Gadora – это встреча исключительностей Made in Italy.

Соединяет знание в области производства художественного муранского стекла и изысканный дизайн Evi Style. Gadora – это встреча элегантностей. Дутое стекло "rigadin", приведенное в движение и вылепленное в виде параллельных рифлений, соединено с абажурами из органзы изысканной цветовой гаммы. Gadora – коллекция светильников, характеризующая неповторимой эстетикой, наполняющая пространство эксклюзивностью, оставляя в то же время возможность для персонификации пространства, в зависимости от личных потребностей и стиля. Характерной деталью подвесных светильников, помимо модульности, указанной в каталоге, является возможность их установки на разной высоте и возможность создания композиций с оригинальными формами, дифференцируя конечную конфигурацию. Представляет собой абсолютно элегантное решение.

**Struttura:** metallo cromato.

**Vetro:** soffiato "rigadin".

**Diffusore:** paralumi in organza ignifuga classe 1 nei colori: avorio, bianco, bordeaux, grigio-cromo, e golden teak.

**Frame:** chromed metal.

**Glass:** blown "rigadin".

**Diffuser:** organza fireproof class 1 lampshades in these colors: ivory, white, burgundy, grey-chrome, and golden teak.

**Struktur:** Metall verchromt.

**Glas:** Geblasenes "Rigadin"-Glas.

**Diffusor:** Lampenschirme aus feuerfestem Organza, Klasse 1, in den Farben: Elfenbein, Weiß, Bordeaux, Grau-Chrom, und Golden Teak.

**Structure:** métal chrome.

**Verre:** soufflé "rigadin".

**Diffuseur:** abat-jour en organza ignifuge de la classe 1 dans les couleurs: ivoire, blanc, bordeaux, gris-chrome, et golden teak.

**Estructura:** metal cromado.

**Vidrio:** soplado "rigadin".

**Difusor:** pantallas en organza ignifugas clase 1 en los colores: marfil, blanco, burdeos, gris-cromo, y golden teak.

**Структура:** хромированный металл.

**Стекло:** дутое стекло "rigadin".

**Рассеиватель:** абажуры из огнестойкой органзы класса 1 могут быть выполнены в следующих цветах: цвет слоновой кости, белый, бордовый, серый-хром и золотой тик.



**AV:** Avorio/Ivory



**BI:** Bianco/White



**CR:** Grigio-Cromo/  
Chrome-Grey



**GT:** Golden teak



**BX:** Bordeaux/Burgundy

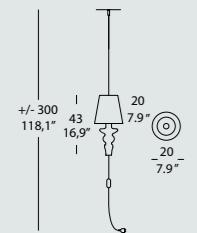

### GADORA TE S1

1 x MAX 42W E14 alo. ENERGY SAVER

o/or

1 x MAX 6W E14 LED

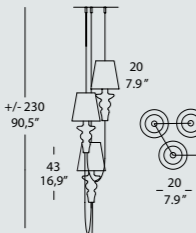
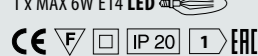

### GADORA TE S3

3 x MAX 42W E14 alo. ENERGY SAVER

o/or

3 x MAX 6W E14 LED DIM

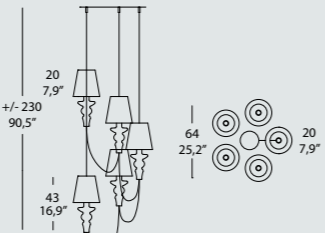
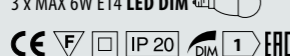

### GADORA TE S5

5 x MAX 42W E14 alo. ENERGY SAVER

o/or

5 x MAX 6W E14 LED DIM

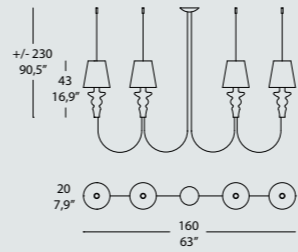
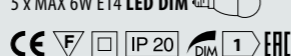

### GADORA S4L

4 x MAX 42W E14 alo. ENERGY SAVER

o/or

4 x MAX 6W E14 LED

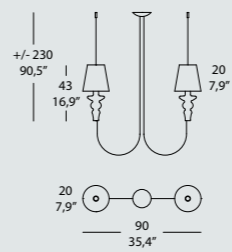
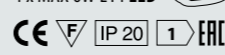

### GADORA S2L

2 x MAX 42W E14 alo. ENERGY SAVER

o/or

2 x MAX 6W E14 LED

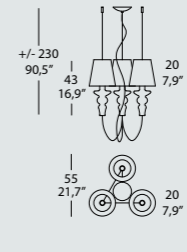
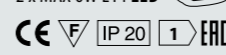

### GADORA SO 3

3 x MAX 42W E14 alo. ENERGY SAVER

o/or

3 x MAX 6W E14 LED

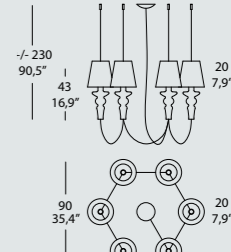
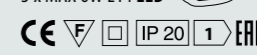

### GADORA SO 6

6 x MAX 42W E14 alo. ENERGY SAVER

o/or

6 x MAX 6W E14 LED

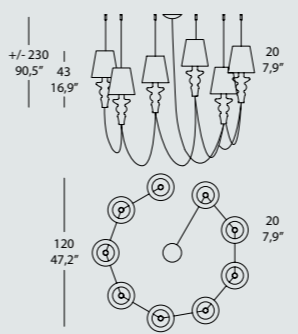
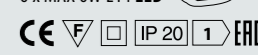

### GADORA SO 9

9 x MAX 42W E14 alo. ENERGY SAVER

o/or

9 x MAX 6W E14 LED

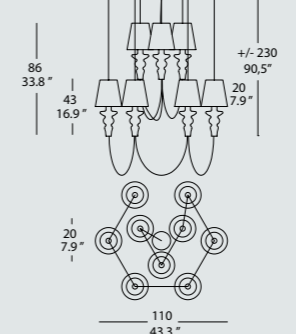

### GADORA SO 6+3

9 x MAX 42W E14 alo. ENERGY SAVER

o/or

9 x MAX 6W E14 LED

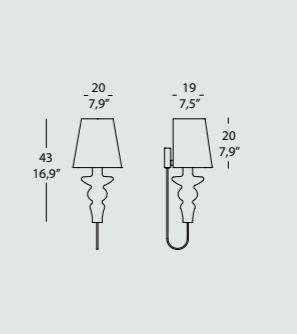
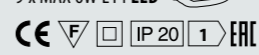

### GADORA PA 1

1 x MAX 42W E14 alo. ENERGY SAVER

o/or

1 x MAX 6W E14 LED

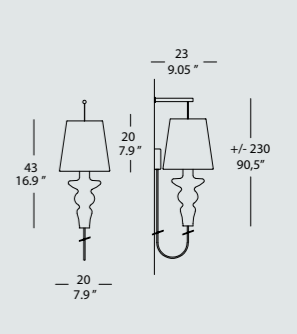
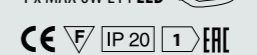

### GADORA PA1 M

1 x MAX 42W E14 alo. ENERGY SAVER

o/or

1 x MAX 6W E14 LED

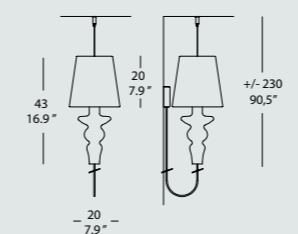
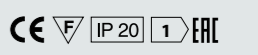

### GADORA PA1 S

1 x MAX 42W E14 alo. ENERGY SAVER

o/or

1 x MAX 6W E14 LED

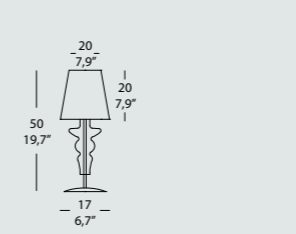
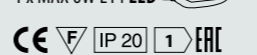

### GADORA CO

1 x MAX 42W E14 alo. ENERGY SAVER

o/or

1 x MAX 6W E14 LED





# GADORA CHIC

design\_Romani Sacconi  
Architetti Associati

Evoluzione di un classico  
di successo.

The evolution of a timeless  
classic.



Gadora Chic\_SO 3



Gadora Chic\_ esempio di composizione a 10 luci/10 lights composition example



Gadora Chic\_SO 6+3



Gadora Chic\_PA 1



Gadora Chic\_CO



Gadora Chic\_TE S3



Gadora Chic\_PA 1 S



Gadora Chic\_PA 1 M

# GADORA CHIC

Modello Europeo Registrato  
European Registered Design

## \_technical data

L'eleganza del vetro soffiato, la raffinatezza dei paralumi in organza, la preziosità delle finiture in bianco, cromo e oro 24 kt. Ogni dettaglio della collezione di lampade Gadora Chic parla di classe e di stile. Uno stile unico, immediatamente riconoscibile, ma nello stesso tempo personalizzabile in funzione dello spazio e delle scelte d'arredamento. La particolare caratteristica delle lampade a sospensione infatti, permette oltre alle modalità riportate a catalogo, l'installazione con altezze differenti e la possibilità di creare delle composizioni con forme irregolari, diversificando sempre la configurazione finale. Le potenzialità creative sono molteplici. Così come le probabilità di rimanere abbagliati dalla sua bellezza.

L'élégance du verre soufflé, le raffinement des abat-jour en organza, la préciosité des finitions blanc, chrome et or 24 carats. Chaque détail de la collection de lampes Gadora Chic parle de classe et de style. Un style unique, immédiatement reconnaissable, mais en même temps personnalisable en fonction de l'espace et des choix de décoration. La caractéristique des lampes à suspension permet, en effet, de réaliser les installations proposées dans le catalogue, mais aussi de les placer à des hauteurs différentes et de créer des compositions aux formes irrégulières diversifiant constamment la configuration finale. Les potentiels créatifs sont nombreux. Tout comme la probabilité d'être ébloui par sa beauté.

The elegance of blown glass, the refined organza lampshades, the precious finishes in white, chrome and gold 24 kt. Each detail of the Gadora Chic collection is an element of class and style. A unique and immediately recognizable style but at the same time customizable, according to the choices of space and furniture. In addition to the options shown in our catalogue, as a matter of fact, the distinctive feature of these suspension lamps is that you can customize the pendants at different heights or create compositions of variable shapes, thus offering enhanced flexibility in terms of configuration. There are lots of creative possibilities. As well as the chances of getting dazzled by her beauty.

La elegancia del vidrio soplado, la sofisticación de las pantallas en organza, la preciosidad de los acabados en blanco, cromo y oro 24 kt. Cada detalle de la colección de lámparas Gadora Chic habla de clase y de estilo. Un estilo único, inmediatamente reconocible, pero al mismo tiempo personalizable en función del espacio y de las elecciones de decoración. En efecto, las particulares características de las lámparas de suspensión permite además de los modos indicados en el catálogo, la instalación con alturas diferentes y la posibilidad de crear composiciones con formas irregulares, diversificando siempre la configuración final. Las potencialidades creativas son múltiples así como las probabilidades de quedar deslumbrados por su belleza.

Die Eleganz des geblasenen Glases, die Erlesenheit der Organza-Lampenschirme, der Wert der Verarbeitungen in Weiß, Chrom und 24 kt. Gold. Jedes Detail der Lampenkollektion Gadora Chic spricht von Klasse und Stil. Ein einzigartiger Stil, der sofort erkennbar ist, aber gleichzeitig je nach Raum und Einrichtungsstil individuell gestaltbar ist. Die besondere Eigenschaft dieser Hängelampen gestattet die Installation, zusätzlich zu der im Katalog angeführten Option, in verschiedenen Höhen und somit eine phantasiereiche Zusammensetzung mit stets neuen Konfigurationen. Die kreativen Möglichkeiten sind zahlreich. Wie auch die Wahrscheinlichkeit von ihrer Schönheit geblendet zu werden.

Элегантность дутого стекла, утонченность абажуров из органзы, изысканность белой, хромовой и золотой 24К отделок. Каждая деталь коллекции светильников Gadora Chic говорит о классе и стиле. Уникальный стиль, незамедлительно узнаваемый, оставляет в то же время возможность для персонификации пространства, в зависимости от личных потребностей и стиля. Характерной деталью подвесных светильников, помимо модульности, указанной в каталоге, является возможность их установки на разной высоте и возможность создания композиций с оригинальными формами, дифференцируя конечную конфигурацию. Заключает в себе многообразный творческий потенциал наряду с вероятностью потрясти своей красотой.

**Struttura:** metallo cromato o oro 24 kt.

**Frame:** chromed metal or gold 24 kt.

**Struktur:** Metall verchromt oder 24 kt. Gold.

**Structure:** métal chromé ou or 24 carats.

**Estructura:** metal cromado u oro 24 kt.

**Структура:** хромированный металл или золото 24К.

**Vetro:** soffiato nei colori: bianco, metallizzato cromo e metallizzato oro.

**Glass:** blown in the colors: white, metalized chrome and metalized gold.

**Glas:** Geblasen in den Farben Weiß, metallisches Chrom oder metallisches Gold.

**Verre:** souffler dans les couleurs: blanc, métallisé chrome et métallisé or.

**Vidrio:** soplado en los colores: blanco, metalizado cromo y metalizado oro.

**Стекло:** дутое стекло выполняется в следующих цветах: белое, металлизированное хром и металлизированное золото.

**Diffusore:** paralumi in organza ignifuga classe 1 nei colori: bianco, grigio-cromo e oro.

**Diffuser:** organza fireproof class 1 lampshades in the colors: white, grey-chrome and gold.

**Diffusor:** Lampenschirme aus feuerfestem Organza, Klasse 1, in den Farben: Weiß, Grau-Chrom und Gold.

**Diffuseur:** abat-jour en organza ignifuge de la classe 1 dans les couleurs: blanc, gris-chrome et golden teak.

**Difusor:** pantallas en organza ignifuga clase 1 en los colores: blanco, gris-cromo y oro.

**Рассеиватель:** абажуры из огнестойкой органзы класса 1 могут быть выполнены в следующих цветах: белый, серый хром и золотой.



**BI:** Bianco/White

**CR:** Grigio-Cromo/Chrome-Grey

**OR:** Oro/Gold

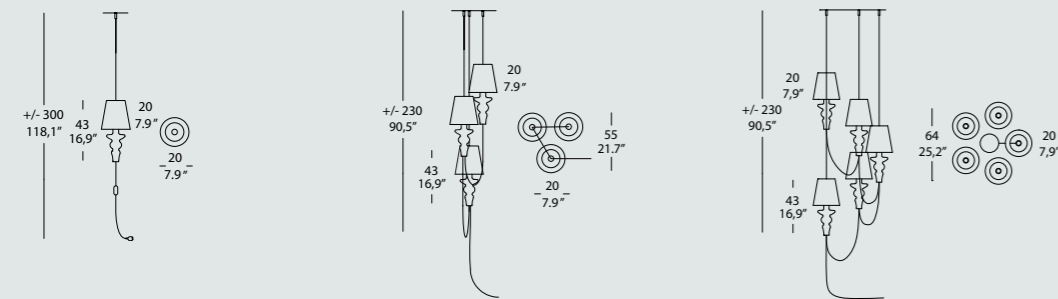

### GADORA CHIC TE S1

1 x MAX 42W E14 alo. ENERGY SAVER  
o/or

1 x MAX 6W E14 LED



### GADORA CHIC TE S3

3 x MAX 42W E14 alo. ENERGY SAVER  
o/or

3 x MAX 6W E14 LED DIM

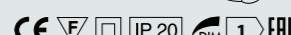

### GADORA CHIC TE S5

5 x MAX 42W E14 alo. ENERGY SAVER  
o/or

5 x MAX 6W E14 LED DIM

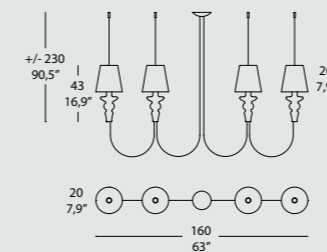
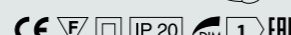

### GADORA CHIC S4L

4 x MAX 42W E14 alo. ENERGY SAVER  
o/or

4 x MAX 6W E14 LED

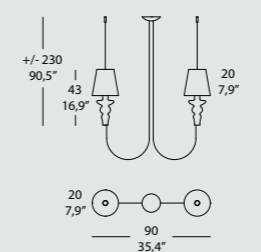
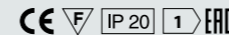

### GADORA CHIC S2L

2 x MAX 42W E14 alo. ENERGY SAVER  
o/or

2 x MAX 6W E14 LED

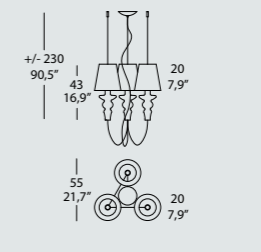

### GADORA CHIC SO 3

3 x MAX 42W E14 alo. ENERGY SAVER  
o/or

3 x MAX 6W E14 LED

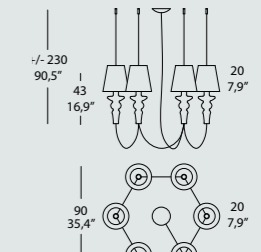

### GADORA CHIC SO 6

6 x MAX 42W E14 alo. ENERGY SAVER  
o/or

6 x MAX 6W E14 LED

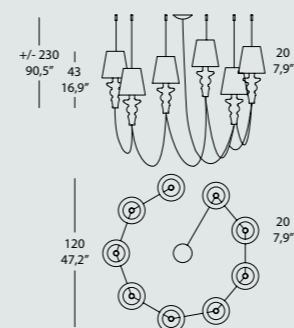

### GADORA CHIC SO 9

9 x MAX 42W E14 alo. ENERGY SAVER  
o/or

9 x MAX 6W E14 LED

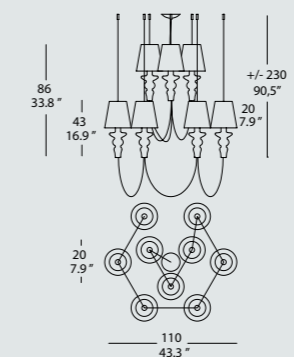

### GADORA CHIC SO 6+3

9 x MAX 42W E14 alo. ENERGY SAVER  
o/or

9 x MAX 6W E14 LED

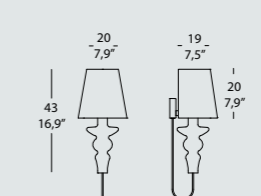

### GADORA CHIC PA 1

1 x MAX 42W E14 alo. ENERGY SAVER  
o/or

1 x MAX 6W E14 LED

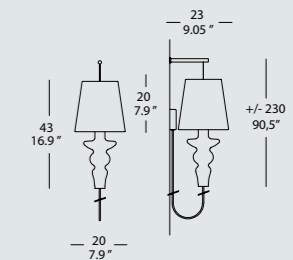

### GADORA CHIC PA 1 M

1 x MAX 42W E14 alo. ENERGY SAVER  
o/or

1 x MAX 6W E14 LED

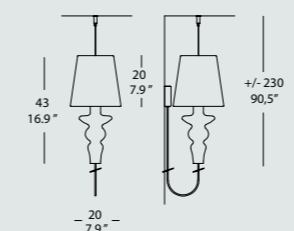

### GADORA CHIC PA 1 S

1 x MAX 42W E14 alo. ENERGY SAVER  
o/or

1 x MAX 6W E14 LED

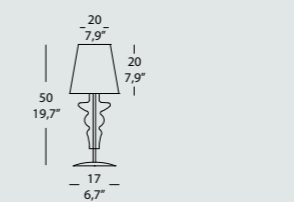
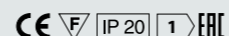

### GADORA CHIC CO

1 x MAX 42W E14 alo. ENERGY SAVER  
o/or

1 x MAX 6W E14 LED







# TEARS

design\_Stefano Mandruzzato

Stille di raffinata intimità.

A cascade of intimate luxury.



Tears\_PA 1



Tears\_SO 60



# TEARS

## \_technical data

Dietro ogni lacrima si nasconde una storia. Dietro la collezione di lampade Tears si nasconde una storia fatta di ricerca continua dell'eccellenza tecnica ed estetica, finalizzata alla creazione di oggetti di design che illuminino di eleganza e di prestigio l'arredamento più ricercato: in una parola, la storia di Evi Style. Il vetro soffiato "rigadin", il contrasto nei paralumi tra la pelle increspata all'esterno e l'interno metallizzato, le finiture in cromo e oro 24 carati: dettagli esclusivi declinati in modo del tutto originale nelle diverse versioni della collezione.

Chaque larme cache une histoire. Derrière la collection de lampes Tears se cache une histoire faite de recherche constante de l'excellence technique et esthétique, ayant pour but la création d'objets de design qui éclairent d'élégance et de prestige la décoration la plus raffinée: en un mot l'histoire d'Evi Style. Le verre soufflé "rigadin", le contraste au niveau des abat-jour entre le cuir froissé à l'extérieur et l'intérieur métallisé, les finitions en chrome et en or 24 carats: des détails exclusifs déclinés de manière tout à fait originale dans les différentes versions de la collection.

Behind each tear there is a story. Behind the lamp collection Tears there is a story of continuous search for technical and aesthetic excellence, aimed at the creation of design objects that illuminate the elegance and prestige of the most refined furniture: in a word, the Evi Style history. The blown glass "rigadin", the contrast between the wrinkled eco-leather outside and the inside metalized, the chrome and gold 24kt finish: exclusive details in an original composition, in different versions of the collection.

Detrás de cada lágrima se esconde una historia. Detrás de la colección de lámparas Tears se esconde una historia de búsqueda continua de la excelencia técnica y estética, finalizada a la creación de objetos de design que iluminen de elegancia y de prestigio la decoración más rebuscada: en una palabra, la historia de Evi Style. El vidrio soplado "rigadin", el contraste en las pantallas entre la piel encrespada al exterior y el interior metalizado, los acabados en cromo y oro 24 quilates: detalles exclusivos declinados en modo del todo original en las varias versiones de la colección.

Hinter jeder Träne verbirgt sich eine Geschichte. Hinter der Lampenkollektion Tears verbirgt sich eine Geschichte, die aus der ständigen Suche nach technischer und ästhetischer Spitzenqualität besteht. Letztendlich um Designobjekte zu kreieren, die mit Eleganz und Kostbarkeit die erlesensten Einrichtungen erleuchten. In einem Wort, die Geschichte von Evi Style. Das geblasene "Rigadin"-Glas, der Kontrast in den Lampenschirmen zwischen dem gekräuselten Leder außen und dem Metallis-Innenbereich, die Chrom- und 24 kt. Gold-Verarbeitungen: exklusive Details, die originell in den verschiedenen Ausführungen der Kollektion zur Schau gestellt werden.

В каждой слезе таится история. Коллекцией Tears таит в себе историю непрерывного поиска в области технического совершенства и эстетики, нацеленного на создание предметов дизайна, которые озаряют элегантно и престижем самые изысканные интерьерные обстановки: одним словом, история Evi Style. Дутое стекло "rigadin", контраст жатой кожи внешней части абажура и его внутренней металлизированной частью, отделка хром и золото 24 К: эксклюзивные детали, оригинальным образом нашедшие свое выражение в различных версиях коллекции.

<b>Struttura:</b> metallo cromato o oro 24 kt.	<b>Frame:</b> chromed metal or gold 24 kt.	<b>Struktur:</b> Metall verchromt oder 24 kt. Gold.	<b>Structure:</b> métal chromé ou or 24 carats.	<b>Estructura:</b> metal cromado u oro 24 kt.	<b>Структура:</b> хромированный металл или золото 24 К.
<b>Vetro:</b> soffiato "rigadin".	<b>Glass:</b> blown "rigadin".	<b>Glas:</b> Geblasenes "Rigadin"-Glas.	<b>Verre:</b> soufflé "rigadin".	<b>Vidrio:</b> soplado "rigadin".	<b>Стекло:</b> дутое стекло "rigadin".
<b>Diffusore:</b> paralumi in eco pelle stropicciata nei colori: nero con interno oro lucido e bianco con interno argento lucido.	<b>Diffuser:</b> wrinkled eco-leather lampshades in these colors: black with gold polished finish inside and white with silver polished finish inside.	<b>Diffusor:</b> Lampenschirme aus verknittertem Ökoleder, in den Farben: Schwarz mit Innenbereich in Glanzgold und Weiß mit Glanzsilber.	<b>Diffuseur:</b> abat-jour en cuir écologique froissé dans les couleurs noir avec intérieur or brillant et blanc avec intérieur argent brillant.	<b>Difusor:</b> pantallas en eco piel arrugada en los colores: negro con interno en oro brillante y blanco con interno en plata brillante.	<b>Рассветатель:</b> абажуры из жатой экокожи: черный цвет с блестящей золотой внутренней частью и белый цвет с блестящей серебряной внутренней частью.

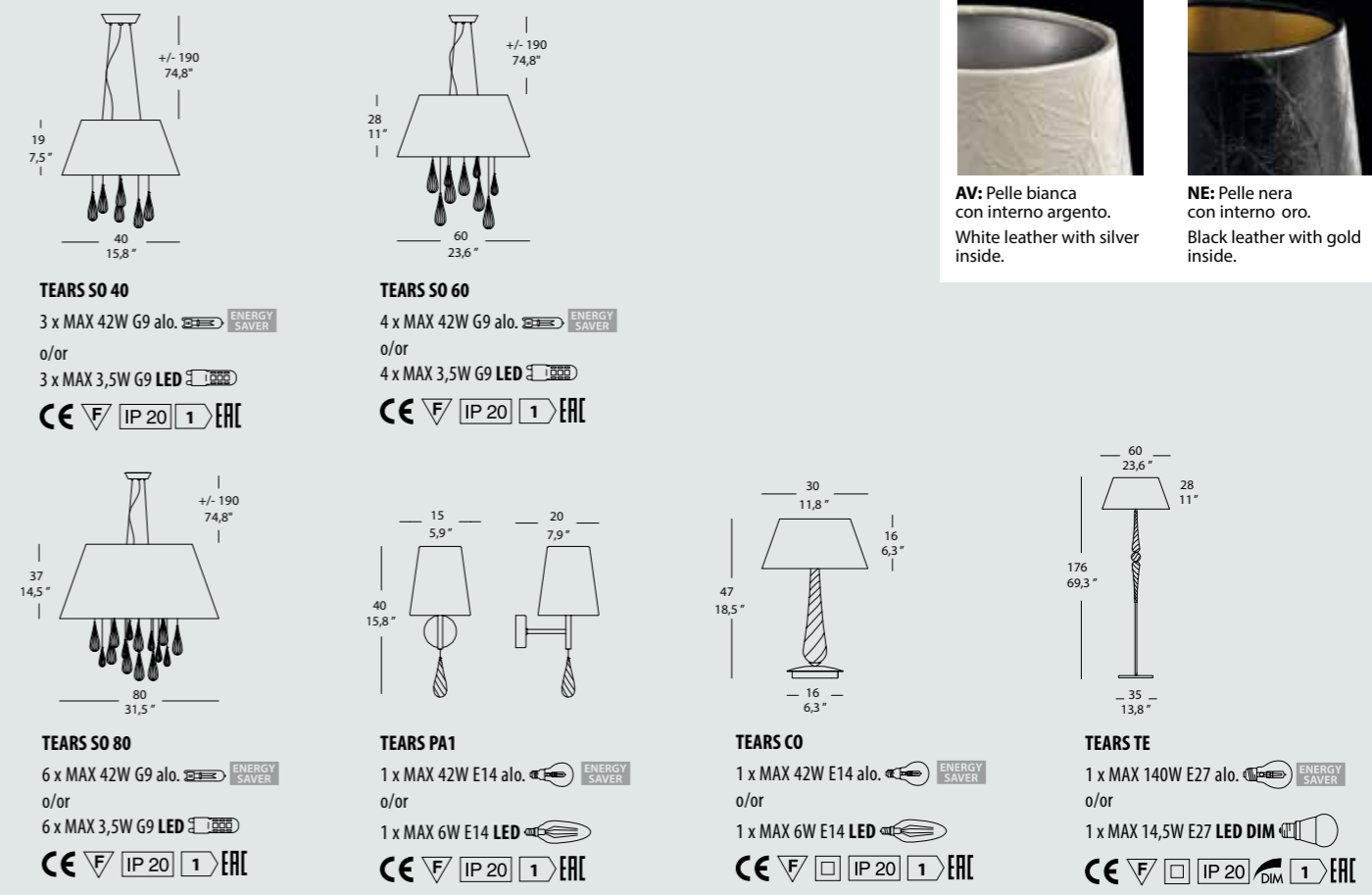



# SAN MARCO

design\_Romani Sacconi  
Architetti Associati

L'anima di Venezia  
che illumina i nostri tempi.

The soul of Venice  
illuminates our time.



San Marco\_SO 7

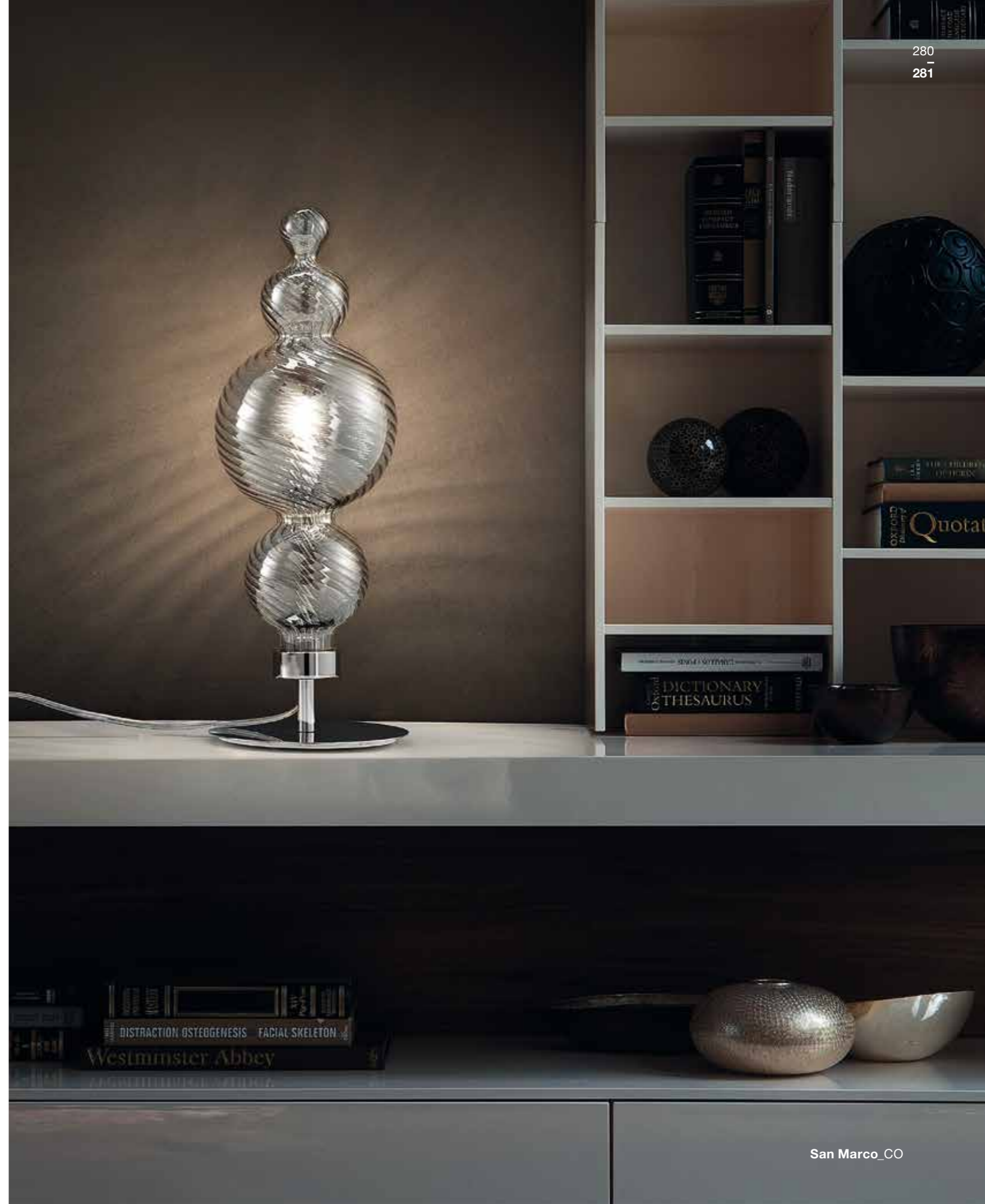

San Marco\_CO

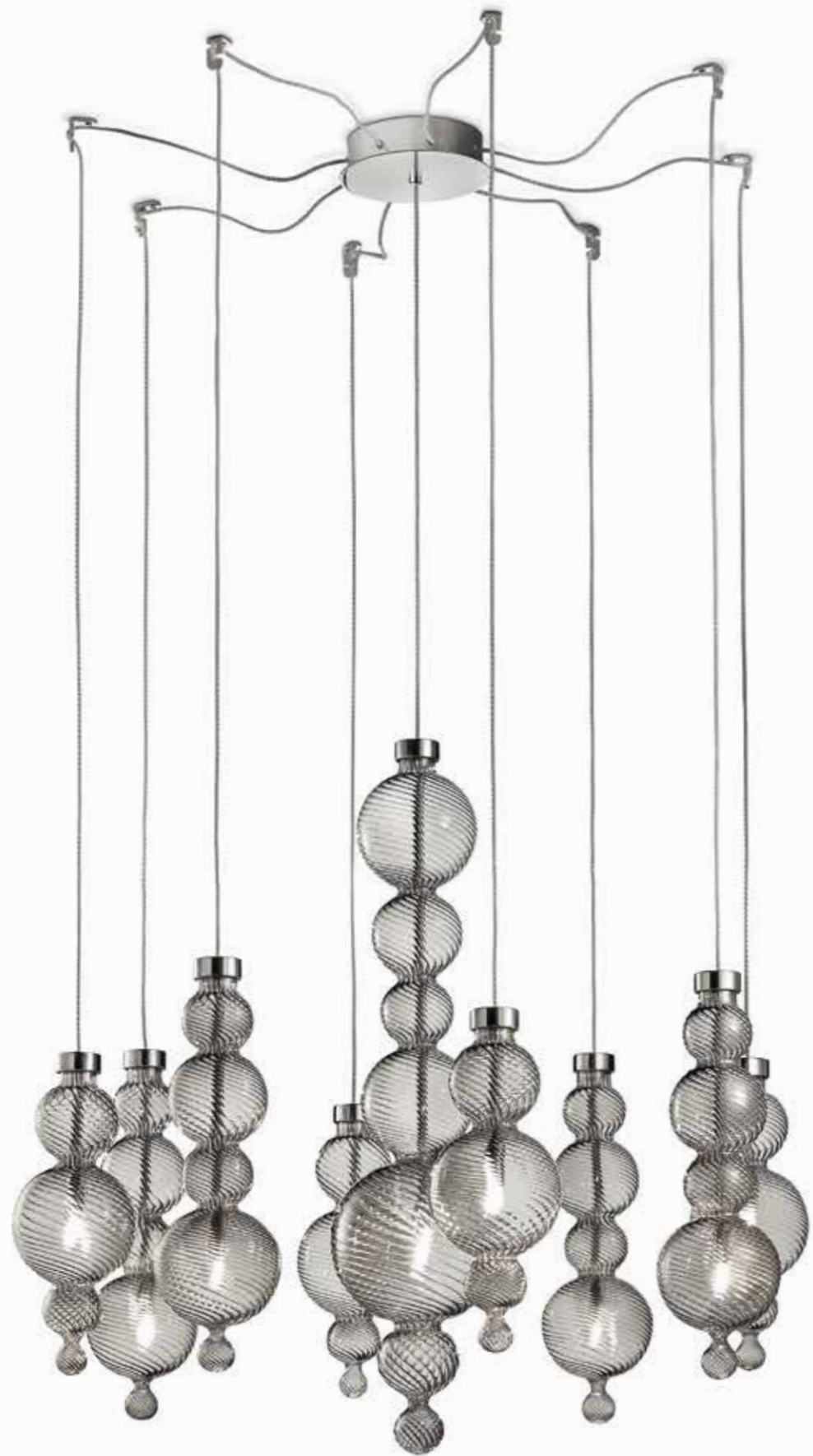

San Marco\_SO 9



San Marco\_SO 9B



San Marco\_PA 1



San Marco\_SO 13B





San Marco\_SO 5B

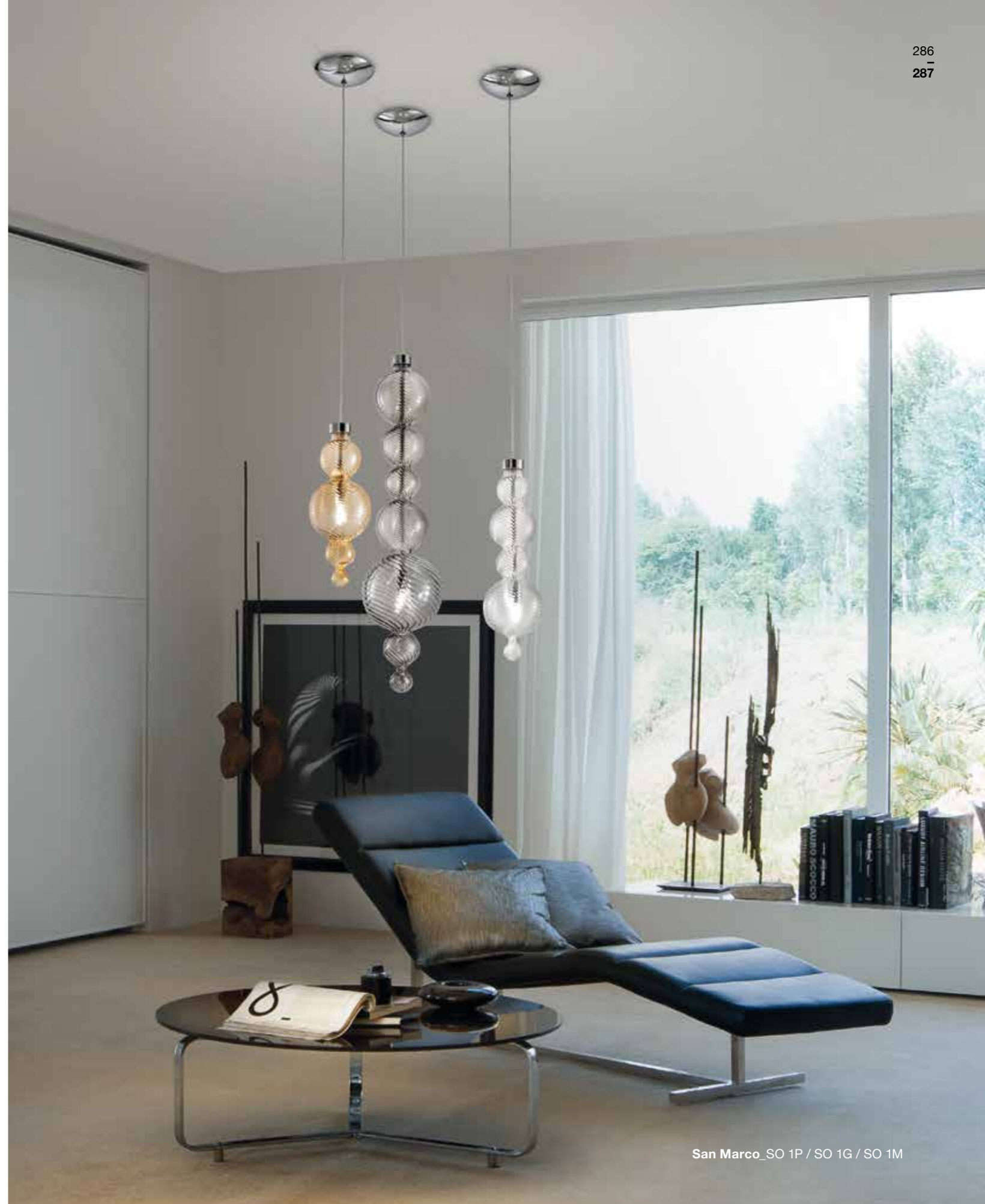

San Marco\_SO 1P / SO 1G / SO 1M



San Marco\_SO 3



San Marco\_ esempio di composizione / example of composition



# SAN MARCO

## \_technical data

Un omaggio a Venezia, alla sua bellezza e alla sua arte vetraria. La collezione di lampade San Marco è una riedizione del classico chandelier Veneziano, qui destrutturato e solo riecheggiato dall'accostamento di semplici globi vitrei di diverso diametro, irrigiditi in successioni modulari con caratteristica goccia pendente. Sono proprio queste concatenazioni lineari a rimandare all'omonima piazza SAN MARCO e alle tondeggianti forme tracciate nello sky-line dalle cupole e dalla facciata della Basilica. La definizione dei 3 modelli base in vetro soffiato "torcion", ciascuno dotato di un proprio punto luce e di una propria sequenza-estensione, permette di allestire infinite composizioni multiple, per un prodotto contemporaneo e di facile personalizzazione.

Un hommage à Venise, à sa beauté et à son art verrier. La collection de lampes San Marco est une réédition du chandelier classique Vénitien, déstructuré ici et évoqué par l'assortiment de simples boules en verre de différents diamètres, raidis en successions modulaires avec le pendentif caractéristique en forme de goutte. Ce sont justement ces enchaînements linéaires qui renvoient à la place SAINT-MARC du même nom et aux formes arrondies tracées dans le sky-line par les coupoles et la façade de la Basilique. La définition des 3 modèles de base en verre soufflé "torcion", muni chacun d'un point lumineux propre et d'une propre séquence-extension, permet d'aménager d'infinies compositions multiples, pour un produit contemporain et facile à personnaliser.

An homage to Venice, to its beauty and the glass-making. The San Marco collection of lamps is a de-structured restyle of the classic Venetian chandelier where simple glass globes of various sizes are matched with a modular arrangement of glass pendants. The aligned arrangements recall the rounded domes and features of the facade of SAINT MARK'S basilica and the square of the same name. The 3 basic models in "torcion" blown glass - each equipped with own bulb and sequence-extension - are easy to customize with an infinite variety of arrangements that let you create your personal contemporary style.

Un homenaje a Venecia, a su belleza y a su arte del vidrio. La colección de lámparas San Marco es una reelaboración de la clásica araña veneciana, que se ha desestructurado para volver a surgir mediante la combinación de simples bolas de cristal de diferentes diámetros, combinadas en sucesiones de módulos con una característica gota colgante. Son exactamente estas concatenaciones lineales las que evocan la homónima plaza SAN MARCO y las formas redondeadas trazadas en la silueta por las cúpulas y fachadas de la Basilica. La definición de los tres modelos básicos de vidrio soplado "torcion", cada uno dotado con un punto de luz y con su secuencia-extension, permite realizar infinitas composiciones múltiples, para un producto contemporáneo y de fácil personalización.

Ein Tribut an die Stadt Venedig, ihre Schönheit und ihre Glaskunst. Die Lampenkollektion San Marco ist eine Neuaufgabe des klassischen venezianischen Kerzenständers, frei strukturiert und in Anordnung einfacher Glaskugeln verschiedener Durchmesser, die hängend als Tropfen angebracht sind. Genau diese Verkettungen sind es, die an den gleichnamigen Platz SAN MARCO und an die rundlichen Formen der Kuppeln und der Fassade der Basilika erinnern. Die Definition der 3 Basismodelle aus geblasenem "Torcion"-Glas, jedes mit einer eigenen Lichtquelle und Sequenz ausgestattet, ermöglicht unzählige und vielfältige Zusammensetzungen für ein modernes und leicht personalisierbares Produkt.

Подарок Венеции, ее красоте и ее стеклудвному искусству. Коллекция светильников San Marco - это переиздание классического Венецианского канделябра, здесь децентрированного и вновь созданного сочетанием простых стеклянных шаров различных диаметров, застывших в модульной последовательности с характеристикой падающей капли. Именно эти линейные сцепления напоминают об одноименной площади SAN MARCO и об округлых формах, чертящих в небе силуэты куполов и фасада Базилики. Представлена тремя базовыми модулями из дутого стекла "torcion", каждый из которых оснащен своим источником света и имеет возможность расширения последовательности, что позволяет создавать бесконечное число композиций с использованием современного и легко персонализированного продукта.

- Struttura:** metallo cromato. **Frame:** chromed metal.
- Diffusore:** vetro soffiato nei colori: ambr, cristallo trasparente e fumè. **Diffuser:** blown glass in these colors: amber, transparent crystal and smoke grey.
- Struktur:** Metall verchromt. **Diffusor:** Geblasenes Glas in den Farben: Bernstein, Kristall transparent und rauchgrau.
- Structure:** métal chrome. **Diffuseur:** verre soufflé dans les coloris ambr, cristal transparent et fumè.
- Estructura:** metal cromado. **Difusor:** vidrio soplado en los colores: ámbar, cristal transparente y ahumado.
- Структура:** хромированный металл. **Рассеиватель:** дутое стекло выполнено в следующих оттенках: янтарь, прозрачный хрусталь и дымчатый.

**SAN MARCO SO 13A**  
13 x MAX 42W G9 alo. ENERGY SAVER o/or  
13 x MAX 3,5W G9 LED ENERGY SAVER  
CE F IP 20 1 EAC

**SAN MARCO SO 13B**  
13 x MAX 42W G9 alo. ENERGY SAVER o/or  
13 x MAX 3,5W G9 LED ENERGY SAVER  
CE F IP 20 1 EAC

**SAN MARCO SO 9**  
9 x MAX 42W G9 alo. ENERGY SAVER o/or  
9 x MAX 3,5W G9 LED ENERGY SAVER  
CE F IP 20 1 EAC

**SAN MARCO SO 7**  
7 x MAX 42W G9 alo. ENERGY SAVER o/or  
7 x MAX 3,5W G9 LED ENERGY SAVER  
CE F IP 20 1 EAC

**SAN MARCO CO**  
1 x MAX 42W G9 alo. ENERGY SAVER o/or  
1 x MAX 3,5W G9 LED ENERGY SAVER  
CE F IP 20 1 EAC

**SAN MARCO SO 1G**  
1 x MAX 42W G9 alo. ENERGY SAVER o/or  
1 x MAX 3,5W G9 LED ENERGY SAVER  
CE F IP 20 1 EAC

**SAN MARCO SO 1M**  
1 x MAX 42W G9 alo. ENERGY SAVER o/or  
1 x MAX 3,5W G9 LED ENERGY SAVER  
CE F IP 20 1 EAC

**SAN MARCO SO 1P**  
1 x MAX 42W G9 alo. ENERGY SAVER o/or  
1 x MAX 3,5W G9 LED ENERGY SAVER  
CE F IP 20 1 EAC

**SAN MARCO SO 3**  
3 x MAX 42W G9 alo. ENERGY SAVER o/or  
3 x MAX 3,5W G9 LED ENERGY SAVER  
CE F IP 20 1 EAC

**SAN MARCO SO 9B**  
9 x MAX 42W G9 alo. ENERGY SAVER o/or  
9 x MAX 3,5W G9 LED ENERGY SAVER  
CE F IP 20 1 EAC

**SAN MARCO SO 5B**  
5 x MAX 42W G9 alo. ENERGY SAVER o/or  
5 x MAX 3,5W G9 LED ENERGY SAVER  
CE F IP 20 1 EAC

**SAN MARCO PA 1**  
1 x MAX 42W G9 alo. ENERGY SAVER o/or  
1 x MAX 3,5W G9 LED ENERGY SAVER  
CE F IP 20 1 EAC

**SAN MARCO SO1G S/R**  
1 x MAX 42W G9 alo. ENERGY SAVER o/or  
1 x MAX 3,5W G9 LED ENERGY SAVER  
CE F IP 20 1 EAC

**SAN MARCO SO1M S/R**  
1 x MAX 42W G9 alo. ENERGY SAVER o/or  
1 x MAX 3,5W G9 LED ENERGY SAVER  
CE F IP 20 1 EAC

**SAN MARCO SO1P S/R**  
1 x MAX 42W G9 alo. ENERGY SAVER o/or  
1 x MAX 3,5W G9 LED ENERGY SAVER  
CE F IP 20 1 EAC

**SAN MARCO CO**  
1 x MAX 42W G9 alo. ENERGY SAVER o/or  
1 x MAX 3,5W G9 LED ENERGY SAVER  
CE F IP 20 1 EAC

**SAN MARCO SO 1G**  
1 x MAX 42W G9 alo. ENERGY SAVER o/or  
1 x MAX 3,5W G9 LED ENERGY SAVER  
CE F IP 20 1 EAC

**SAN MARCO SO 1M**  
1 x MAX 42W G9 alo. ENERGY SAVER o/or  
1 x MAX 3,5W G9 LED ENERGY SAVER  
CE F IP 20 1 EAC

**SAN MARCO SO 1P**  
1 x MAX 42W G9 alo. ENERGY SAVER o/or  
1 x MAX 3,5W G9 LED ENERGY SAVER  
CE F IP 20 1 EAC



# RONDÒ

design\_Andrea Lazzari

Una delicata danza nell'aria.

The charm of round-dancing  
lights.



Rondò\_LA 6



Rondò\_PA2



Rondò\_LA 3

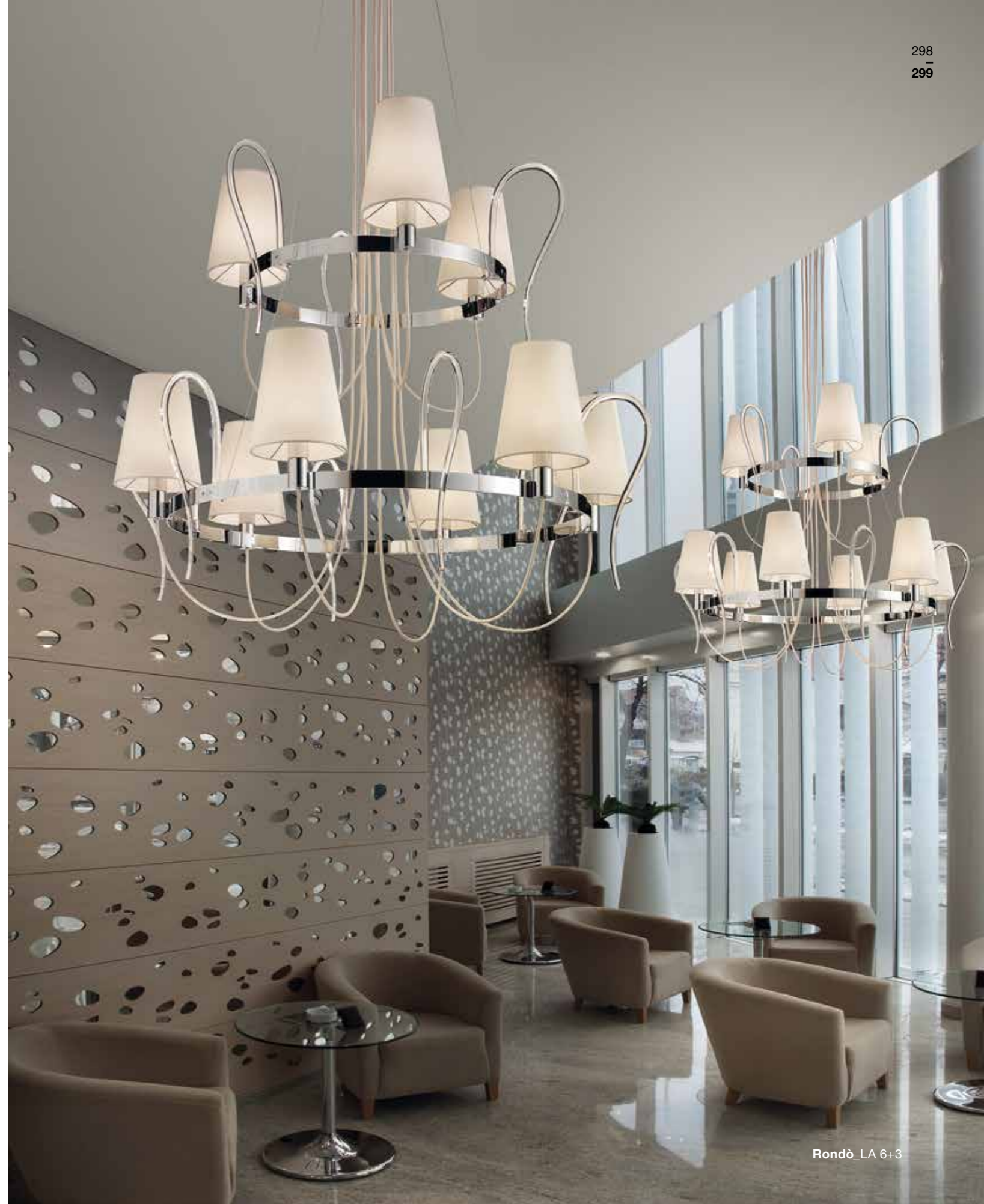

Rondò\_LA 6+3

# RONDÒ

## \_technical data

Nella collezione di lampade Rondò, spicca la delicatezza del vetro di Murano, una scelta che reinterpreta con leggerezza e originalità assoluta il fascino degli storici ma sempre affascinanti lampadari a candele.

Attorno alla struttura in metallo cromato sono distribuiti dei paralumi in tessuto "chinette" abbinati a elementi decorativi in vetro definiti nella tradizione Muranese "pastorali" in diverse colorazioni. Una collezione che unisce passato e presente vestendo della sua forte presenza tutti gli ambienti interni.

La collection de lampes Rondò est dominée par la délicatesse du verre de Murano, un choix qui réinterprète avec une légèreté et une originalité absolues le charme des lustres à bougies historiques mais toujours fascinants.

La structure en métal chromé est entourée d'abat-jour en tissu "chinette" assortis avec des éléments décoratifs en verre définis dans la tradition de Murano comme "pastoraux" dans différentes teintes. Une collection qui unit le passé et le présent en habillant tous les éléments internes de sa forte présence.

The elegance of Murano glass stands out in the Rondò collection of lamps. This choice reinterprets with lightness and absolute originality the charm of the historic but always fascinating candle chandeliers. Around the chromed-plate metal frame the "chinette" fabric lampshades are arranged in a combination with glass decorative elements, called "pastoral" according to the Murano tradition of glass in different colors. The collection sublimely combines past and present and its distinct style is guaranteed to characterize any interior furnishing.

En la colección de lámparas Rondò, sobresa la delicadez del vidrio de Murano, una elección que reinterpreta con ligereza y originalidad absoluta el encanto de las históricas pero siempre fascinantes lucernas.

Alrededor de la estructura en metal cromado están distribuidas unas pantallas en tejido "chinette" combinadas con elementos decorativos en vidrio definidos en la tradición de Murano "pastorales" en varios colores. Una colección que une un pasado y presente cubriendo con su fuerte presencia todos los ambientes internos.

In der Lampenkollektion Rondò sticht die Sanftheit des Murano-Glases hervor, eine Wahl die mit Leichtigkeit und absoluter Originalität die Faszination der historischen, aber weiterhin attraktiven Kerzenleuchter neu interpretiert. Um die verchromte Metallstruktur sind Lampenschirme aus "Chinette"-Stoff kombiniert mit Deko-Elementen aus Glas in verschiedenen Farben angeordnet, die in der Murano-Tradition "pastorali" genannt werden. Diese Kollektion vereint Vergangenheit und Gegenwart und macht sich in jedem Raum durch seine starke Präsenz positiv bemerkbar.

В коллекции светильников Rondò выделяется хрупкость муранского стекла, выбор, который с легкостью и абсолютной оригинальностью вновь интерпретирует очарование исторических, но вечно завораживающих свечеобразных ламп.

Вокруг металлической хромированной структуры расположены абажуры из ткани "chinette", сочетающиеся с декоративными «пасторальными» элементами из муранского стекла различных цветов.

Коллекция объединяет прошлое и настоящее, стильно декорируя своим присутствием любой интерьер.

### Struttura: metallo cromato.

**Vetro:** "pastorali" lavorati a mani nei colori; bianco, nero e cristallo trasparente.

**Diffusore:** paralumi in "chinette" nei colori; avorio, bianco e nero.

### Frame: chromed metal.

**Glass:** handmade "pastorals" in the colors: white, black and transparent crystal.

**Diffuser:** "chinette" lampshades in the colors: ivory, black and white.

### Struktur: Metall verchromt.

**Glas:** Handgemachte "pastorali" in den Farben Weiß, Schwarz und Kristall transparent.

**Diffusor:** Lampenschirme aus "Chinette" in den Farben: Elfenbein, Weiß und Schwarz.

### Structure: métal chrome.

**Verre:** "pastoraux" faits main dans les coloris blanc, noir et cristal transparent.

**Diffuseur:** abat-jour en "chinette" dans les coloris ivoire, blanc et noir.

### Estructura: metal cromado.

**Vidrio:** "pastorales" trabajados a mano en los colores: blanco, negro y cristal transparente.

**Diffusor:** pantallas en "chinette" en los colores; marfil, blanco y negro.

### Структура: хромированный металл.

**Стекло:** «пасторальные» элементы «ручной работы, выполненные в следующих цветах: белый, черный, прозрачный хрусталь.

**Рассеиватель:** абажуры из ткани "chinette" белого, черного цвета или цвета слоновой кости.



BI: Bianco/White



AV: Avorio/Ivory



NO: Nero/Black

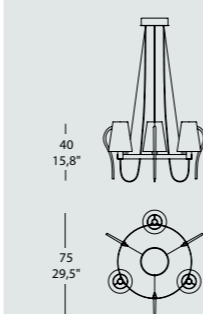

### RONDÒ LA 3

3 x MAX 42W E14 alo. ENERGY SAVER  
o/or

3 x MAX 6W E14 LED

CE F IP20 1 EAC

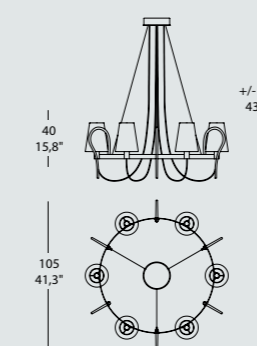

### RONDÒ LA 6

6 x MAX 42W E14 alo. ENERGY SAVER  
o/or

6 x MAX 6W E14 LED

CE F IP20 1 EAC

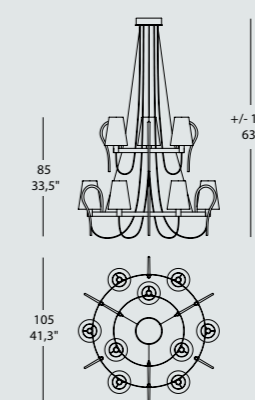

### RONDÒ LA 6+3

9 x MAX 42W E14 alo. ENERGY SAVER  
o/or

9 x MAX 6W E14 LED

CE F IP20 1 EAC

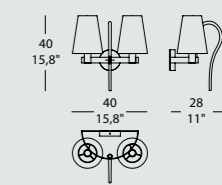

### RONDÒ PA 2

2 x MAX 42W E14 alo. ENERGY SAVER  
o/or

2 x MAX 6W E14 LED

CE F IP20 1 EAC



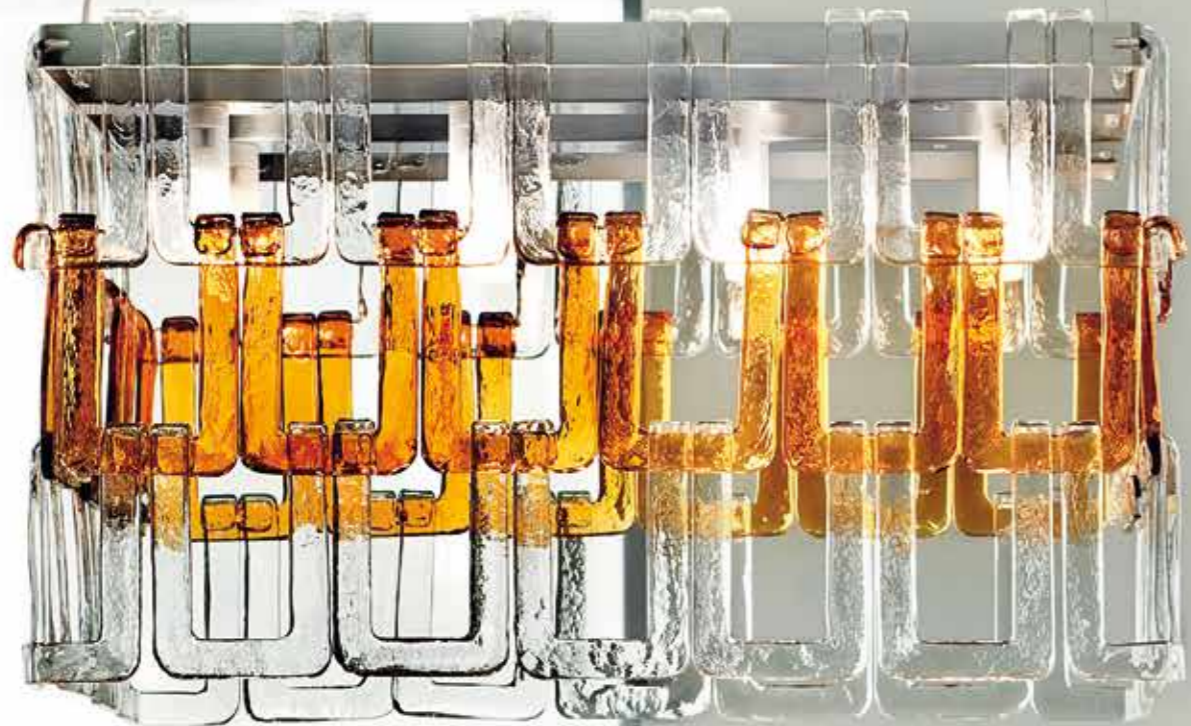

# TESSUTI

design\_Simone Bellan

Trasparenze e colori  
orditi nel vetro.

Transparencies and colours  
interweaved in the glass.



Tessuti\_SO 30 maxi\_Monocromatico/Monochromatic



Tessuti\_SO 90 mini\_Monocromatico/Monochromatic



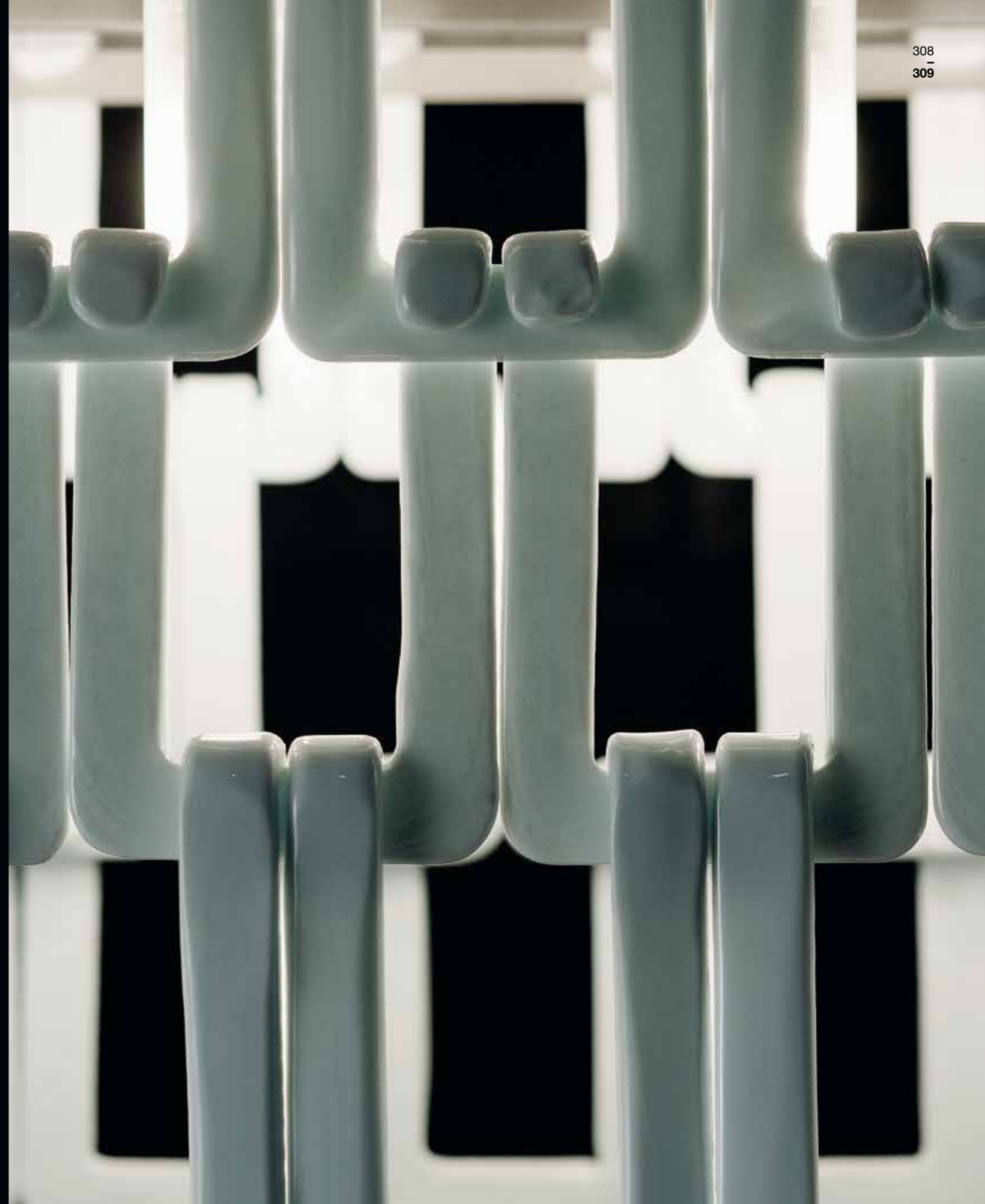
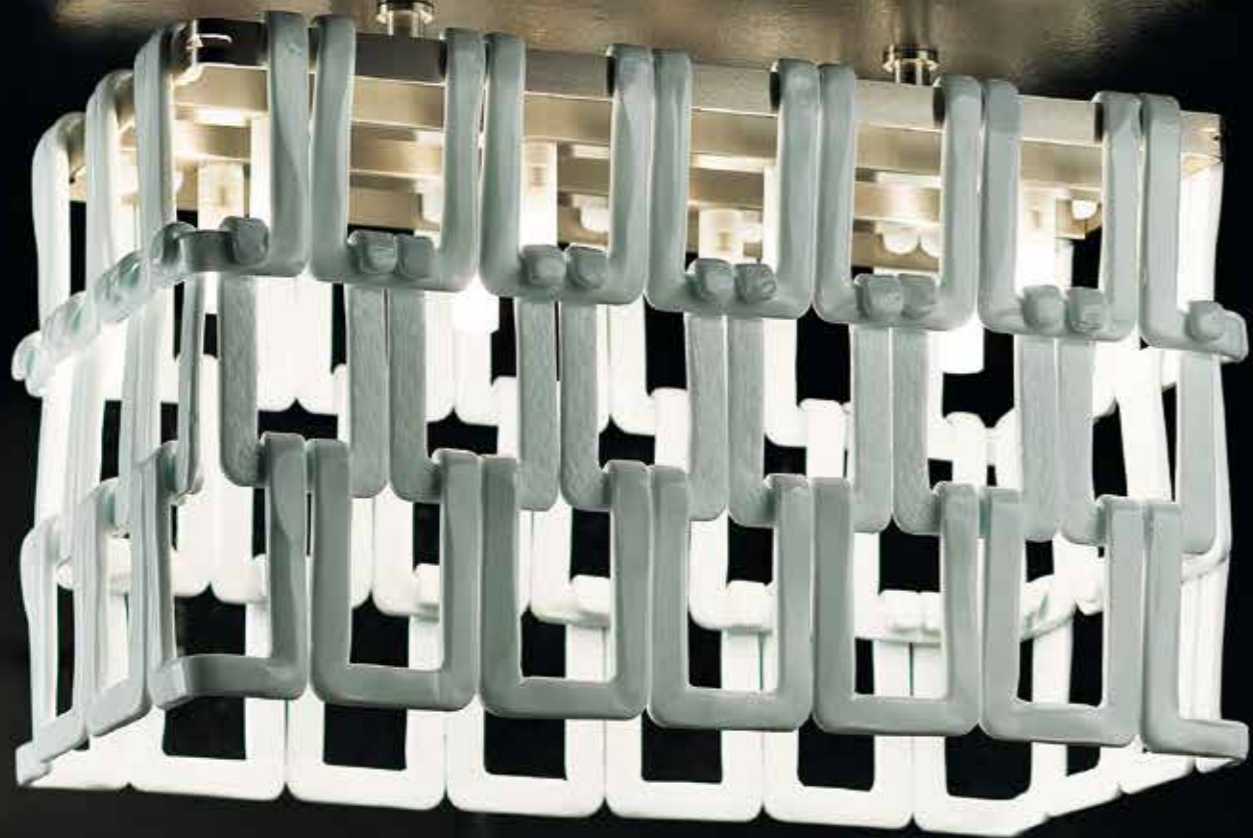



## TESSUTI

\_technical data

Solo una storia di artigianato antica di migliaia di anni può arrivare a produrre un risultato così innovativo. La tradizione del vetro di Murano rivive nella collezione Tessuti. Una serie di ganci in vetro lavorato a mano tessono una tela dalla forza materica, che gioca con la percezione e colpisce lo sguardo per la sua magnificenza. La collezione è disponibile in più colori, anche abbinabili, e ogni installazione è componibile a piacere su strutture metalliche standard o su richieste specifiche del cliente. Tessuti è il frutto del lavoro di esperti vetrai e dello stile unico di Evi Style. Dedicato all'arredamento più ricercato, sia domestico che contract.

Seule une histoire d'artisanat vieille de milliers d'années peut produire un résultat aussi innovant. La tradition du verre de Murano revit à travers la collection Tessuti. Une série de crochets en verre faits main tisse une toile d'une force matiériste, qui joue avec la perception et frappe le regard par sa magnificence. La collection est disponible en plusieurs teintes, qu'il est possible d'assortir, et chaque installation est composable à volonté sur des structures métalliques standards ou à partir de demandes spécifiques du client. Tessuti est le fruit du travail de maîtres verriers et du style unique d'Evi Style. Dédié à la décoration la plus raffinée, résidentielle et collective.

**Struttura:** metallo nichel satinato.

**Diffusore:** vetro lavorato a mano nelle colorazioni: cristallo trasparente, fumé, ambra e bianco lucido.

**Frame:** metal nickel satinized.

**Diffuser:** handmade glass in these colors: transparent crystal, smoke-grey, amber and white polished finish.

**Struktur:** Metall nickelsatiniert.

**Diffusor:** Handgemachtes Glas in den Farben: Bernstein, Glanzweiß, Kristall transparent und rauchig.

**Structure:** métal nickel satiné.

**Diffuseur:** verre façonné à la main dans les coloris cristal transparent, fumé, ambre et blanc brillant.

**Estructura:** metal níquel satinado.

**Difusor:** vidrio trabajado a mano en los colores: cristal transparente, ahumado, ámbar y blanco brillante.

**Структура:** металл сатинированный никель.

**Рассеиватель:** стекло ручной работы доступное в следующих цветах: прозрачный хрусталь, дымчатый, янтарный и белый блестящий.

## Esempi di possibili combinazioni SOSPENSIONE – PLAFONIERA / Examples of possible combinations SUSPENSION – CEILING

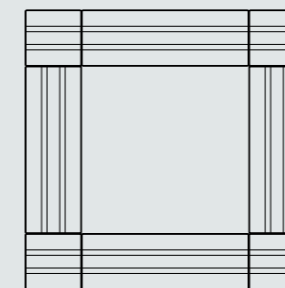

**150 x 150 cm** dimensione struttura  
59" x 59" frame dimension

**159 x 159 cm** dimensione struttura con vetri  
62,6" x 62,6" overall dimension with glasses

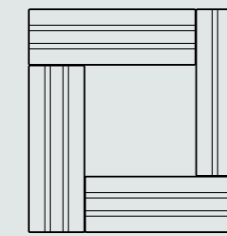

**120 x 120 cm** dimensione struttura  
47,2" x 47,2" frame dimension

**128 x 128 cm** dimensione struttura con vetri  
50,4" x 50,4" overall dimension with glasses

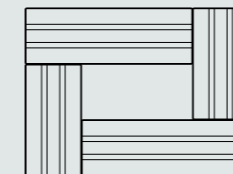

**120 x 90 cm** dimensione struttura  
47,2" x 35,4" frame dimension

**128 x 97 cm** dimensione struttura con vetri  
50,4" x 38,2" overall dimension with glasses

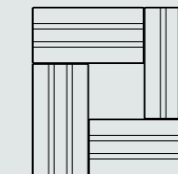

**90 x 90 cm** dimensione struttura  
35,4" x 35,4" frame dimension

**97 x 97 cm** dimensione struttura con vetri  
38,2" x 38,2" overall dimension with glasses

Misure standard/Standard measures



**30 x 30 cm** - 11,8" x 11,8"  
**35 x 35 cm** - 13,8" x 13,8"



**60 x 30 cm** - 23,6" x 11,8"  
**66 x 35 cm** - 26" x 13,8"



**90 x 30 cm** - 35,4" x 11,8"  
**97 x 35 cm** - 38,2" x 13,8"

dimensione struttura - frame dimension  
dimensione struttura con vetri  
overall dimension with glasses

Esempi di possibili combinazioni SOSPENSIONE – PLAFONIERA / Examples of possible combinations SUSPENSION – CEILING



**300 x 30 cm** - 118,10" x 11,8" dimensione struttura - frame dimension  
**312 x 35 cm** - 122,8" x 13,8" dimensione struttura con vetri  
overall dimension with glasses

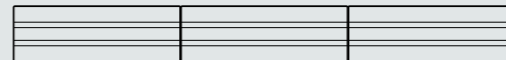

**270 x 30 cm** - 106,3" x 11,8" dimensione struttura - frame dimension  
**281 x 35 cm** - 110,6" x 13,8" dimensione struttura con vetri  
overall dimension with glasses

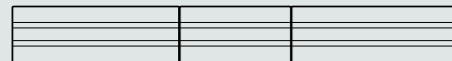

**240 x 30 cm** - 94,5" x 11,8" dimensione struttura - frame dimension  
**251 x 35 cm** - 98,8" x 13,8" dimensione struttura con vetri  
overall dimension with glasses



**210 x 30 cm** - 82,7" x 11,8" dimensione struttura - frame dimension  
**220 x 35 cm** - 86,6" x 13,8" dimensione struttura con vetri  
overall dimension with glasses



**180 x 30 cm** - 70,9" x 11,8" dimensione struttura - frame dimension  
**189 x 35 cm** - 74,4" x 13,8" dimensione struttura con vetri  
overall dimension with glasses



**150 x 30 cm** - 59" x 11,8" dimensione struttura - frame dimension  
**159 x 35 cm** - 62,6" x 13,8" dimensione struttura con vetri  
overall dimension with glasses



**120 x 30 cm** - 47,2" x 11,8" dimensione struttura - frame dimension  
**128 x 35 cm** - 50,4" x 13,8" dimensione struttura con vetri  
overall dimension with glasses

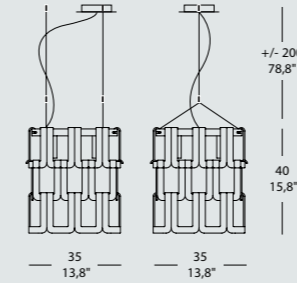

**TESSUTI SO 30 MINI**

4 x MAX 42W G9 alo. ENERGY SAVER  
o/or  
4 x MAX 3,5W G9 LED ENERGY SAVER  
CE F IP 20 1 EAC

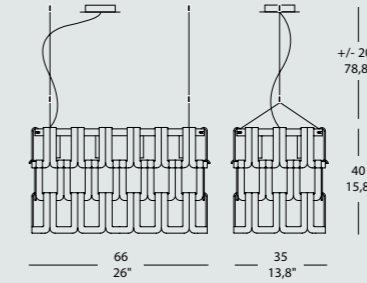
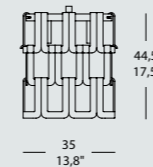

**TESSUTI SO 60 MINI**

8 x MAX 42W G9 alo. ENERGY SAVER  
o/or  
8 x MAX 3,5W G9 LED ENERGY SAVER  
CE F IP 20 1 EAC

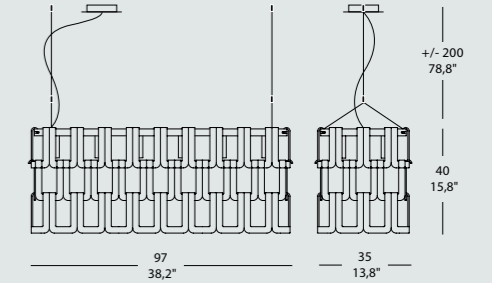
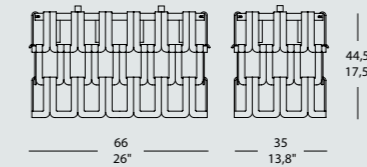

**TESSUTI SO 90 MINI**

12 x MAX 42W G9 alo. ENERGY SAVER  
o/or  
12 x MAX 3,5W G9 LED ENERGY SAVER  
CE F IP 20 1 EAC

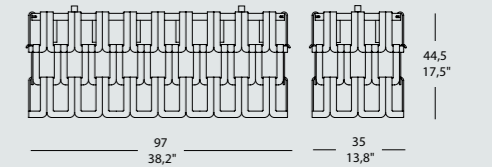

**TESSUTI PL 30 MINI**

4 x MAX 42W G9 alo. ENERGY SAVER  
o/or  
4 x MAX 3,5W G9 LED ENERGY SAVER  
CE F IP 20 1 EAC

**TESSUTI PL 60 MINI**

8 x MAX 42W G9 alo. ENERGY SAVER  
o/or  
8 x MAX 3,5W G9 LED ENERGY SAVER  
CE F IP 20 1 EAC

**TESSUTI PL 90 MINI**

12 x MAX 42W G9 alo. ENERGY SAVER  
o/or  
12 x MAX 3,5W G9 LED ENERGY SAVER  
CE F IP 20 1 EAC

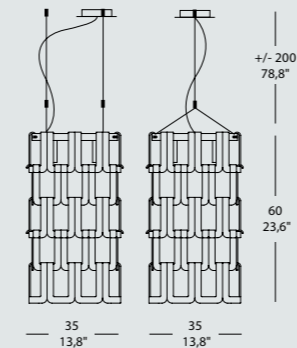

**TESSUTI SO 30 MAXI**

4 x MAX 42W G9 alo. ENERGY SAVER  
o/or  
4 x MAX 3,5W G9 LED ENERGY SAVER  
CE F IP 20 1 EAC

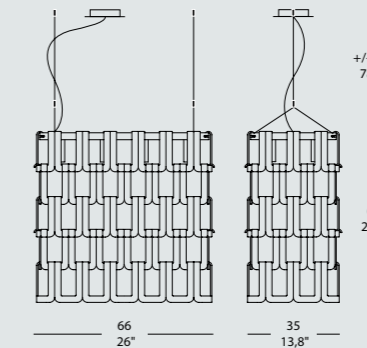

**TESSUTI SO 60 MAXI**

8 x MAX 42W G9 alo. ENERGY SAVER  
o/or  
8 x MAX 3,5W G9 LED ENERGY SAVER  
CE F IP 20 1 EAC

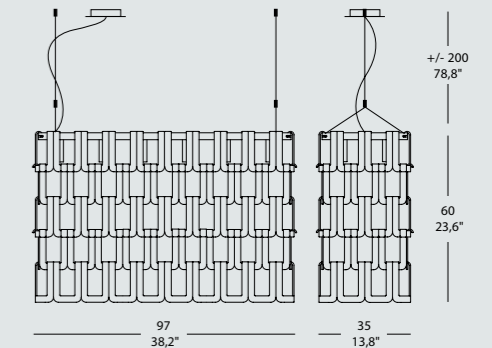

**TESSUTI SO 90 MAXI**

12 x MAX 42W G9 alo. ENERGY SAVER  
o/or  
12 x MAX 3,5W G9 LED ENERGY SAVER  
CE F IP 20 1 EAC

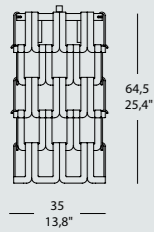

**TESSUTI PL 30 MAXI**

4 x MAX 42W G9 alo. ENERGY SAVER  
0/or  
4 x MAX 3,5W G9 LED

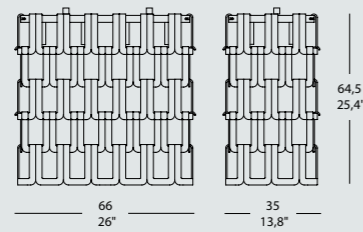
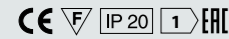

**TESSUTI PL 60 MAXI**

8 x MAX 42W G9 alo. ENERGY SAVER  
0/or  
8 x MAX 3,5W G9 LED

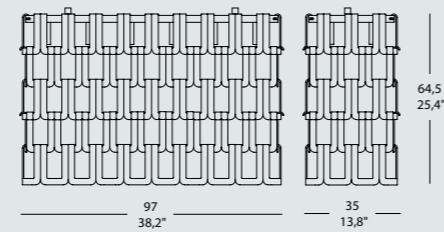
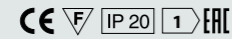

**TESSUTI PL 90 MAXI**

12 x MAX 42W G9 alo. ENERGY SAVER  
0/or  
12 x MAX 3,5W G9 LED

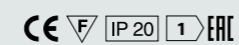

**SOSPENSIONE, PLAFONIERA  
SUSPENSION, CEILING**

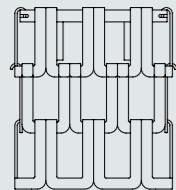

35 x 35 x h40 cm  
13,8" x 13,8" x h15,8"

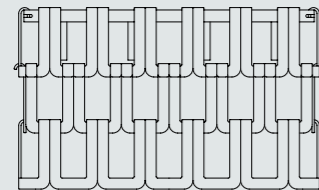

66 x 35 x h40 cm  
26" x 13,8" x h15,8"

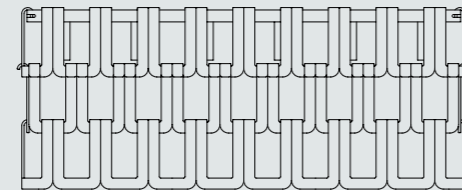

97 x 35 x h40 cm  
38,2" x 13,8" x h15,8"

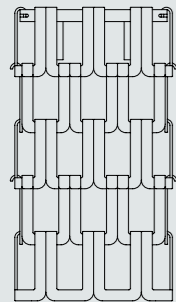

35 x 35 x h60 cm  
13,8" x 13,8" x h23,6"

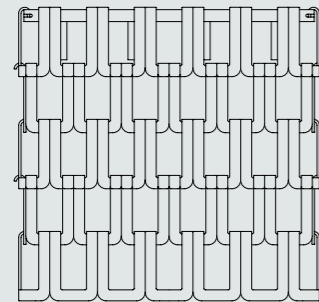

66 x 35 x h60 cm  
26" x 13,8" x h23,6"

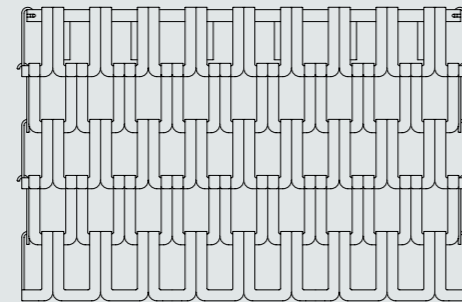

97 x 35 x h60 cm  
38,2" x 13,8" x h23,6"

**MONOCROMATICO: CRISTALLO, AMBRA, FUMÉ, BIANCO  
MONOCHROMATIC: CRYSTAL, AMBER, SMOKE-GREY, WHITE**

**SOSPENSIONE, PLAFONIERA  
SUSPENSION, CEILING**

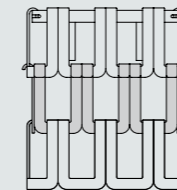

35 x 35 x h40 cm  
13,8" x 13,8" x h15,8"

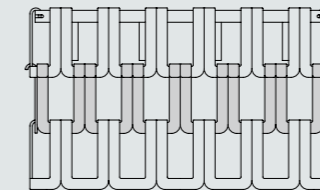

66 x 35 x h40 cm  
26" x 13,8" x h15,8"

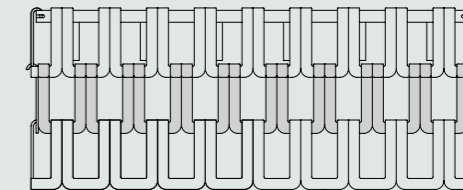

97 x 35 x h40 cm  
38,2" x 13,8" x h15,8"

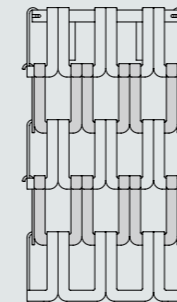

35 x 35 x h60 cm  
13,8" x 13,8" x h23,6"

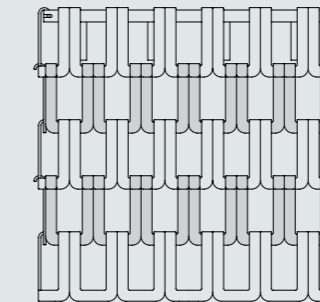

66 x 35 x h60 cm  
26" x 13,8" x h23,6"

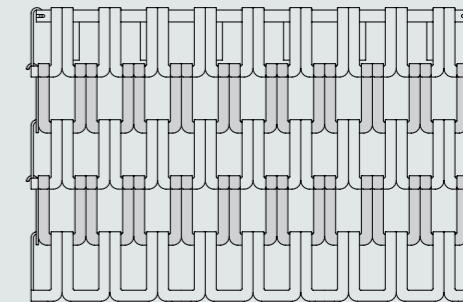

97 x 35 x h60 cm  
38,2" x 13,8" x h23,6"

**SOSPENSIONE, PLAFONIERA  
SUSPENSION, CEILING**

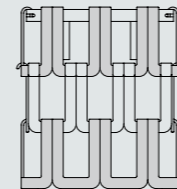

35 x 35 x h40 cm  
13,8" x 13,8" x h15,8"

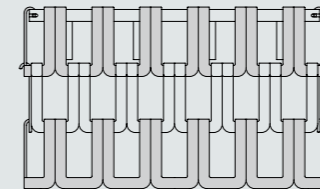

66 x 35 x h40 cm  
26" x 13,8" x h15,8"

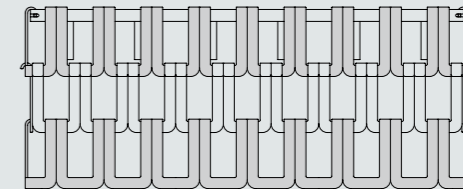

97 x 35 x h40 cm  
38,2" x 13,8" x h15,8"

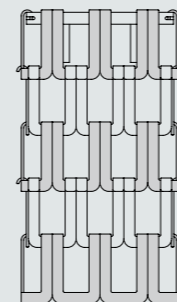

35 x 35 x h60 cm  
13,8" x 13,8" x h23,6"

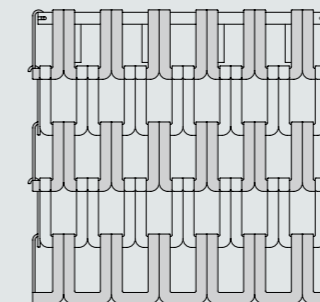

66 x 35 x h60 cm  
26" x 13,8" x h23,6"

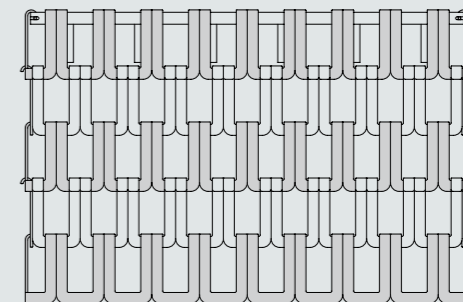

97 x 35 x h60 cm  
38,2" x 13,8" x h23,6"

**BICROMATICO A: CRISTALLO/AMBRA, CRISTALLO/FUMÉ  
BICOLOUR A: CRYSTAL/AMBER, CRYSTAL/SMOKE-GREY**

**BICROMATICO B: AMBRA/CRISTALLO, FUMÉ/CRISTALLO  
BICOLOUR B: AMBER/CRYSTAL, SMOKE-GREY/CRYSTAL**



# LEGENDA



Tutte le lampade sono costruite secondo le norme europee EN 60598-1 e con materiali approvati da vari istituti di sicurezza.  
All the lamps are made according to European standards EN 60598-1 and of materials approved by various safety institutes.



Apparecchio predisposto per il montaggio su superfici infiammabili.  
Fixture ready for mounting on inflammable surfaces.



Apparecchio in classe II - Apparecchio nel quale la protezione contro la scossa elettrica non si basa unicamente sull'isolamento fondamentale, ma anche sulle misure supplementari di sicurezza costituite dal doppio isolamento o dall'isolamento rinforzato. Queste misure non comportano dispositivi per la messa a terra e non dipendono dalle condizioni d'installazione.

Class II appliance - appliance in which protection against electric shock is not only based on basic insulation, but also on additional safety measures, i.e. double insulation or reinforced insulation. These measures do not involve earthing devices and do not depend on the installation conditions.









Grado di protezione - Stabilisce un sistema per la classificazione degli apparecchi elettrici in base al grado di protezione fornito dagli involucri degli stessi.

I simboli utilizzati per indicare questo grado di protezione sono costituiti dalle lettere "IP" seguite da due cifre caratteristiche:  
- la prima cifra indica la protezione contro la penetrazione dei corpi solidi e della polvere;  
- la seconda cifra indica la protezione contro la penetrazione dei liquidi.

Protection level - This establishes a classification system for electric appliances based on the protection level supplied by their casing.  
The symbols used to indicate the level of protection are the two letters, "IP" followed by two figures.  
- The first figure indicates the protection against penetration by solid bodies and dust;  
- The second figure indicates the protection against penetration by liquids.

## Gradi di protezione IP - Protection degrees (IP)

1ª cifra protezione alla penetrazione di corpi solidi. 1st figure: protection against penetration by solid bodies.		2ª cifra protezione contro la penetrazione d'acqua. 2nd figure: protection against penetration by water.	
0	Non Protetto. No protection.	0	Non Protetto. No protection.
1	Protetto da corpi solidi superiori a 50 mm. Protected against solid matters (over 50 mm.).	1	Protetto contro lo stillicidio. Protected proof fixture. 
2	Protetto da corpi solidi superiori a 12 mm. Protected against solid matters (over 12 mm.).	2	Protetto da cadute d'acqua, inclinazione di 15. Protected against water falling at 15 angle.
3	Protetto da corpi solidi superiori a 2,5 mm. Protected against solid matters (over 2,5 mm.).	3	Protetto contro la pioggia. Rain proof fixture. 
4	Protetto da corpi solidi superiori a 1 mm. Protected against solid matters (over 1 mm.).	4	Protetto contro gli spruzzi. Splash proof fixture. 
5	Protetto contro la polvere. Dust proof. 	5	Protetto contro getti d'acqua. Water jet proof. 
6	Totalmente protetto contro la polvere. Fully dust. 	6	Protetto contro le ondate. Wave proof.



Articoli con moduli LED: consumo ridotto, lunga durata.  
Articles with LED modules: low consumption, long life.



Dimmerabile Triac.  
Triac dimmable.



Articoli con moduli LED Dim to Warm:  
consumo ridotto, lunga durata.  
Articles with Dim to Warm LED modules:  
low consumption, long life.



Dimmerabile.  
Dimmable.

## ETICHETTE ENERGETICHE DI PRODOTTO - PRODUCT ENERGY LABELS ENERGIE-EFFIZIENZETIKETTEN DES PRODUKT - ÉTIQUETTE D'ENERGIE DU PRODUIT ETIQUETAS ENERGÉTICAS DE PRODUCTO - ЭНЕРГЕТИЧЕСКАЯ МАРКИРОВКА ПРОДУКЦИИ.

Indicano la classe di efficienza energetica delle sorgenti luminose compatibili con l'apparecchio d'illuminazione.  
Indicate the class of Energy-efficiency of light sources compatible with the lighting device.  
Zeigen die Klasse der Energie-Effizienz der mit dem Beleuchtungsgerät kompatiblen Lichtquellen an.  
Montrent la classe du rendement d'énergie des sources lumineuses compatibles avec l'appareil d'illumination.  
Indican la clase de eficiencia energética de los surgentes luminosos compatibles con el aparato de iluminación.  
указывают класс энергетической эффективности источников света совместимых с осветительным устройством.



Questo dispositivo è compatibile con lampadine di classi energetiche:  
Diese Leuchte ist geeignet für Leuchtmittel der Energieklassen:  
This luminaire is compatible with bulbs of the energy classes:  
Ce luminaire est compatible avec des ampoules des classes énergétiques:  
Esta luminaria es compatible con bombillas de las clases energéticas:  
Этот прибор совместим с лампочками следующих классов энергетической эффективности:

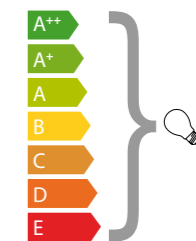

Questo dispositivo è compatibile con lampadine di classi energetiche:  
Diese Leuchte ist geeignet für Leuchtmittel der Energieklassen:  
This luminaire is compatible with bulbs of the energy classes:  
Ce luminaire est compatible avec des ampoules des classes énergétiques:  
Esta luminaria es compatible con bombillas de las clases energéticas:  
Этот прибор совместим с лампочками следующих классов энергетической эффективности:

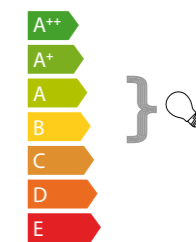

Questo dispositivo è munito di lampade a LED integrate.  
Le lampade di questo dispositivo non sono sostituibili.

This luminaire contains built-in LED lamps.  
The lamps cannot be changed in the luminaire.

Diese Leuchte enthält eingebaute LED-Lampen.  
Die Lampen können in der Leuchte nicht ausgetauscht werden.

Ce luminaire comporte des lampes à LED intégrées.  
Les lampes de ce luminaire ne peuvent pas être changées.

Esta luminaria lleva lámparas LED incorporadas.  
Las lámparas de esta luminaria no son recambiables.

Этот прибор снабжен встроенным LED источником.  
Лампочки этого прибора не подлежат замене.

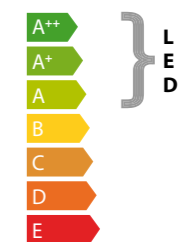

Certificazione di conformità valida per l'unione doganale EurAsEC.  
Certification for Eurasian Customs Union.  
Zertifizierung nach der europäischen Norm für die Eurasische Wirtschaftsgemeinschaft.  
Certificat de conformité pour la Union douanière Eurasienne.  
Certificado de conformidad con validez para la Unión Euroasiática.  
сертификация соответствия действительна для таможенного союза ЕврАзЭС



---

Associato/Associate

---



Distributor for  
U.S.A.

**MEDIALIGHT**  
— Lighting+Design —

1971 NE 148 ST.  
NORTH MIAMI  
FL 33141  
t. 305.919.0286 f. 305.394.8739

[www.medialightusa.com](http://www.medialightusa.com)  
[info@medialightusa.com](mailto:info@medialightusa.com)

**MOROSINI**

t. +39 041 5952772  
f. +39 041 5956175  
info@luciitaliane.com  
www.morosinisrl.com

**EVI STYLE** Passion for Light

t. +39 041 5951544  
f. +39 041 5956175  
info@luciitaliane.com  
www.evistyle.com

---

Brands of **Luci Italiane** srl  
via delle Industrie, 70  
30020 Marcon (VE) - Italy