

A personal
living
experience

C—05

saba™

A personal
living
experience

C—05

saba™

Che cosa fa un divano oltre alla sua funzione primaria, ovvero far sedere le persone?

it — A un primo sguardo, un divano è un oggetto semplice: una scatola di legno o di ferro cui si aggiungono dei cuscini. Abbiamo quindi sentito l'urgenza di interrogare l'oggetto divano, cogliendone le doti di flessibilità e atemporalità. Individuarle per amplificarle. Espandere la struttura nelle sue parti centrali per poi scoprire che il divano, più che un oggetto, è un luogo d'inclusione e di condivisione. Del resto, l'etimologia stessa della parola ne racchiude il senso profondo: il divano è "il luogo in cui si prendono le decisioni importanti". Quando s'interroga qualcosa o qualcuno, ci si aspetta una reazione. Un fare, che però non deve essere né banale, né complicato. Deve essere immediato come un gesto e avere una finalità.

Ecco nascere un divano che cambia con grazia, modellandosi sulle esigenze ergonomiche di ognuno di noi e, fedele a se stesso, muta insieme al mutare della vita. È l'arte di adattarsi a ogni tempo e a ogni spazio. E siccome fare bene è forse meglio di fare tanto, abbiamo sublimato questi principi in progetti che ci permettessero di esprimere un'eleganza ineffabile e obliqua. Una linea curva e flessibile, una forma morbida che attraversa lo spazio del living e allarga lo sguardo verso altri territori: la stanza da letto e gli esterni, cui si aggiungono dei piccoli accessori a completamento.

Infine, fuggendo da imperativi categorici su come debba essere un ambiente per poter accogliere un nostro prodotto, abbiamo immaginato una pluralità di case. Quattro nuclei abitativi possibili che rivelano storie diverse, tutte valide, tutte personali. Ve le raccontiamo in questo catalogo, che è anche un progetto filosofico, un manifesto dell'abitare e del farsi abitare. Il divano non si accontenta del suo status di mero oggetto estetico ma diventa la risposta a un bisogno. Una risposta migliorativa alla qualità della vita dei singoli, e insieme trasversale nel pubblico cui si rivolge. Perché – inutile dirlo – il vero protagonista di questo viaggio non è il luogo divano ma le persone che lo vivono.

Amelia Pegorin

What more can a sofa do other than its primary function of seating people?

en — At first glance, a sofa is a simple object: a wood or iron box onto which pillows are adjusted. We therefore felt the urge to question the very object that is the sofa, with its qualities of flexibility and timelessness. Identify these, to then amplify them. Expanding the structure within its central parts to then discover that the sofa is not just an object, but a place of inclusion and sharing. After all, the etymology of the word encloses its profound meaning: "the sofa is the place from which important decisions are taken". When interrogating something or someone, a reaction is expected. An action that however cannot be neither banal, nor complicated. It has to be immediate like a gesture and have a purpose.

Here a sofa is born, which changes with grace, modelling itself upon everybody's ergonomic requirements and, faithful to itself, transforms alongside life's transformations. It is the art of adaptation to any time and place. Since doing well is probably better than doing loads, we have elevated these principles into objects that would allow us to express an indescribable and oblique elegance. A curved and flexible line, a soft form that crosses the living area and broadens our gaze towards other territories: the bedroom and the outdoor as well as other small accessories.

Lastly, fleeing from categorical imperatives that dictate how a space should be to welcome one of our products, we have imagined a plurality of homes. Four inhabited nuclei that narrate different stories, all valid, all personal. We illustrate them in this catalogue, which also represents a philosophical project, a manifesto of living and being lived. The sofa does not settle for its status as a mere aesthetic object, but becomes an answer to a specific need. An improved answer to anyone's quality of life, and transversal to the public it addresses. Because – needless to say – the real protagonist in this journey is not the sofa itself but the people who experience it.

Amelia Pegorin

Que fait un canapé, en plus de remplir sa fonction primaire qui consiste à offrir aux individus un endroit où s'asseoir ?

fr — À première vue, un canapé est un objet simple : une structure en bois ou en fer à laquelle on a ajouté des coussins. Nous avons donc ressenti l'urgence d'interroger l'objet canapé, en saisissant ses propriétés de flexibilité et d'atemporalité. Les identifier pour les amplifier. Étendre la structure dans ses parties centrales pour ensuite découvrir que le canapé, plus qu'un objet, est un lieu d'intégration et de partage. Du reste, l'étymologie même du mot divan, synonyme de canapé, en renferme le sens profond : le divan est « le lieu où l'on prend les décisions importantes ». Lorsque l'on interroge quelque chose ou quelqu'un, on s'attend à une réaction. Une chose qui ne doit cependant être ni banale ni compliquée. Elle doit être immédiate comme un geste et avoir une finalité.

Voici comment naît un canapé qui change avec grâce, se façonnant en fonction des exigences ergonomiques de chacun d'entre nous et qui, fidèle à lui-même, évolue en fonction des évolutions de la vie. C'est l'art de s'adapter à tous les instants et à tous les espaces. Et puisque faire bien est peut-être mieux que faire beaucoup, nous avons sublimé ces principes dans des projets en mesure d'exprimer une élégance ineffable et transversale. Une ligne incurvée et flexible, une forme douce qui traverse l'espace du séjour et élargit le regard vers d'autres territoires : la chambre à coucher et les extérieurs, auxquels s'ajoutent de petits accessoires venant les compléter.

Enfin, nous éloignant d'impératifs formels sur comment un espace devrait être pour pouvoir accueillir l'un de nos produits, nous avons imaginé une pluralité de maisons. Quatre noyaux d'habitation possibles qui révèlent des histoires différentes, toutes valables, toutes personnelles. Nous vous les racontons dans ce catalogue, qui est également un projet philosophique, un manifeste sur la manière d'habiter et d'être habité. Le canapé ne se contente pas de son statut de simple objet esthétique mais devient la réponse à un besoin. Une réponse qui améliore la qualité de vie des différents individus et qui occupe également une place transversale dans le public auquel elle s'adresse. Parce que - il est inutile de le dire - le véritable protagoniste de ce travail n'est pas le divan en tant que lieu mais les personnes qui le vivent.

Amelia Pegorin

Para qué sirve un sofá además de desempeñar su función principal, es decir, permitir que las personas se sienten?

es — A primera vista, un sofá es un objeto sencillo: un armazón de madera o hierro al que se le añaden cojines. Por eso, hemos sentido la exigencia de cuestionar el concepto de sofá, tomando en consideración propiedades tales como la flexibilidad y la intemporalidad. Determinarlas para amplificarlas. Expandir la estructura en sus partes centrales para luego descubrir que el sofá, más que un objeto, es un lugar de inclusión y compartición. Después de todo, la etimología de la palabra misma entraña su profundo significado: el sofá es "el lugar donde se toman las decisiones importantes". Cuando se cuestiona algo o alguien, se espera una reacción. Un hecho, sin embargo, que no debe ser trivial ni complicado. Como gesto debe ser inmediato y tener una finalidad.

De ahí que nace un sofá que cambia con gracia, adaptándose a las exigencias ergonómicas de cada uno de nosotros y, fiel a sí mismo, evoluciona al mismo tiempo que la vida. Es el arte de adaptarse a cada momento y a cada espacio. Y como hacer las cosas bien es tal vez mejor que hacer mucho, hemos sublimado estos principios en proyectos que nos permitieran expresar una elegancia inefable y oblicua. Una línea curva y flexible, una forma suave que atraviesa el espacio del salón y amplía la vista hacia otros territorios: el dormitorio y los exteriores, a los que se añaden pequeños accesorios como toque final.

Finalmente, escapando de los imperativos categóricos sobre cómo debe ser un ambiente para poder acoger a uno de nuestros productos, hemos imaginado una variedad de casas. Cuatro posibles viviendas que revelan historias distintas, todas válidas, todas personales. Les hablamos de ellas en este catálogo, que es también un proyecto filosófico, un manifiesto del concepto de vivir y ser vivido. El sofá no se conforma con su estatus de mero objeto estético, sino que se convierte en la respuesta a una necesidad. Una respuesta que mejora la calidad de vida de los individuos, y al mismo tiempo, transversal en el público al que se dirige. Porque - no hace falta decirlo - el verdadero protagonista de este viaje no es el sofá como lugar, sino las personas que lo viven.

Amelia Pegorin

Index

Sofas

Chairs & Stools

- 010 ● Pixel
- 030 New York Suite
- 046 ● My Taos
- 060 ● Avant-Après
- 076 ● Ananta Class
- 096 ● Limes New
- 108 Voyage
- 118 Up
- 126 Essentiel
- 138 ● Rendez-vous
- 154 Les Femmes
- 160 Livingston
- 168 Geo
- 172 Philo
- 178 Kepi
- 182 New York Dining
- 186 Quinta Strada
- 194 Karma

Armchairs & Poufs

- 202 No Logo Light
- 208 New York Armchair
- 208 New York Bergère
- 214 Geo
- 214 Baby Geo
- 222 Chance
- 226 Chillout
- 230 Amélie
- 234 Bustier
- 238 Essentiel
- 238 Baby Essentiel
- 244 Kepi
- 250 Philo
- 254 Valentine
- 256 Livingston
- 258 Sitar
- 264 Ola
- 268 Geo Pouf
- 270 Island
- 272 Cookie
- 276 Pixel Pouf
- 278 Honey

- 282 New York Chair
- 282 New York Dining
- 282 New York Stool
- 294 New York Chair by Marras
- 300 Ola Chair
- 300 Ola Stool
- 308 Isabelle Chair
- 308 Isabelle Stool

Beds & Sofa Beds

- 314 Pixel Box Large
- 314 Pixel Box
- 324 Pixel Air
- 330 New York Air
- 330 New York Box
- 338 Limes Large
- 338 Limes
- 338 Limes T Large
- 348 Avant-Après
- 356 Bed & Breakfast

Low Tables & Furniture

- 366 Hexa
- 370 Hexa Consolle
- 372 Haiku
- 376 Leyva
- 382 Ring Table
- 386 Ziggy
- 390 Più Table
- 392 Shade

Outdoor

- 396 New York Soleil
- 410 Garden Table
- 412 Shades of Venice
- 416 Ziggy
- 420 Geo Pouf Outdoor
- 424 New York Outdoor
- 428 Grace

● Modular System Sofas

— All products are available for Contract Solutions

Sofas



- 010 ● Pixel
- 030 New York Suite
- 046 ● My Taos
- 060 ● Avant-Après
- 076 ● Ananta Class
- 096 ● Limes New
- 108 Voyage
- 118 Up
- 126 Essentiel
- 138 ● Rendez-vous
- 154 Les Femmes
- 160 Livingston
- 168 Geo
- 172 Philo
- 178 Kepi
- 182 New York Dining
- 186 Quinta Strada
- 194 Karma

● *Modular System Sofas*

design Sergio Bicego
production year 2010
restyling 2014

technical data
p. 434

Pixel



010

011

Composizione 446×204 cm
in tessuto Creta col.2A
Tavolino Hexa
Tavolino Più
Poltroncina Amélie

Composition 446×204 cm
in fabric Creta col.2A
Hexa low table
Più low table
Amélie small armchair

Composition 446×204 cm
en tissu Creta col.2A
Table basse Hexa
Table basse Più
Petit fauteuil Amélie

Composición 446×204 cm
de tela Creta col.2A
Mesa de centro Hexa
Mesa de centro Più
Pequeño sillón Amélie





Composizione 446x204 cm
in tessuto Creta col.2A

Composition 446x204 cm
in fabric Creta col.2A

Composition 446x204 cm
en tissu Creta col.2A

Composiçón 446x204 cm
de tela Creta col.2A



Composizione 366x162 cm
in tessuto Creta col.2A
Tavolino Hexa
Tavolini Più

Composition 366x162 cm
in fabric Creta col.2A
Hexa low table
Più low tables

Composition 366x162 cm
en tissu Creta col.2A
Table basse Hexa
Tables basses Più

Composición 366x162 cm
de tela Creta col.2A
Mesa de centro Hexa
Mesas de centro Più



Composizione 294x132 cm
in tessuto Patchwork
(Creta col.2A / Darwin col.07 /
Teddy col.01/1 / Avant-Après col.56)
Tavolino Hexa
Poltroncina Ola
Pouf Geo

Composition 294x132 cm
in Patchwork fabric
(Creta col.2A / Darwin col.07 /
Teddy col.01/1 / Avant-Après col.56)
Hexa low table
Ola small armchair
Geo pouf

Composition 294x132 cm
en tissu Patchwork
(Creta col.2A / Darwin col.07 /
Teddy col.01/1 / Avant-Après col.56)
Table basse Hexa
Petit fauteuil Ola
Pouf Geo

Composición 294x132 cm
de tela Patchwork
(Creta col.2A / Darwin col.07 /
Teddy col.01/1 / Avant-Après col.56)
Mesa de centro Hexa
Pequeño sillón Ola
Puf Geo





020

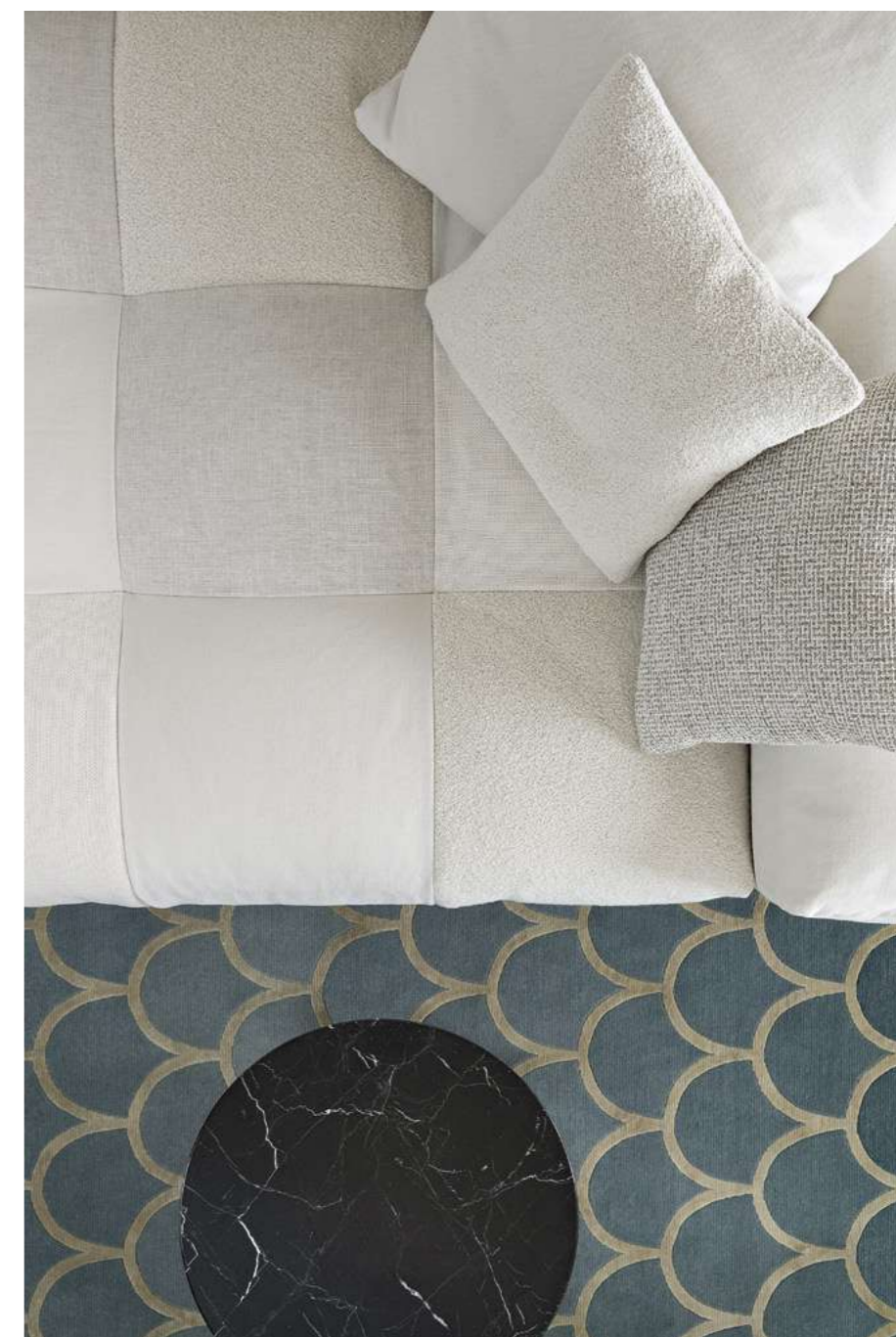

Composizione 294×132 cm
in tessuto Patchwork
(Creta col.2A / Darwin col.07 /
Teddy col.01/1 / Avant-Après col.56)
Tavolino Hexa
Poltroncina Ola

Composition 294×132 cm
in Patchwork fabric
(Creta col.2A / Darwin col.07 /
Teddy col.01/1 / Avant-Après col.56)
Hexa low table
Ola small armchair

Composition 294×132 cm
en tissu Patchwork
(Creta col.2A / Darwin col.07 /
Teddy col.01/1 / Avant-Après col.56)
Table basse Hexa
Petit fauteuil Ola

Composición 294×132 cm
de tela Patchwork
(Creta col.2A / Darwin col.07 /
Teddy col.01/1 / Avant-Après col.56)
Mesa de centro Hexa
Pequeño sillón Ola

021

Composizione 418x264 cm
in tessuto F555 col.03
Tavolini Più
Tavolino e consolle Hexa
Pouf Geo

Composition 418x264 cm
in fabric F555 col.03
Più low tables
Hexa low table and console
Geo pouf

Composition 418x264 cm
en tissu F555 col.03
Tables basses Più
Table basse et console Hexa
Pouf Geo

Composición 418x264 cm
de tela F555 col.03
Mesas de centro Più
Mesa de centro y consola Hexa
Puf Geo





Composizione 418x264 cm
in tessuto F555 col.03
Tavolino Più
Tavolino Hexa

Composition 418x264 cm
in fabric F555 col.03
Più low table
Hexa low table

Composition 418x264 cm
en tissu F555 col.03
Table basse Più
Table basse Hexa

Composició 418x264 cm
de tela F555 col.03
Mesa de centro Più
Mesa de centro Hexa



Composizione 244x122 cm
in tessuto Creta col.2A

Composition 244x122 cm
en tissu Creta col.2A

Composition 244x122 cm
in fabric Creta col.2A

Composición 244x122 cm
de tela Creta col.2A



026

406 x 122 cm Composizione / Composition A

Elementi / Elements: 2 Basi / Bases 122x82 cm
 1 Base / Base 122x122 cm
 3 Schienali-Braccioli / Back-Arm rests 122 cm H 64 cm
 2 Cuscini schiena / Back cushions 66x66 cm
 1 Cuscino arredo / Throw cushion 45x45 cm



306 x 132 cm Composizione / Composition B

Elementi / Elements: 1 Base / Base 82x82 cm
 2 Basi / Bases 122x82 cm
 3 Schienali / Backrests 82 cm
 1 Schienale / Backrest 122 cm
 2 Cuscini schiena / Back cushions 66x66 cm
 1 Cuscino arredo / Throw cushion 45x45 cm



027

296 x 254 cm **Composizione / Composition C**

- Elementi / Elements:
- 1 Base / Base 164x82 cm
 - 2 Basi / Bases 122x122 cm
 - 3 Schienali / Backrests 82 cm
 - 2 Cuscini schiena / Back cushions 66x66 cm
 - 1 Cuscino arredo / Throw cushion 45x45 cm
 - 1 Rullo / Roll 23 cm



284 x 256 cm **Composizione / Composition D**

- Elementi / Elements:
- 2 Basi / Bases 122x82 cm
 - 1 Base / Base 164x82 cm
 - 1 Schienale / Backrest 82 cm
 - 1 Schienale / Backrest 122 cm
 - 1 Schienale-Bracciolo / Back-Arm rest 82 cm H 52 cm
 - 1 Schienale-Bracciolo / Back-Arm rest 164 cm H 52 cm
 - 2 Cuscini schiena / Back cushions 66x66 cm
 - 1 Cuscino schiena 66x66 cm con rullo 12 cm / Back cushion 66x66 cm with roll 12 cm
 - 3 Cuscini arredo / Throw cushions 45x45 cm



Composizione 284x284 cm
in tessuto Creta col.2A

Composition 284x284 cm
en tissu Creta col.2A

Composition 284x284 cm
in fabric Creta col.2A

Composición 284x284 cm
de tela Creta col.2A



design Sergio Bicego
production year 2015

technical data
p. 438

New York Suite





Divani 190×100 cm
e 230×100 cm
in tessuto Lario col.1101
Tavolini Hexa
Tavolino Ring

Sofas 190×100 cm
and 230×100 cm
in fabric Lario col.1101
Hexa low tables
Ring low table

Canapés 190×100 cm
et 230×100 cm
en tissu Lario col.1101
Tables basses Hexa
Table basse Ring

Sofás 190×100 cm
y 230×100 cm
de tela Lario col.1101
Mesas de centro Hexa
Mesa de centro Ring

Divani 230×100 cm
in tessuto Lario col.1101
Tavolini Hexa
Tavolino Ring

Sofas 230×100 cm
in fabric Lario col.1101
Hexa low tables
Ring low table

Canapés 230×100 cm
en tissu Lario col.1101
Tables basses Hexa
Table basse Ring

Sofás 230×100 cm
de tela Lario col.1101
Mesas de centro Hexa
Mesa de centro Ring





036

Divano 230×100 cm
in tessuto Lario col.1101
Tavolini Hexa

Sofa 230×100 cm
in fabric Lario col.1101
Hexa low tables



Canapé 230×100 cm
en tissu Lario col.1101
Tables basses Hexa

Sofá 230×100 cm
de tela Lario col.1101
Mesas de centro Hexa

037





Composizione 335x165 cm
in tessuto Sweet Velvet col.62
Tavolini Più
Consolle Hexa

Composition 335x165 cm
in fabric Sweet Velvet col.62
Più low tables
Hexa console

Composition 335x165 cm
en tissu Sweet Velvet col.62
Tables basses Più
Console Hexa

Composició 335x165 cm
de tela Sweet Velvet col.62
Mesas de centro Più
Consola Hexa





Divano 230×100 cm
e pouf 140×65 cm
in tessuto Lario col.1403
Tavolino Haiku

Sofa 230×100 cm
and pouf 140×65 cm
in fabric Lario col.1403
Haiku low table



Canapé 230×100 cm
et pouf 140×65 cm
en tissu Lario col.1403
Table basse Haiku

Sofá 230×100 cm
y puf 140×65 cm
de tela Lario col.1403
Mesa de centro Haiku



Poltrona lounge 155x130 cm
in tessuto Teddy col.05/6
Tavolino Hexa

Lounge armchair 155x130 cm
in fabric Teddy col.05/6
Hexa low table

Fauteuil lounge 155x130 cm
en tissu Teddy col.05/6
Table basse Hexa

Sillón lounge 155x130 cm
de tela Teddy col.05/6
Mesa de centro Hexa

design Sergio Bicego
production year 1999
restyling 2018

technical data
p. 441

My Taos



Composizione 446x210 cm
in tessuto Dickinson col.14
Tavolino in noce
canaletto 105x28 cm
Tavolini Più

Composition 446x210 cm
in fabric Dickinson col.14
Low table in walnut
veneer 105x28 cm
Più low tables

Composition 446x210 cm
en tissu Dickinson col.14
Table basse en bois
de noyer 105x28 cm
Tables basses Più

Composición 446x210 cm
de tela Dickinson col.14
Mesa de centro de nogal
canaletto 105x28 cm
Mesas de centro Più



Composizione 389x160 cm
e base 130x130 cm
in tessuto Tundra 01 col.03
Tavolini Più
Tavolini e librerie Leyva

Composition 389x160 cm
and base 130x130 cm
in fabric Tundra 01 col.03
Più low tables
Leyva low tables and bookcases

Composition 389x160 cm
et base 130x130 cm
en tissu Tundra 01 col.03
Tables basses Più
Tables basses et bibliothèques
Leyva

Composición 389x160 cm
y base 130x130 cm
de tela Tundra 01 col.03
Mesas de centro Più
Mesas de centro y librerías
Leyva

Divano 260x130 cm
in tessuto Avant-Après col.24
Tavolino Più
Tavolino Leyva

Sofa 260x130 cm
in fabric Avant-Après col.24
Più low table
Leyva low table

Canapé 260x130 cm
en tissu Avant-Après col.24
Table basse Più
Table basse Leyva

Sofá 260x130 cm
de tela Avant-Après col.24
Mesa de centro Più
Mesa de centro Leyva



Composizione 366x260 cm
in tessuto Seventy col.90
Tavolino in noce
canaletto 105x28 cm
Tavolini Più

Composition 366x260 cm
in fabric Seventy col.90
Low table in walnut
veneer 105x28 cm
Più low table

Composition 366x260 cm
en tissu Seventy col.90
Table basse en bois
de noyer 105x28 cm
Table basse Più

Composición 366x260 cm
de tela Seventy col.90
Mesa de centro de nogal
canaletto 105x28 cm
Mesa de centro Più





411 x 130 cm **Composizione / Composition A**

- Elementi / Elements:
- 1 Base / Base 130x130 cm
 - 1 Centrale / Central unit 85x105 cm
 - 1 Centrale / Central unit 170x105 cm
 - 1 Bracciolo DX / Right armrest 26 cm
 - 1 Cuscino schiena / Back cushion 85 cm
 - 1 Rullo / Roll 23 cm



341 x 341 cm **Composizione / Composition B**

- Elementi / Elements:
- 1 Base / Base 210x105 cm
 - 1 Centrale / Central unit 105x105 cm
 - 1 Centrale / Central unit 210x105 cm
 - 1 Bracciolo SX / Left armrest 26 cm
 - 1 Bracciolo DX / Right armrest 26 cm
 - 1 Cuscino schiena / Back cushion 85 cm
 - 1 Rullo / Roll 23 cm



Note / Notes: La seduta degli elementi centrali può **scorrere** in avanti / Central unit seating can **slide** forward

326 x 130 cm **Composizione / Composition C**

- Elementi / Elements:
- 1 Base / Base 130x130 cm
 - 1 Centrale / Central unit 170x105 cm
 - 1 Bracciolo DX / Right armrest 26 cm
 - 1 Cuscino schiena / Back cushion 85 cm
 - 1 Rullo / Roll 23 cm
 - 1 Tavolino / Low table 105x28 cm



Note / Notes: La seduta degli elementi centrali può **scorrere** in avanti / Central unit seating can **slide** forward





design Sergio Bicego
production year 2017

technical data
p. 444

Avant-Après

Composizione 356x253 cm
in tessuto Avant-Après col.18
Tavolino in noce
canaletto 35x38 cm
Poltroncina Baby Geo
Tavolino Ring
Tavolino Haiku

Composizione 356x253 cm
in fabric Avant-Après col.18
Low table in walnut
veneer 35x38 cm
Baby Geo small armchair
Ring low table
Haiku low table

Composition 356x253 cm
en tissu Avant-Après col.18
Table basse en bois
de noyer 35x38 cm
Petit fauteuil Baby Geo
Table basse Ring
Table basse Haiku

Composición 356x253 cm
de tela Avant-Après col.18
Mesa de centro de nogal
canaletto 35x38 cm
Pequeño sillón Baby Geo
Mesa de centro Ring
Mesa de centro Haiku





Composizione 356×253 cm
in tessuto Avant-Après col.18
Tavolino in noce
canaletto 35×38 cm

Composition 356×253 cm
in fabric Avant-Après col.18
Low table in walnut
veneer 35×38 cm

Composition 356×253 cm
en tissu Avant-Après col.18
Table basse en bois
de noyer 35×38 cm

Composición 356×253 cm
de tela Avant-Après col.18
Mesa de centro de
nogal canaletto 35×38 cm



Composizione 346x93 cm
in tessuto Avant-Après col.18
Tavolino in noce
canaletto 70x33 cm
Tavolino Ring

Composition 346x93 cm
in fabric Avant-Après col.18
Low table in walnut
veneer 70x33 cm
Ring low table

Composition 346x93 cm
en tissu Avant-Après col.18
Table basse en bois
de noyer 70x33 cm
Table basse Ring

Composición 346x93 cm
de tela Avant-Après col.18
Mesa de centro de nogal
canaletto 70x33 cm
Mesa de centro Ring





Composizione 346×93 cm
in tessuto Avant-Après col.18
Tavolino in noce
canaletto 35×38 cm

Composition 346×93 cm
en tissu Avant-Après col.18
Table basse en bois
de noyer 35×38 cm

Composition 346×93 cm
in fabric Avant-Après col.18
Low table in walnut
veneer 35×38 cm

Composición 346×93 cm
de tela Avant-Après col.18
Mesa de centro de nogal
canaletto 35×38 cm



Divano 236×93 cm
in tessuto
Avant-Après col.02
Tavolino in noce
canaletto 35×38 cm
Tavolino Haiku
Pouf Geo

Sofa 236×93 cm
in fabric
Avant-Après col.02
Low table in walnut
veneer 35×38 cm
Haiku low table
Geo pouf

Canapé 236×93 cm
en tissu
Avant-Après col.02
Table basse en bois
de noyer 35×38 cm
Table basse Haiku
Pouf Geo

Sofá 236×93 cm
de tela
Avant-Après col.02
Mesa de centro de nogal
canaletto 35×38 cm
Mesa de centro Haiku
Puf Geo

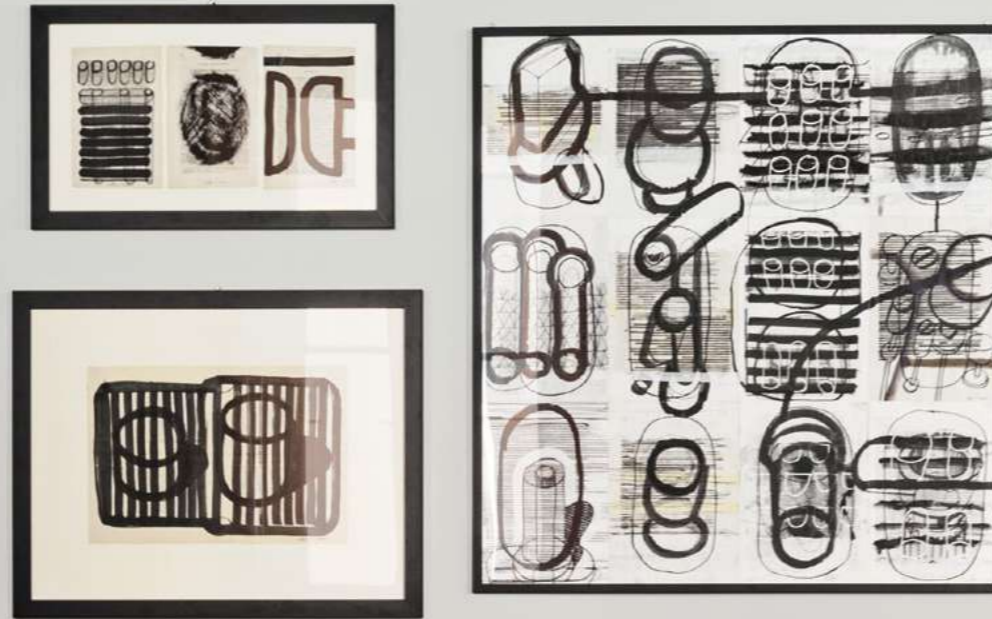



Composizione 346x93 cm
in tessuto Avant-Après col.18
Tavolini in noce canaletto
70x33 cm e 35x38 cm
Pouf Geo

Composition 346x93 cm
en tissu Avant-Après col.18
Tables basses en bois de noyer
70x33 cm et 35x38 cm
Pouf Geo

Composition 346x93 cm
in fabric Avant-Après col.18
Low tables in walnut veneer
70x33 cm and 35x38 cm
Geo pouf

Composición 346x93 cm
de tela Avant-Après col.18
Mesas de centro de nogal canaletto
70x33 cm y 35x38 cm
Puf Geo

293 x 236 cm Composizione / Composition A

Elementi / Elements:
2 Basi / Bases 200x80 cm
5 Schienali / Backrests 80 cm
1 Bracciolo / Armrest
1 Cuscino schiena / Back cushion 62 cm
4 Cuscini schiena / Back cushions 80 cm
1 Cuscino bracciolo / Armrest cushion
1 Tavolino / Low table 35x38 cm



293 x 236 cm Composizione / Composition B

Elementi / Elements:
1 Base / Base 200x80 cm
1 Base con bracciolo imbottito / Base with padded armrest 200x80 cm
5 Schienali / Backrests 80 cm
1 Bracciolo / Armrest
1 Cuscino schiena / Back cushion 62 cm
4 Cuscini schiena / Back cushions 80 cm
1 Cuscino bracciolo / Armrest cushion
1 Tavolino / Low table 35x38 cm



316 x 106 cm **Composizione / Composition C**

- Elementi / Elements:
- 1 Base / Base 120x80 cm
 - 1 Base / Base 160x80 cm
 - 3 Schienali / Backrests 80 cm
 - 1 Bracciolo / Armrest
 - 1 Cuscino schiena / Back cushion 62 cm
 - 2 Cuscini schiena / Back cushions 80 cm
 - 1 Cuscino bracciolo / Armrest cushion
 - 1 Tavolino / Low table 35x38 cm





design Sergio Bicego
production year 2000
restyling 2016

technical data
p. 447

Ananta Class

Composizione 346×103 cm
in tessuto Plain col.01
Poltrona Kepi
Tavolino Più
Tavolino Ring
Pouf Geo

Composition 346×103 cm
in fabric Plain col.01
Kepi armchair
Più low table,
Ring low table
Geo pouf

Composition 346×103 cm
en tissu Plain col.01
Fauteuil Kepi
Table basse Più
Table basse Ring
Pouf Geo

Composició 346×103 cm
de tela Plain col.01
Sillón Kepi
Mesa de centro Più
Mesa de centro Ring
Puf Geo



Composizione 346×103 cm
in tessuto Plain col.01
Poltrona Kepi
Tavolino Più
Tavolino Ring

Composition 346×103 cm
in fabric Plain col.01
Kepi armchair
Più low table
Ring low table

Composition 346×103 cm
en tissu Plain col.01
Fauteuil Kepi
Table basse Più
Table basse Ring

Composición 346×103 cm
de tela Plain col.01
Sillón Kepi
Mesa de centro Più
Mesa de centro Ring



Composizione 346×183 cm
in tessuto Plain col.01
Tavolini in cuoio
80×35 cm e 50×35 cm
Tavolino Hexa
Pouf Cookie

Composition 346×183 cm
en tissu Plain col.01
Tables basses en cuir
80×35 cm et 50×35 cm
Table basse Hexa
Pouf Cookie

Composition 346×183 cm
in fabric Plain col.01
Low tables in leather
80×35 cm and 50×35 cm
Hexa low table
Cookie pouf

Composición 346×183 cm
de tela Plain col.01
Mesas de centros de cuero
80×35 cm y 50×35 cm
Mesa de centro Hexa
Puf Cookie



Composizione 346×183 cm
in tessuto Plain col.01
Tavolino Hexa

Composition 346×183 cm
in fabric Plain col.01
Hexa low table

Composition 346×183 cm
en tissu Plain col.01
Table basse Hexa

Composición 346×183 cm
de tela Plain col.01
Mesa de centro Hexa



Composizione 366x223 cm
in tessuto Creta col.94

Composition 366x223 cm
en tissu Creta col.94

Composition 366x223 cm
in fabric Creta col.94

Composiçión 366x223 cm
de tela Creta col.94



Composizione 326×263 cm
in tessuto Flo col.02
Tavolini in cuoio
80×35 cm e 50×35 cm
Tavolini Più
Poltrona Bustier

Composition 326×263 cm
in fabric Flo col.02
Low tables in leather
80×35 cm and 50×35 cm
Più low tables
Bustier armchair

Composition 326×263 cm
en tissu Flo col.02
Tables basses en cuir
80×35 cm et 50×35 cm
Tables basses Più
Fauteuil Bustier

Composición 326×263 cm
de tela Flo col.02
Mesas de centro de cuero
80×35 cm y 50×35 cm
Mesas de centro Più
Sillón Bustier



Composizione 366x303 cm
in tessuto Gaucho col.16
Pouf 80x80 cm
in pelle Natural col. Nut
Tavolini in noce canaletto
80x35 cm e 50x35 cm

Composition 366x303 cm
in fabric Gaucho col.16
Pouf 80x80 cm
in leather Natural col. Nut
Low tables in walnut veneer
80x35 cm and 50x35 cm

Composition 366x303 cm
en tissu Gaucho col.16
Pouf 80x80 cm
en cuir Natural col. Nut
Tables basses en bois de noyer
80x35 cm et 50x35 cm

Composición 366x303 cm
de tela Gaucho col.16
Puf 80x80 cm
de piel Natural col. Nut
Mesas de centro de nogal canaletto
80x35 cm y 50x35 cm



090

091

Composizione 366x303 cm
in tessuto Gaucho col.16
Pouf 80x80 cm
in pelle Natural col. Nut
Tavolini in noce canaletto
80x35 cm e 50x35 cm
New York Bergère

Composition 366x303 cm
in fabric Gaucho col.16
Pouf 80x80 cm
in leather Natural col. Nut
Low tables in walnut veneer
80x35 cm and 50x35 cm
New York Bergère

Composition 366x303 cm
en tissu Gaucho col.16
Pouf 80x80 cm
en cuir Natural col. Nut
Tables basses en bois de noyer
80x35 cm et 50x35 cm
New York Bergère

Composición 366x303 cm
de tela Gaucho col.16
Puf 80x80 cm
de piel Natural col. Nut
Mesas de centro de nogal canaletto
80x35 cm y 50x35 cm
New York Bergère



Composizione / Composition A

- Elementi / Elements:
- 1 Base / Base 160x80 cm
 - 1 Base / Base 200x80 cm
 - 1 Schienale / Backrest 80 cm
 - 1 Schienale / Backrest 120 cm
 - 2 Schienali angolari / Corner backrests 103x103 cm
 - 3 Cuscini schiena con rullo / Back cushions with roll 75 cm
 - 1 Tavolino / Low table 50x35 cm



326 x 183 cm Composizione / Composition B

- Elementi / Elements:
- 1 Base / Base 160x80 cm
 - 1 Base / Base 200x80 cm
 - 1 Schienale / Backrest 80 cm
 - 1 Schienale / Backrest 120 cm
 - 2 Schienali angolari / Corner backrests 103x103 cm
 - 3 Cuscini schiena con rullo / Back cushions with roll 75 cm
 - 1 Tavolino / Low table 50x35 cm



286 x 246 cm **Composizione / Composition C**

- Elementi / Elements:
- 1 Base / Base 160x80 cm
 - 1 Base / Base 200x80 cm
 - 1 Schienale / Backrest 80 cm
 - 1 Schienale / Backrest 120 cm
 - 2 Schienali angolari / Corner backrests 103x103 cm
 - 3 Cuscini schiena con rullo / Back cushions with roll 75 cm
 - 1 Tavolino / Low table 50x35 cm



Composizione / Composition D
Divani / Sofas 246 x 103 cm - 183 x 103 cm

- Elementi / Elements:
- 1 Base / Base 160x80 cm
 - 1 Base / Base 200x80 cm
 - 1 Schienale / Backrest 80 cm
 - 1 Schienale / Backrest 120 cm
 - 2 Schienali angolari / Corner backrests 103x103 cm
 - 3 Cuscini schiena con rullo / Back cushions with roll 75 cm
 - 1 Tavolino / Low table 50x35 cm



design Sergio Bicego
production year 2002
restyling 2019

technical data
p. 450

Limes New



Composizione 340×250 cm
in tessuto Avant-Après col.49
e divano 254×98 cm
in tessuto Avant-Après col.56
Poltrona Geo
Tavolini Hexa
Tavolino Più
Tavolino Haiku
Pouf Island

Composition 340×250 cm
in fabric Avant-Après col.49
and sofa 254×98 cm
in fabric Avant-Après col.56
Geo armchair
Hexa low tables
Più low table
Haiku low table
Island pouf

Composition 340×250 cm
en tissu Avant-Après col.49
et canapé 254×98 cm
en tissu Avant-Après col.56
Fauteuil Geo
Tables basses Hexa
Table basse Più
Table basse Haiku
Pouf Island

Composició 340×250 cm
de tela Avant-Après col.49
y sofá 254×98 cm
de tela Avant-Après col.56
Sillón Geo
Mesas de centro Hexa
Mesa de centro Più
Mesa de centro Haiku
Puf Island



Divano 254x98 cm
in tessuto
Avant-Après col.56
Poltroncina Baby Geo
Tavolino Ring

Sofa 254x98 cm
in fabric
Avant-Après col.56
Baby Geo small armchair
Ring low table



Canapé 254x98 cm
en tissu
Avant-Après col.56
Petit fauteuil Baby Geo
Table basse Ring

Sofá 254x98 cm
de tela
Avant-Après col.56
Pequeño sillón Baby Geo
Mesa de centro Ring



Composizione 340×250 cm
in tessuto
Avant-Après col.49
Poltrona Chillout
Tavolino Hexa
Tavolino Più
Tavolino Haiku

Composizione 340×250 cm
in fabric
Avant-Après col.49
Chillout armchair
Hexa low table
Più low table
Haiku low table

Composicion 340×250 cm
en tissu
Avant-Après col.49
Fauteuil Chillout
Table basse Hexa
Table basse Più
Table basse Haiku

Composición 340×250 cm
de tela
Avant-Après col.49
Sillón Chillout
Mesa de centro Hexa
Mesa de centro Più
Mesa de centro Haiku

Divano 254x98 cm
in tessuto
Avant-Après col.56

Sofa 254x98 cm
in fabric
Avant-Après col.56

Canapé 254x98 cm
en tissu
Avant-Après col.56

Sofá 254x98 cm
de tela
Avant-Après col.56



312 x 240 cm **Composizione / Composition A**

Elementi / Elements: 1 Base / Base 210x80 cm
1 Base / Base 230x80 cm
4 Schienali intreccio imbottito / Padded bridged backrests 60 cm
1 Cilindro bracciolo / Roll armrest
4 Cuscini schiena / Back cushions 85 cm
1 Cuscino bracciolo / Arm cushion 48x48 cm



312 x 240 cm **Composizione / Composition B**

Elementi / Elements: 1 Base / Base 210x80 cm
1 Base / Base 230x80 cm
4 Schienali intreccio imbottito / Padded bridged backrests 60 cm
1 Bracciolo intreccio imbottito / Padded bridged armrest
4 Cuscini schiena / Back cushions 85 cm
1 Cuscino bracciolo / Arm cushion 75x35 cm



Composizione / Composition C
Divani / Sofas 252 x 90 cm - 220 x 90 cm

- Elementi / Elements:
- 1 Base / Base 210x80 cm
 - 1 Base / Base 230x80 cm
 - 4 Schienali intreccio imbottito / Padded bridged backrests 60 cm
 - 1 Cilindro bracciolo / Roll armrest
 - 4 Cuscini schiena / Back cushions 85 cm
 - 1 Cuscino bracciolo / Arm cushion 48x48 cm



design Sergio Bicego
production year 2019

technical data
p. 452

Voyage





Divano 246x88 cm
in pelle Seta col. Biscotto
Tavolino Più

Sofa 246x88 cm
in leather Seta col. Biscotto
Più low table

Canapé 246x88 cm
en cuir Seta col. Biscotto
Table basse Più

Sofá 246x88 cm
de piel Seta col. Biscotto
Mesa de centro Più



Composizione 321x158 cm
in tessuto Elegance col.59
Poltrona e pouf Chillout
Tavolini Hexa
Tavolino Haiku

Composition 321x158 cm
in fabric Elegance col.59
Chillout armchair and pouf
Hexa low tables
Haiku low table

Composition 321x158 cm
en tissu Elegance col.59
Fauteuil et pouf Chillout
Tables basses Hexa
Table basse Haiku

Composición 321x158 cm
de tela Elegance col.59
Sillón y puf Chillout
Mesas de centro Hexa
Mesa de centro Haiku





(pp. 114-115)

Composizione 330x246 cm
in tessuto Elegance col.59
Poltroncina Ola
Tavolino Ring
Tavolino Haiku
Pouf Geo

Composition 330x246 cm
en tissu Elegance col.59
Petit fauteuil Ola
Table basse Ring
Table basse Haiku
Pouf Geo

Composition 330x246 cm
in fabric Elegance col.59
Ola small armchair
Ring low table
Haiku low table
Geo pouf

Composición 330x246 cm
de tela Elegance col.59
Pequeño sillón Ola
Mesa de centro Ring
Mesa de centro Haiku
Puf Geo





design Giuseppe Viganò
production year 2008

technical data
p. 454

Up

Composizione 360x170 cm
in pelle Natural col. Creta
Tavolini Più
Pouf Geo

Composition 360x170 cm
in leather Natural col. Creta
Più low tables
Geo pouf

Composition 360x170 cm
en cuir Natural col. Creta
Tables basses Più
Pouf Geo

Composició 360x170 cm
de piel Natural col. Creta
Mesas de centro Più
Puf Geo





Composizione 360x170 cm
in pelle Natural col. Creta

Composition 360x170 cm
in leather Natural col. Creta

Composition 360x170 cm
en cuir Natural col. Creta

Composición 360x170 cm
de piel Natural col. Creta



Divano 260×100 cm
in tessuto Kami col.11
Tavolino Leyva

Sofa 260×100 cm
in fabric Kami col.11
Leyva low table

Canapé 260×100 cm
en tissu Kami col.11
Table basse Leyva

Sofá 260×100 cm
de tela Kami col.11
Mesa de centro Leyva

design Sergio Bicego
production year 2016

technical data
p. 456

Essentiel



Composizione 275x160 cm
in tessuto Milly col.31
poltrona Chance
Tavolino Ring
Tavolini Più
Pouf Geo

Composition 275x160 cm
in fabric Milly col.31
Chance armchair
Ring low table
Più low tables
Geo pouf

Composition 275x160 cm
en tissu Milly col.31
Fauteuil Chance
Table basse Ring
Tables basses Più
Pouf Geo

Composición 275x160 cm
de tela Milly col.31
Sillón Chance
Mesa de centro Ring
Mesas de centro Più
Puf Geo



(pp. 130-131)

Divano 250×95 cm
in pelle Ocean col.14
Tavolino Hexa
Tavolini Leyva
Pouf Island

Sofa 250×95 cm
in leather Ocean col.14
Hexa low table
Leyva low tables
Island pouf

Canapé 250×95 cm
en cuir Ocean col.14
Table basse Hexa
Tables basses Leyva
Pouf Island

Sofá 250×95 cm
de piel Ocean col.14
Mesa de centro Hexa
Mesas de centro Leyva
Puf Island





134

135



(pp. 134-135)

Divano 220x95 cm
in tessuto Gatsby 1389 col.22
Poltroncina Baby Geo
Tavolino Più
Tavolino Ring

Sofa 220x95 cm
in fabric Gatsby 1389 col.22
Baby Geo small armchair
Più low table
Ring low table

Canapé 220x95 cm
en tissu Gatsby 1389 col.22
Petit fauteuil Baby Geo
Table basse Più
Table basse Ring

Sofá 220x95 cm
de tela Gatsby 1389 col.22
Pequeño sillón Baby Geo
Mesa de centro Più
Mesa de centro Ring

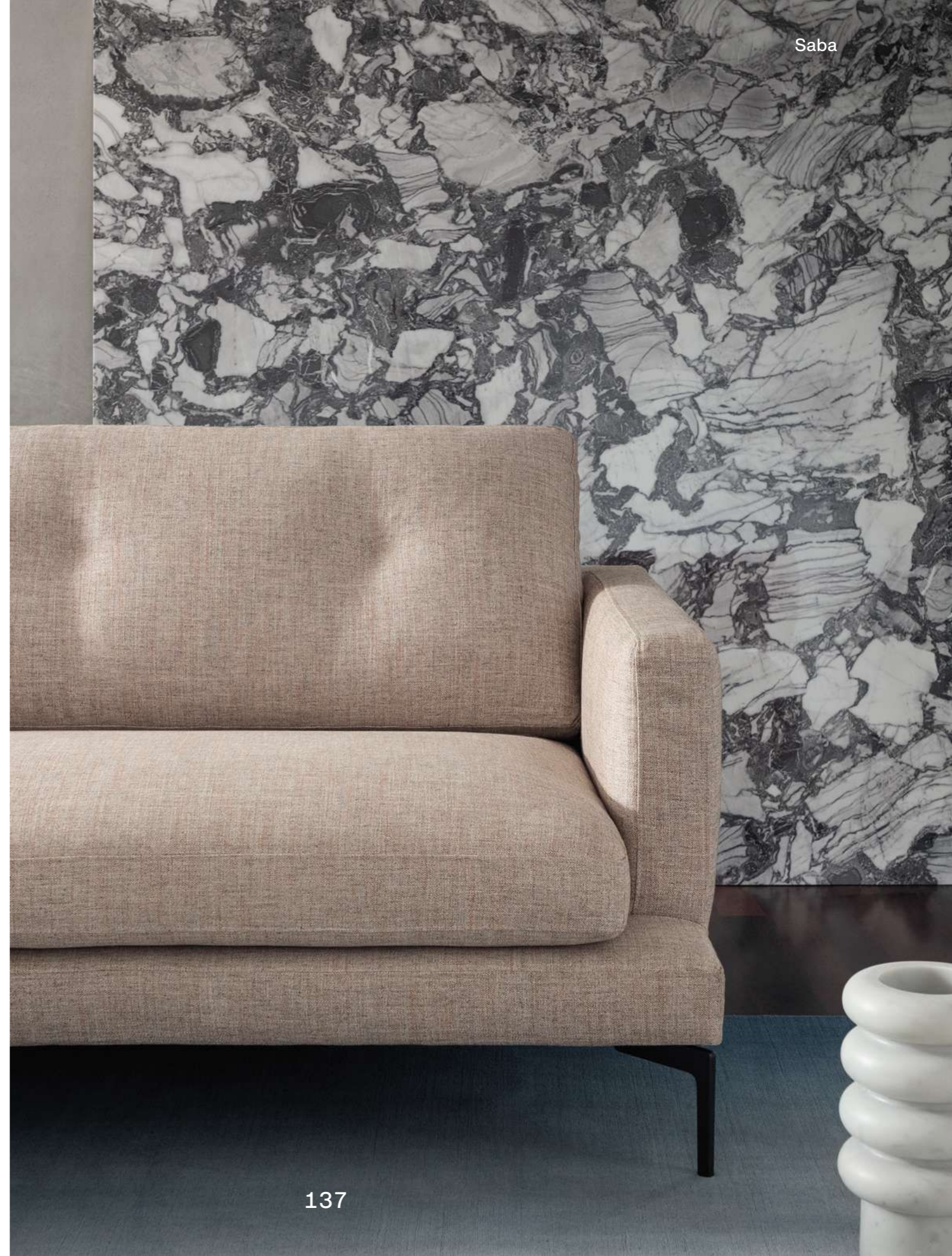

design Sergio Bicego
production year 2019

technical data
p. 458

Rendez-vous



Composizione 292x82 cm
in tessuto Sole CS col.403
Composizione 246x94 cm
in tessuto X076 col.22
Poltrona Geo
Poltroncina Ola
Tavolini Più

Composition 292x82 cm
in fabric Sole CS col.403
Composition 246x94 cm
in fabric X076 col.22
Geo armchair
Ola small armchair
Più low tables

Composition 292x82 cm
en tissu Sole CS col.403
Composition 246x94 cm
en tissu X076 col.22
Fauteuil Geo
Petit fauteuil Ola
Tables basses Più

Composició 292x82 cm
de tela Sole CS col.403
Composició 246x94 cm
de tela X076 col.22
Sillón Geo
Pequeño sillón Ola
Mesas de centro Più





Composizione 234x82 cm
in tessuto Teddy col.07/24
Tavolino Ring

Composition 234x82 cm
in fabric Teddy col.07/24
Ring low table

Composition 234x82 cm
en tissu Teddy col.07/24
Table basse Ring

Composición 234x82 cm
de tela Teddy col.07/24
Mesa de centro Ring



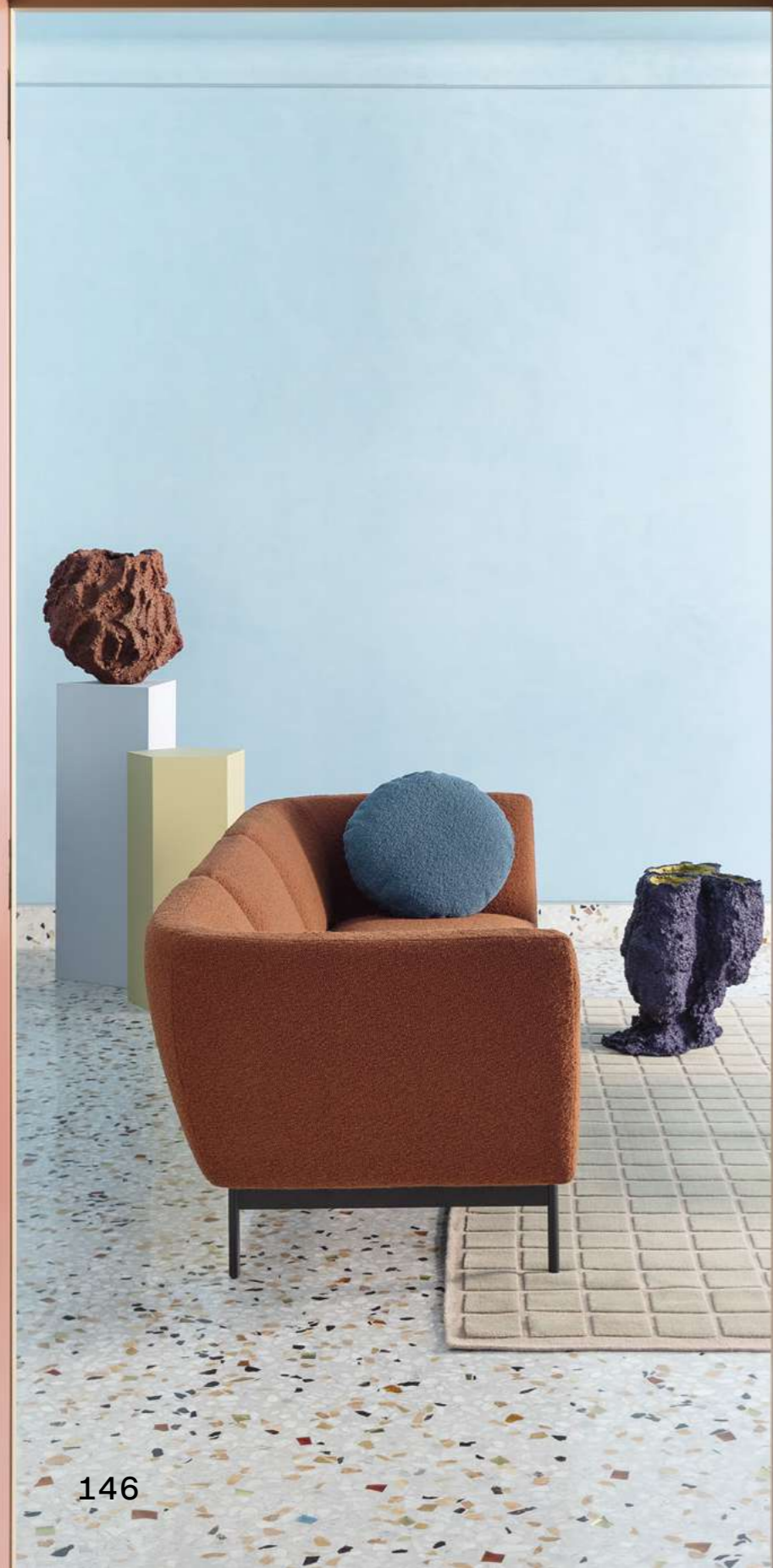

Composizione 246x94 cm
in tessuto X706 col.22

Composition 246x94 cm
en tissu X706 col.22

Composition 246x94 cm
in fabric X706 col.22

Composición 246x94 cm
de tela X706 col.22

Composizione 246x94 cm
in tessuto X076 col.22
Composizione 140x70 cm
in tessuto Sole CS col.403
Poltrona Chillout
Tavolino Hexa

Composition 246x94 cm
in fabric X076 col.22
Composition 140x70 cm
in fabric Sole CS col.403
Chillout armchair
Hexa low table

Composition 246x94 cm
en tissu X076 col.22
Composition 140x70 cm
en tissu Sole CS col.403
Fauteuil Chillout
Table basse Hexa

Composición 246x94 cm
de tela X076 col.22
Composición 140x70 cm
de tela Sole CS col.403
Sillón Chillout
Mesa de centro Hexa



Composizioni
188x94 cm
in tessuto Violet col.08

Compositions
188x94 cm
in fabric Violet col.08

Compositions
188x94 cm
en tissu Violet col.08

Composiciones
188x94 cm
de tela Violet col.08



292 x 82 cm **Composizione / Composition A**

Elementi / Elements:
1 Angolare DX / Right corner unit 82x82 cm
1 Ripiano / Shelf unit 70x70 cm
2 Centrali / Central units 70x82 cm
1 Cuscino arredo con fascia / Throw cushion with band diam. 47 cm



292 x 222 cm **Composizione / Composition B**

Elementi / Elements:
1 Ripiano / Shelf unit 35x70 cm
1 Centrale / Central unit 105x82 cm
1 Ripiano / Shelf unit 70x70 cm
1 Pouf 70x70 cm
2 Centrali / Central units 70x82 cm
1 Cuscino arredo con fascia / Throw cushion with band diam. 47 cm



258 x 94 cm **Composizione / Composition C**

Elementi / Elements:
 1 Angolare curvo SX / Left curved corner unit 94x94 cm
 1 Centrale curvo / Central curved unit 70x94 cm
 1 Angolare curvo DX / Right curved corner unit 94x94 cm
 3 Cuscini schiena / Back cushions 60x33 cm



258 x 234 cm **Composizione / Composition D**

Elementi / Elements:
 1 Pouf 70x70 cm
 1 Centrale curvo / Central curved unit 70x94 cm
 1 Angolare curvo SX / Left curved corner unit 94x94 cm
 1 Centrale / Central unit 70x82 cm
 1 Angolare curvo DX / Right curved corner unit 94x94 cm
 2 Cuscini schiena / Back cushions 60x33 cm
 1 Cuscino arredo con fascia / Throw cushion with band diam. 47 cm



Composizione 188x94 cm
 in tessuto Violet col.31
 Tavolini Hexa
 Tavolino Più

Composition 188x94 cm
 in fabric Violet col.31
 Hexa low tables
 Più low table

Composition 188x94 cm
 en tissu Violet col.31
 Tables basses Hexa
 Table basse Più

Composició 188x94 cm
 de tela Violet col.31
 Mesas de centro Hexa
 Mesa de centro Più



design Giuseppe Viganò
production year 2009

technical data
p. 460

Les Femmes

Composizione 312x95 cm
in tessuto Lima col.29
Tavolini Leyva

Composition 312x95 cm
in fabric Lima col.29
Leyva low tables

Composition 312x95 cm
en tissu Lima col.29
Tables basses Leyva

Composición 312x95 cm
de tela Lima col.29
Mesas de centro Leyva



Composizione 190x95 cm
e pouf 95x95 cm
in tessuto Cassiopea col.11
Tavolini Più

Composition 190x95 cm
and pouf 95x95 cm
in fabric Cassiopea col.11
Più low tables

Composition 190x95 cm
et pouf 95x95 cm
en tissu Cassiopea col.11
Tables basses Più

Composición 190x95 cm
y puf 95x95 cm
de tela Cassiopea col.11
Mesas de centro Più



design Giuseppe Viganò
production year 2009

technical data
p. 463

Livingston



Divano 240×102 cm
in tessuto Creta col.15
Poltrona 82×85 cm
in tessuto Creta col.15
Tavolini Più

Sofa 240×102 cm
in fabric Creta col.15
Armchair 82×85 cm
in fabric Creta col.15
Più low tables

Canapé 240×102 cm
en tissu Creta col.15
Fauteuil 82×85 cm
en tissu Creta col.15
Tables basses Più

Sofá 240×102 cm
de tela Creta col.15
Sillón 82×85 cm
de tela Creta col.15
Mesas de centro Più



Composizione 326×102 cm
in tessuto Sweet Velvet col.116
Tavolino Ring
Tavolino Più

Composition 326×102 cm
in fabric Sweet Velvet col.116
Ring low table
Più low table

Composition 326×102 cm
en tissu Sweet Velvet col.116
Table basse Ring
Table basse Più

Composició 326×102 cm
de tela Sweet Velvet col.116
Mesa de centro Ring
Mesa de centro Più





Composizione 326×102 cm
in tessuto Sweet Velvet col.116
Tavolino Più

Composition 326×102 cm
in fabric Sweet Velvet col.116
Più low table

Composition 326×102 cm
en tissu Sweet Velvet col.116
Table basse Più

Composició 326×102 cm
de tela Sweet Velvet col.116
Mesa de centro Più



design Paolo Grasselli
production year 2018

technical data
p. 466

Geo



Divano 153x84 cm
in tessuto
Sweet Velvet col.24
Poltrona 90x82 cm
e pouf 60 cm
in tessuto J'Ador col.08
Tavolini Leyva
Tavolino Hexa

Sofa 153x84 cm
in fabric
Sweet Velvet col.24
Armchair 90x82 cm
and pouf 60 cm
in fabric J'Ador col.08
Leyva low tables
Hexa low table

Canapé 153x84 cm
en tissu
Sweet Velvet col.24
Fauteuil 90x82 cm
et pouf 60 cm
en tissu J'Ador col.08
Tables basses Leyva
Table basse Hexa

Sofá 153x84 cm
de tela
Sweet Velvet col.24
Sillón 90x82 cm
y puf 60 cm
de tela J'Ador col.08
Mesas de centro Leyva
Mesa de centro Hexa

design Marco Zito
production year 2019

technical data
p. 468

Philo







(p. 174)
 Divano 3 posti 216x70 cm
 in tessuto Sole CS col.406
 Divano 2 posti 160x70 cm
 in tessuto Sole CS col.407
 Poltrone 83x70 cm
 in tessuto Seventy col.90

Sofa 3 seating 216x70 cm
 in fabric Sole CS col.406
 Sofa 2 seating 160x70 cm
 in fabric Sole CS col.407
 Armchairs 83x70 cm
 in fabric Seventy col.90

Canapé 3 places 216x70 cm
 en tissu Sole CS col.406
 Canapé 2 places 160x70 cm
 en tissu Sole CS col.407
 Fauteuils 83x70 cm
 en tissu Seventy col.90

Sofá 3 asientos 216x70 cm
 de tela Sole CS col.406
 Sofá 2 asientos 160x70 cm
 de tela Sole CS col.407
 Sillones 83x70 cm
 de tela Seventy col.90

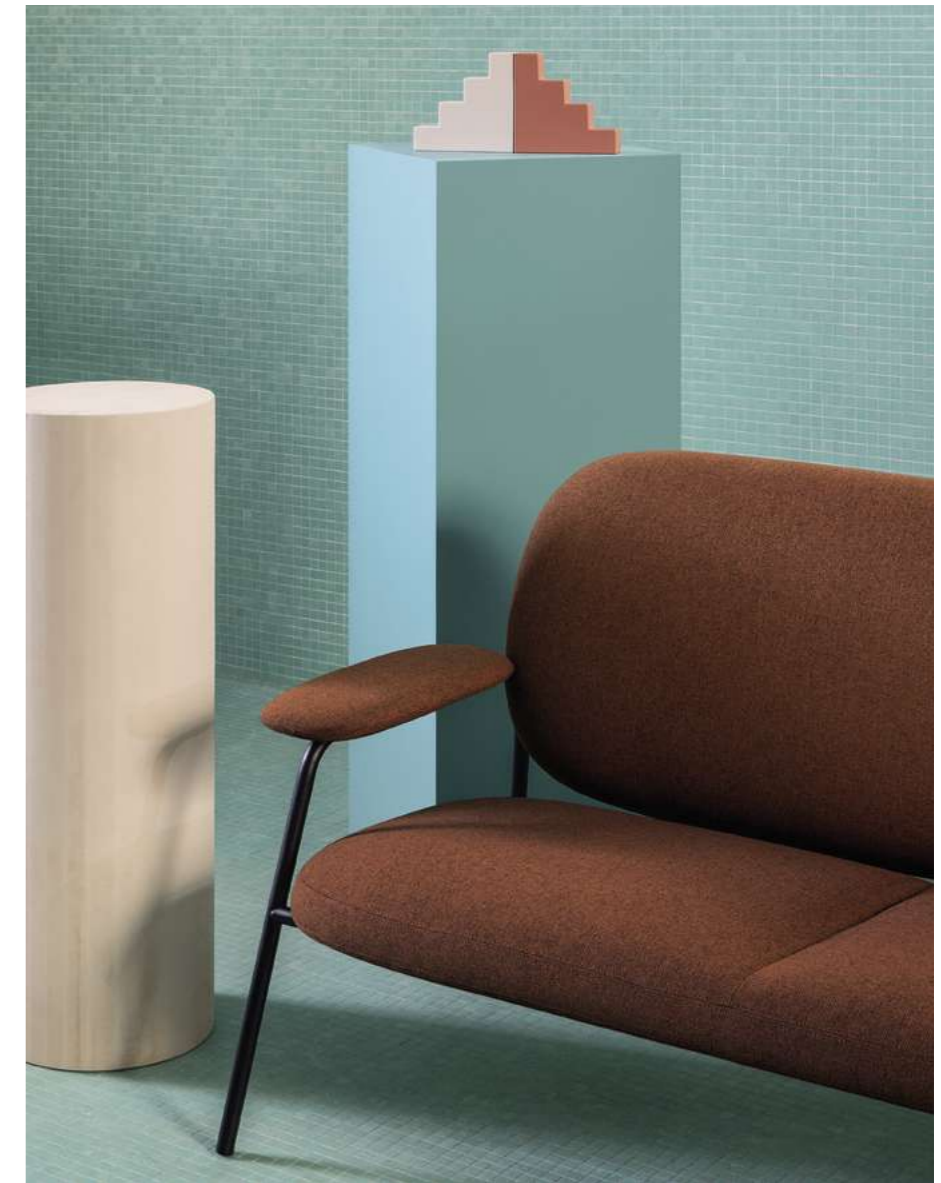

Divano 2 posti 160x70 cm
 in tessuto Sole CS col.407
 Pouf Geo

Sofa 2 seating 160x70 cm
 in fabric Sole CS col.407
 Geo pouf

Canapé 2 places 160x70 cm
 en tissu Sole CS col.407
 Pouf Geo

Sofá 2 asientos 160x70 cm
 de tela Sole CS col.407
 Puf Geo

design Emilio Nanni
production year 2018

technical data
p. 470

Kepi



Divano 160x80 cm
in tessuto Saint Moritz col.150
Poltrona 90x78 cm
in tessuto Diplo col.24
Pouf 65x44 cm
in tessuto Vegas Velvet col.57
Tavolino Più

Sofa 160x80 cm
in fabric Saint Moritz col.150
Armchair 90x78 cm
in fabric Diplo col.24
Pouf 65x44 cm
in fabric Vegas Velvet col.57
Più low table

Canapé 160x80 cm
en tissu Saint Moritz col.150
Fauteuil 90x78 cm
en tissu Diplo col.24
Pouf 65x44 cm
en tissu Vegas Velvet col.57
Table basse Più

Sofá 160x80 cm
de tela Saint Moritz col.150
Sillón 90x78 cm
de tela Diplo col.24
Puf 65x44 cm
de tela Vegas Velvet col.57
Mesa de centro Più

design Sergio Bicego
production year 2019

technical data
p. 472

New York Dining



Panchetta 143x54 cm
in tessuto Sweet Velvet col.62
Tavolino Hexa

Bench 143x54 cm
in fabric Sweet Velvet col.62
Hexa low table

Banc 143x54 cm
en tissu Sweet Velvet col.62
Table basse Hexa

Banco 143x54 cm
de tela Sweet Velvet col.62
Mesa de centro Hexa



design Sergio Bicego
production year 1996
restyling 2015

technical data
p. 473

Saba

Quinta Strada





Composizione 318x150 cm
in tessuto Creta col.71
Pouf Honey

Composition 318x150 cm
in fabric Creta col.71
Honey pouf

Composition 318x150 cm
en tissu Creta col.71
Pouf Honey

Composición 318x150 cm
de tela Creta col.71
Puf Honey





(pp. 190-191)

Composizione 330x205 cm
in tessuto Gatsby 1389 col.04
Pouf e tavolino Ziggy
New York Bergère

Composition 330x205 cm
in fabric Gatsby 1389 col.04
Ziggy pouf and low table
New York Bergère

Composition 330x205 cm
en tissu Gatsby 1389 col.04
Pouf et table basse Ziggy
New York Bergère

Composición 330x205 cm
de tela Gatsby 1389 col.04
Puf y mesa de centro Ziggy
New York Bergère





design Sergio Bicego
production year 1999
restyling 2013

technical data
p. 476

Karma

Divano 300×110 cm
in tessuto Creta col.15
Poltrona New York
Tavolini Più

Sofa 300×110 cm
in fabric Creta col.15
New York armchair
Più low tables

Canapé 300×110 cm
en tissu Creta col.15
Fauteuil New York
Tables basses Più

Sofá 300×110 cm
de tela Creta col.15
Sillón New York
Mesas de centro Più



Composizione 300x160 cm
in tessuto Creta col.15

Composition 300x160 cm
in fabric Creta col.15

Composition 300x160 cm
en tissu Creta col.15

Composición 300x160 cm
de tela Creta col.15





Armchairs & Poufs

202	No Logo Light
208	New York Armchair
208	New York Bergère
214	Geo
214	Baby Geo
222	Chance
226	Chillout
230	Amélie
234	Bustier
238	Essentiel
238	Baby Essentiel
244	Kepi
250	Philo
254	Valentine
256	Livingston
258	Sitar
264	Ola
268	Geo Pouf
270	Island
272	Cookie
276	Pixel Pouf
278	Honey

design Sergio Bicego
production year 2005
restyling 2012

technical data
p. 478

No Logo Light





(pp. 204-205)

Poltrone 81x93 cm
in tessuto Teddy col.07/24
Tavolino Più

Armchairs 81x93 cm
in fabric Teddy col.07/24
Più low table

Fauteuils 81x93 cm
en tissu Teddy col.07/24
Table basse Più

Sillones 81x93 cm
de tela Teddy col.07/24
Mesa de centro Più



design Sergio Bicego
production year 2012/2014

technical data
pp. 479, 480

New York Armchair New York Bergère



Poltrona 74x83 cm
in tessuto Violet col.08
e Tundra 01 col.21
Tavolino Più

Armchair 74x83 cm
in fabric Violet col.08
and Tundra 01 col.21
Più low table

Fauteuil 74x83 cm
en tissu Violet col.08
et Tundra 01 col.21
Table basse Più

Sillón 74x83 cm
de tela Violet col.08
y Tundra 01 col.21
Mesa de centro Più





Bergère 74x91 cm
in tessuto Seventy col.30
e pelle Club col.7748
Pouf 58x50 cm
in pelle Club col.7748
Consolle Hexa

Bergère 74x91 cm
in fabric Seventy col.30
and leather Club col.7748
Pouf 58x50 cm
in leather Club col.7748
Hexa console

Bergère 74x91 cm
en tissu Seventy col.30
et cuir Club col.7748
Pouf 58x50 cm
en cuir Club col.7748
Console Hexa

Bergère 74x91 cm
de tela Seventy col.30
y piel Club col.7748
Puf 58x50 cm
de piel Club col.7748
Consola Hexa



design Paolo Grasselli
production year 2018/2019

technical data
pp. 481, 482

Geo Baby Geo



(p. 214)

Poltrona 90x82 cm
e pouf 60 cm
in tessuto J'Ador col.08
Tavolino Leyva

Armchair 90x82 cm
and pouf 60cm
in fabric J'Ador col.08
Leyva low table

Fauteuil 90x82 cm
et pouf 60 cm
en tissu J'Ador col.08
Table basse Leyva

Sillón 90x82 cm
y puf 60 cm
de tela J'Ador col.08
Mesa de centro Leyva

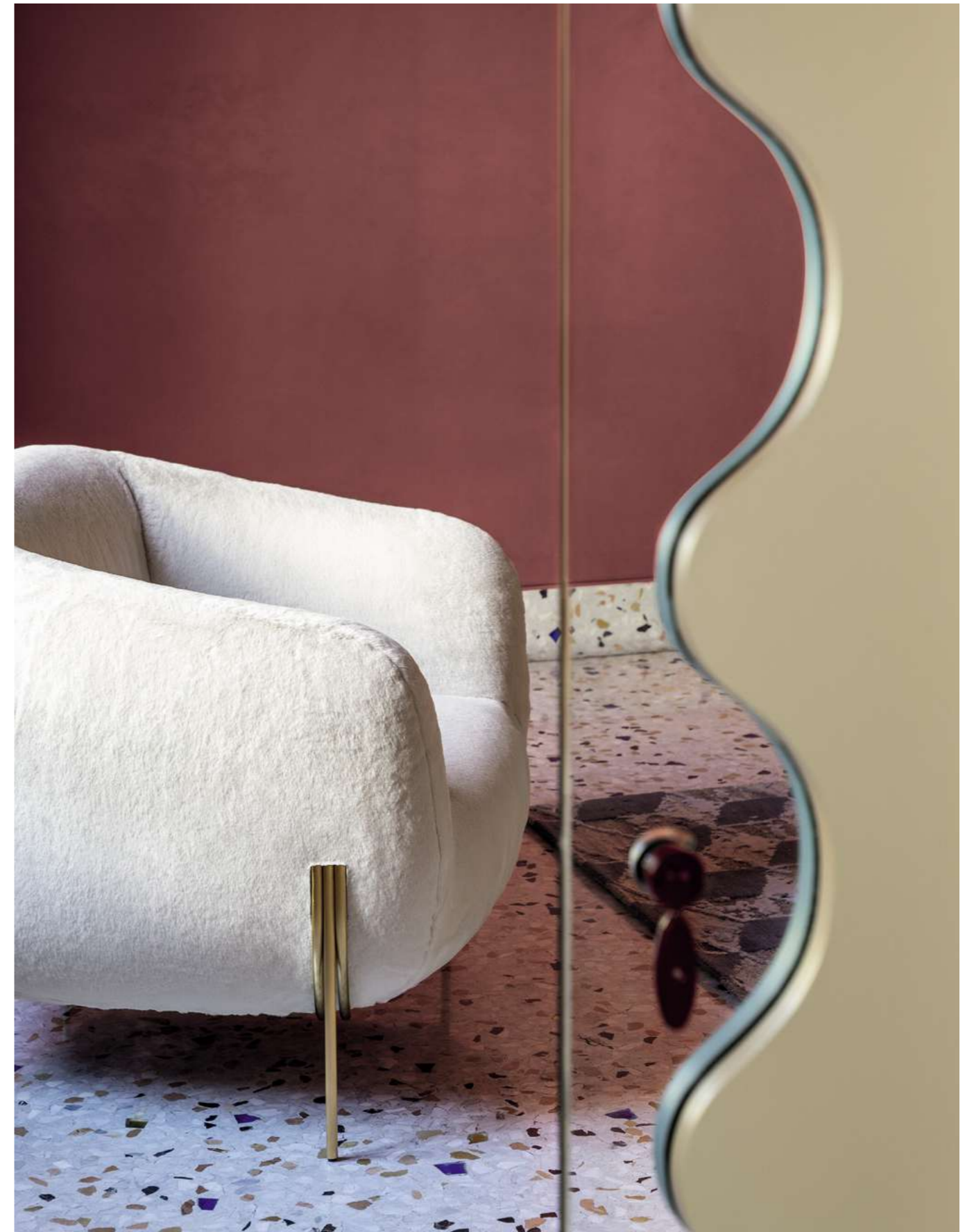

Poltroncina 75x80 cm
in tessuto
Catch Me col. Caccia Chioma
e Vegas Velvet col.33
Poltroncina 75x80 cm
in tessuto Sweet Velvet col.144
Tavolini Più
Tavolino Leyva
Pouf Geo

Small armchair 75x80 cm
in fabric
Catch Me col. Caccia Chioma
and Vegas Velvet col.33
Small armchair 75x80 cm
in fabric Sweet Velvet col.144
Più low tables
Leyva low table
Geo pouf

Petit fauteuil 75x80 cm
en tissu
Catch Me col. Caccia Chioma
et Vegas Velvet col.33
Petit fauteuil 75x80 cm
en tissu Sweet Velvet col.144
Tables basses Più
Table basse Leyva
Pouf Geo

Pequeño sillón 75x80 cm
de tela
Catch Me col. Caccia Chioma
et Vegas Velvet col.33
Pequeño sillón 75x80 cm
de tela Sweet Velvet col.144
Mesas de centro Più
Mesa de centro Leyva
Puf Geo





Poltroncina 75x80 cm
in tessuto
Vegas Velvet col.14
e J'Ador col.07
Tavolini Più

Small armchair 75x80 cm
in fabric
Vegas Velvet col.14
and J'Ador col.07
Più low tables



Petit fauteuil 75x80 cm
en tissu
Vegas Velvet col.14
et J'Ador col.07
Tables basses Più

Pequeño sillón 75x80 cm
de tela
Vegas Velvet col.14
y J'Ador col.07
Mesas de centro Più

design Sergio Bicego
production year 2003

technical data
p. 483

Chance



Poltrona 80x80 cm
in tessuto J'Ador col.08
Tavolino Più

Armchair 80x80 cm
in fabric J'Ador col.08
Più low table

Fauteuil 80x80 cm
en tissu J'Ador col.08
Table basse Più

Sillón 80x80 cm
de tela J'Ador col.08
Mesa de centro Più



design Giuseppe Viganò
production year 2016

technical data
p. 484

Chillout



Poltrona 84x90 cm
e pouf 61x48 cm
in tessuto
Vegas Velvet col.14

Armchair 84x90 cm
and pouf 61x48 cm
in fabric
Vegas Velvet col.14

Fauteuil 84x90 cm
et pouf 61x48 cm
en tissu
Vegas Velvet col.14

Sillón 84x90 cm
y puf 61x48 cm
de tela
Vegas Velvet col.14



design Sergio Bicego
production year 2012

technical data
p. 485

Amélie



Poltroncina 73x70 cm
in tessuto
Vegas Velvet col.20

Small armchair 73x70 cm
in fabric
Vegas Velvet col.20

Petit fauteuil 73x70 cm
en tissu
Vegas Velvet col.20

Pequeño sillón 73x70 cm
de tela
Vegas Velvet col.20



design Giuseppe Viganò
production year 2010

technical data
p. 486

Bustier



Poltrona 86x84 cm
in tessuto Violet col.31
Tavolino Hexa

Armchair 86x84 cm
in fabric Violet col.31
Hexa low table

Fauteuil 86x84 cm
en tissu Violet col.31
Table basse Hexa

Sillón 86x84 cm
de tela Violet col.31
Mesa de centro Hexa



design Sergio Bicego
production year 2016/2020

technical data
pp. 487, 488

Essentiel

Baby Essentiel



Poltrone 87x95 cm
in tessuto Lario col.58
Tavolino Ring
Console Hexa

Armchairs 87x95 cm
in fabric Lario col.58
Ring low table
Hexa console

Fauteuils 87x95 cm
en tissu Lario col.58
Table basse Ring
Console Hexa

Sillones 87x95 cm
de tela Lario col.58
Mesa de centro Ring
Consola Hexa



Poltroncina 75x77 cm
in tessuto Smile col.13

Small armchair 75x77 cm
in fabric Smile col.13

Petit fauteuil 75x77 cm
en tissu Smile col.13

Pequeño sillón 75x77 cm
de tela Smile col.13





design Emilio Nanni
production year 2016

technical data
p. 490

Kepi

Poltrona 90x78 cm
in tessuto Seventy col.01

Armchair 90x78 cm
in fabric Seventy col.01

Fauteuil 90x78 cm
en tissu Seventy col.01

Sillón 90x78 cm
de tela Seventy col.01





248



Poltrona 90x78 cm
in tessuto Diplo col.24
Tavolino Più

Armchair 90x78 cm
in fabric Diplo col.24
Più low table

Fauteuil 90x78 cm
en tissu Diplo col.24
Table basse Più

Sillón 90x78 cm
de tela Diplo col.24
Mesa de centro Più

249

design Marco Zito
production year 2019

technical data
p. 489

Philo





Poltrone 83x70 cm
in tessuto Seventy col.99
Tavolino Hexa

Armchairs 83x70 cm
in fabric Seventy col.99
Hexa low table

Fauteuils 83x70 cm
en tissu Seventy col.99
Table basse Hexa

Sillones 83x70 cm
de tela Seventy col.99
Mesa de centro Hexa



design
Marzia e Leonardo Dainelli
production year 2012

technical data
p. 492

Valentine



254

Poltrona 95×100 cm
e pouf 95×60 cm
in tessuto Kami col.11
Tavolino Più

Armchair 95×100 cm
and pouf 95×60 cm
in fabric Kami col.11
Più low table

Fauteuil 95×100 cm
et pouf 95×60 cm
en tissu Kami col.11
Table basse Più

Sillón 95×100 cm
y puf 95×60 cm
de tela Kami col.11
Mesa de centro Più

255

design Giuseppe Viganò
production year 2009

technical data
p. 493

Livingston



256

Poltrona 82x85 cm
in tessuto Creta col.15

Armchair 82x85 cm
in fabric Creta col.15

Fauteuil 82x85 cm
en tissu Creta col.15

Sillón 82x85 cm
de tela Creta col.15

257

design Enzo Berti
production year 2006/2018

technical data
p. 496

Sitar





(p. 258)

Poltrona 77×79 cm
in Intreccio Monocolore
Tavolini Più
Paravento Shade

Armchair 77×79 cm
in Monocolor Braid
Più low tables
Shade divider

Fauteuil 77×79 cm
en Tresse Monocolore
Tables basses Più
Paravent Shade

Sillón 77×79 cm
en Trenza Monocolor
Mesas de centro Più
Biombo Shade

Poltrona 77×79 cm
e pouf 77×65 cm
in Intreccio Bicolore
Paraventi Shade

Armchair 77×79 cm
and pouf 77×65 cm
in Bicolor Braid
Shade dividers

Fauteuil 77×79 cm
et pouf 77×65 cm
en Tresse Bicolore
Paravents Shade

Sillón 77×79 cm
y pouf 77×65 cm
en Trenza Bicolor
Biombo Shade



Poltrone 77x79 cm
e pouf 77x65 cm
in Intreccio Bicolore
Tavolini Più
Paraventi Shade

Armchairs 77x79 cm
and pouf 77x65 cm
in Bicolor Braid
Più low tables
Shade dividers

Fauteuils 77x79 cm
et pouf 77x65 cm
en Tresse Bicolore
Tables basses Più
Paravents Shade

Sillones 77x79 cm
y puf 77x65 cm
en Trenza Bicolor
Mesa de centro Ring
Biombos Shade

design T.S.P.
(Resp. Nicola Pavan)
production year 2019

technical data
p. 494

Ola





(p. 264)

Poltroncina 60x74 cm
in tessuto J'Ador col.07
Tavolino Più
Pouf Geo

Small armchair 60x74 cm
in fabric J'Ador col.07
Più low table
Geo pouf

Petit fauteuil 60x74 cm
en tissu J'Ador col.07
Table basse Più
Pouf Geo

Pequeño sillón 60x74 cm
de tela J'Ador col.07
Mesa de centro Più
Puf Geo



Poltroncina con
braccioli 67x74 cm
in tessuto J'Ador col.08

Small armchair with
armrests 67x74 cm
in fabric J'Ador col.08

Petit fauteuil avec
accoudoirs 67x74 cm
en tissu J'Ador col.08

Pequeño sillón con
brazos 67x74 cm
de tela J'Ador col.08

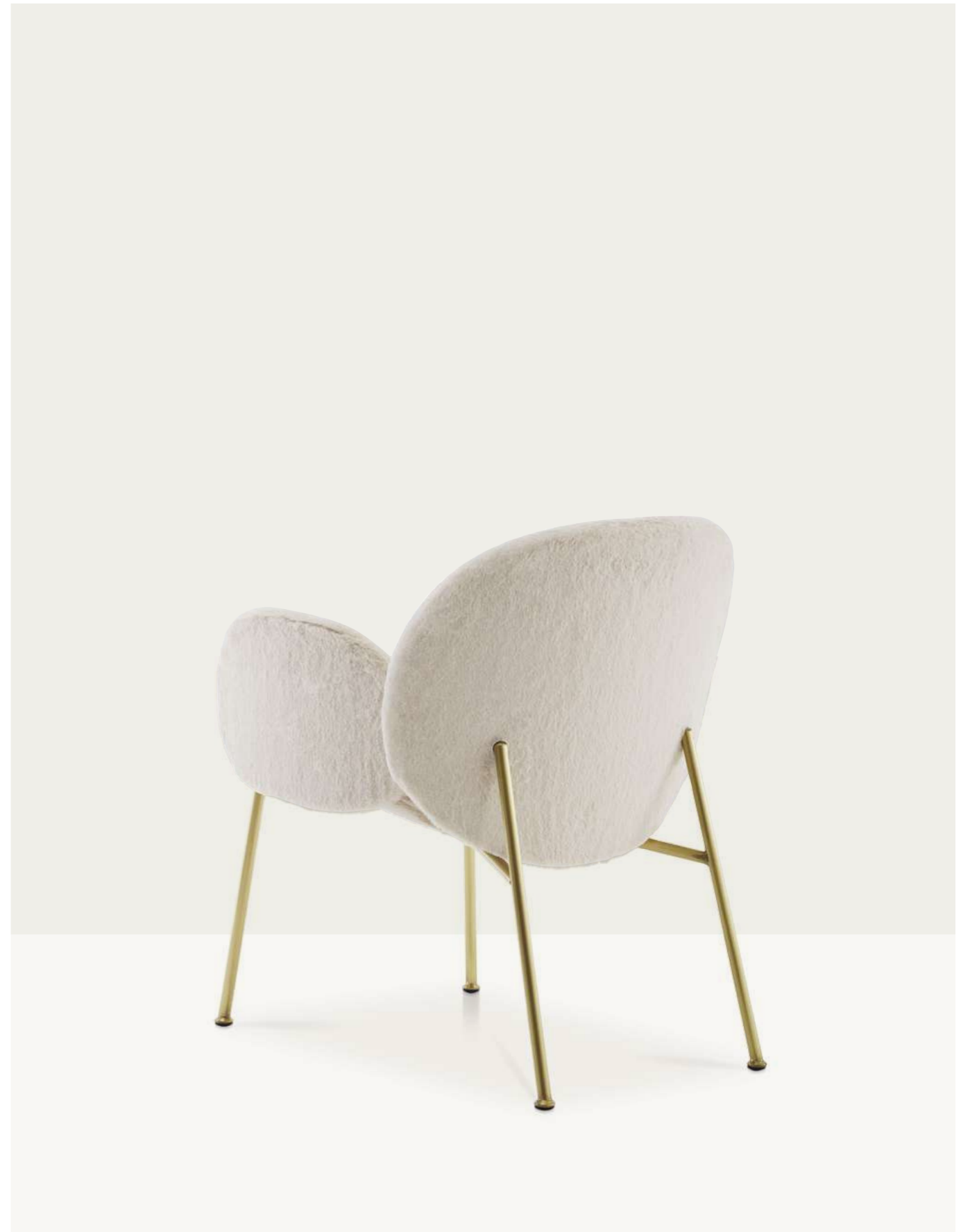

design Paolo Grasselli
production year 2017

technical data
p. 497

Geo Pouf



Pouf 60 cm in tessuto
Couture col.260
Pouf 75 cm in tessuto
Violet col.12
Pouf 90 cm in tessuto
J'Ador col.08

Pouf 60 cm in fabric
Couture col.260
Pouf 75 cm in fabric
Violet col.12
Pouf 90 cm in fabric
J'Ador col.08

Pouf 60 cm en tissu
Couture col.260
Pouf 75 cm en tissu
Violet col.12
Pouf 90 cm en tissu
J'Ador col.08

Pouf 60 cm de tela
Couture col.260
Pouf 75 cm de tela
Violet col.12
Pouf 90 cm de tela
J'Ador col.08

Island



Pouf 65x50 cm in tessuto
Capri col.44
Pouf 83x65 cm in tessuto
Gatsby 1389 col.07
Pouf 130x105 cm in tessuto
Sweet Velvet col.24
Consolle Hexa

Pouf 65x50 cm in fabric
Capri col.44
Pouf 83x65 cm in fabric
Gatsby 1389 col.07
Pouf 130x105 cm in fabric
Sweet Velvet col.24
Hexa console

Pouf 65x50 cm en tissu
Capri col.44
Pouf 83x65 cm en tissu
Gatsby 1389 col.07
Pouf 130x105 cm en tissu
Sweet Velvet col.24
Console Hexa

Puf 65x50 cm de tela
Capri col.44
Puf 83x65 cm de tela
Gatsby 1389 col.07
Puf 130x105 cm de tela
Sweet Velvet col.24
Consola Hexa

design Sergio Bicego
production year 2020

technical data
p. 499

Cookie



Pouf tondo 100 cm
in tessuto Violet col.05
Pouf tondo 130 cm
in tessuto Vegas Velvet col.60
Pouf 75x75 cm in tessuto
Creta col.3E

Round pouf 100 cm
in fabric Violet col.05
Round pouf 130 cm
in fabric Vegas Velvet col.60
Pouf 75x75 cm in fabric
Creta col.3E

Pouf rond 100 cm
en tissu Violet col.05
Pouf rond 130 cm
en tissu Vegas Velvet col.60
Pouf 75x75 cm en tissu
Creta col.3E

Puf redondo 100 cm
de tela Violet col.05
Puf redondo 130 cm
de tela Vegas Velvet col.60
Puf 75x75 cm de tela
Creta col.3E



design Sergio Bicego
production year 2019

technical data
p. 500

Pixel Pouf



276

Pouf 42×42 cm
in tessuto
Avant-Après col.18
Tavolino Più

Pouf 42×42 cm
in fabric
Avant-Après col.18
Più low table

Pouf 42×42 cm
en tissu
Avant-Après col.18
Table basse Più

Puf 42×42 cm
de tela
Avant-Après col.18
Mesa de centro Più

277



design
Fabio Calvi e Paolo Brambilla
production year 2013

technical data
p. 501

Honey

Pouf 80x70 cm
in tessuto Creta col.71
Pouf 80x70 cm
in tessuto Creta col.12
Poltrona Kepi

Pouf 80x70 cm
in fabric Creta col.71
Pouf 80x70 cm
in fabric Creta col.12
Kepi armchair

Pouf 80x70 cm
en tissu Creta col.71
Pouf 80x70 cm
en tissu Creta col.12
Fauteuil Kepi

Puf 80x70 cm
de tela Creta col.71
Puf 80x70 cm
e tela Creta col.12
Sillón Kepi

Chairs & Stools



282	New York Chair
282	New York Dining
282	New York Stool
294	New York Chair by Marras
300	Ola Chair
300	Ola Stool
308	Isabelle Chair
308	Isabelle Stool

design Sergio Bicego
production year 2014/2019
/2016

technical data
pp. 502, 504, 505

New York Chair New York Dining New York Stool



Sedia con braccioli 59x54 cm
in tessuto Gatsby 1389 col.07
Sedia 56x54 cm
in tessuto Vegas Velvet col.54

Chair with armrests 59x54 cm
in fabric Gatsby 1389 col.07
Chair 56x54 cm
in fabric Vegas Velvet col.54

Chaise avec accoudoirs 59x54 cm
en tissu Gatsby 1389 col.07
Chaise 56x54 cm
en tissu Vegas Velvet col.54

Silla con brazos 59x54 cm
de tela Gatsby 1389 col.07
Silla 56x54 cm
de tela Vegas Velvet col.54



Sedia 56x54 cm in tessuto
Vegas Velvet col.54
Tavolini Più

Chair 56x54 cm in fabric
Vegas Velvet col.54
Più low tables

Chaise 56x54 cm
en tissu Vegas Velvet col.54
Tables basses Più

Silla 56x54 cm
de tela Vegas Velvet col.54
Mesas de centro Più





(pp. 288-289)

Sedie con braccioli 59x54 cm
in tessuto Gatsby 1389 col.07
Sedia 56x54 cm
in tessuto Vegas Velvet col.54
Panchetta 143x54 cm
in tessuto Sweet Velvet col.62
New York Bergère e pouf
Console Hexa
Pouf Geo

Chairs with armrests 59x54 cm
in fabric Gatsby 1389 col.07
Chair 56x54 cm
in fabric Vegas Velvet col.54
Bench 143x54 cm
in fabric Sweet Velvet col.62
New York Bergère and pouf
Hexa console
Geo pouf

Chaises avec accoudoirs 59x54 cm
en tissu Gatsby 1389 col.07
Chaise 56x54 cm
en tissu Vegas Velvet col.54
Banc 143x54 cm
en tissu Sweet Velvet col.62
New York Bergère et pouf
Console Hexa
Pouf Geo

Sillas con brazos 59x54 cm
de tela Gatsby 1389 col.07
Silla 56x54 cm
de tela Vegas Velvet col.54
Banco 143x54 cm
de tela Sweet Velvet col.62
New York Bergère y puf
Consola Hexa
Puf Geo

Panchetta 143x54 cm
in tessuto
Sweet Velvet col.62

Bench 143x54 cm
in fabric
Sweet Velvet col.62

Banc 143x54 cm
en tissu
Sweet Velvet col.62

Banco 143x54 cm
de tela
Sweet Velvet col.62



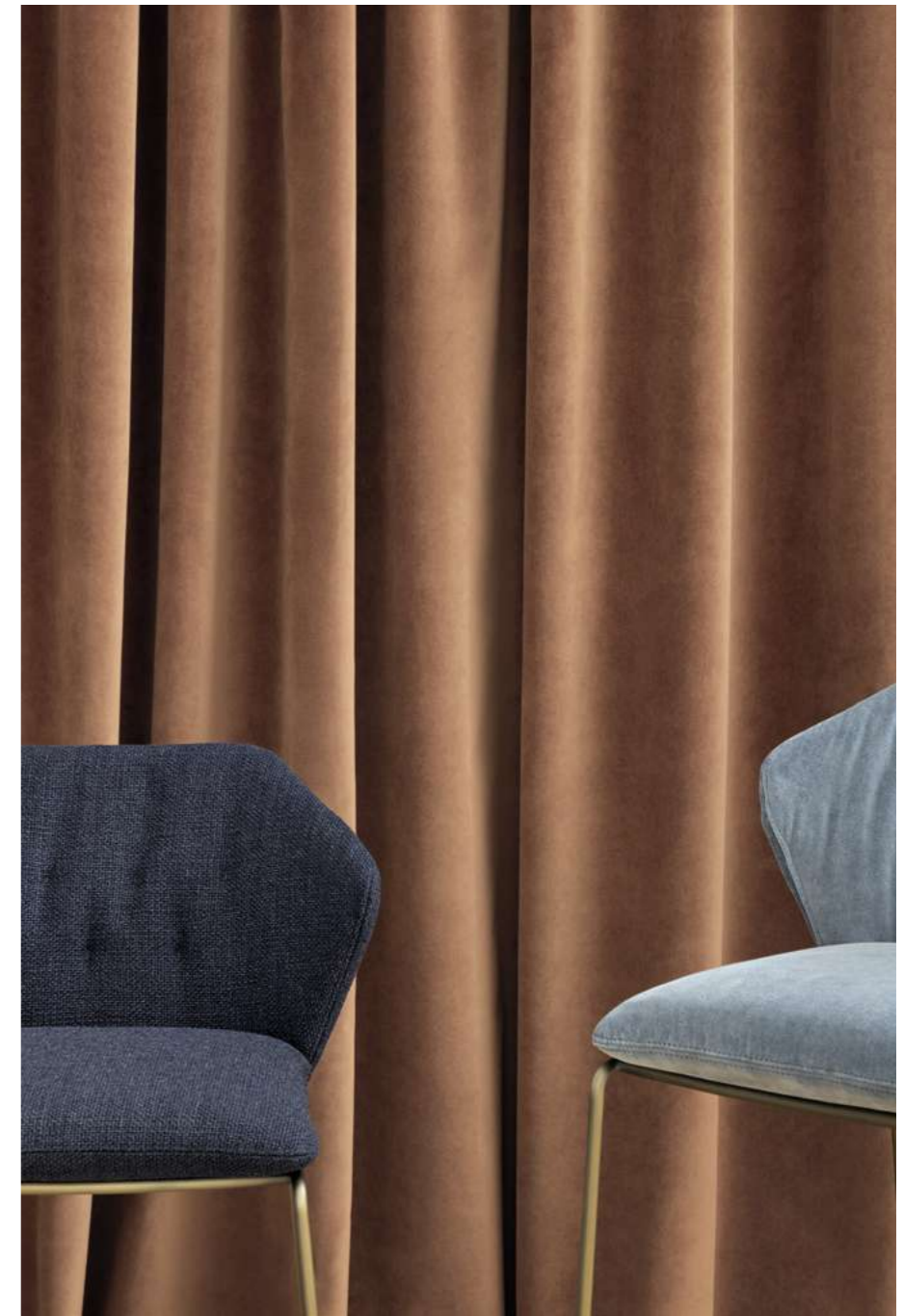

Sgabello basso 53×53 cm
in tessuto Tundra 01 col.21
Sgabello alto 53×53 cm
in tessuto Violet col.08

Low stool 53×53 cm
in fabric Tundra 01 col.21
High stool 53×53 cm
in fabric Violet col.08

Tabouret basse 53×53 cm
en tissu Tundra 01 col.21
Tabouret haut 53×53 cm
en tissu Violet col.08

Taburete bajo 53×53 cm
de tela Tundra 01 col.21
Taburete alto 53×53 cm
de tela Violet col.08

design Sergio Bicego
production year 2020

technical data
p. 502

New York Chair by Marras





Sedie con braccioli 59x54 cm
in tessuto Volti by Marras
dis.3 & dis.4
Sedie 56x54 cm in tessuto
Volti by Marras dis.1 & dis.2

Chairs with armrests 59x54 cm
in fabric Volti by Marras
dis.3 & dis.4
Chairs 56x54 cm in fabric
Volti by Marras dis.1 & dis.2

Chaises avec accoudoirs 59x54 cm
en tissu Volti by Marras
dis.3 & dis.4
Chaises 56x54 cm en tissu
Volti by Marras dis.1 & dis.2

Sillas con brazos 59x54 cm
de tela Volti by Marras
dis.3 & dis.4
Sillas 56x54 cm de tela
Volti by Marras dis.1 & dis.2





design T.S.P.
(Resp. Nicola Pavan)
production year 2020

technical data
pp. 506, 507

Ola Chair Ola Stool





Sedie con braccioli
62x59 cm in tessuto
Violet col.15

Chairs with armrests
62x59 cm in fabric
Violet col.15

Chaises avec
accoudoirs 62x59 cm
en tissu Violet col.15

Sillas con brazos
62x59 cm de tela
Violet col.15



Sedie 54x59 cm
in tessuto Violet col.29

Chairs 54x59 cm
in fabric Violet col.29

Chaises 54x59 cm
en tissu Violet col.29

Sillas 54x59 cm
de tela Violet col.29



Sgabello basso 46x52 cm
in tessuto Seventy col.01
Sgabello alto 46x52 cm
in tessuto Seventy col.90

Low stool 46x52 cm
in fabric Seventy col.01
High stool 46x52 cm
in fabric Seventy col.90

Tabouret basse 46x52 cm
en tissu Seventy col.01
Tabouret haut 46x52 cm
en tissu Seventy col.90

Taburete bajo 46x52 cm
de tela Seventy col.01
Taburete alto 46x52 cm
de tela Seventy col.90



design T.S.P.
production year 2018/2020

technical data
pp. 508, 509

Isabelle Chair Isabelle Stool



(p. 308)

Sedie 60x55 cm
in tessuto Seventy col.90
e Lario col.2003
Sedia 60x55 cm
in tessuto Seventy col.72
e Sweet Velvet col.126

Chairs 60x55 cm
in fabric Seventy col.90
and Lario col.2003
Chair 60x55 cm
in fabric Seventy col.72
and Sweet Velvet col.126

Chaises 60x55 cm
en tissu Seventy col.90
et Lario col.2003
Chaise 60x55 cm
en tissu Seventy col.72
et Sweet Velvet col.126

Sillas 60x55 cm
de tela Seventy col.90
y Lario col.2003
Silla 60x55 cm
de tela Seventy col.72
y Sweet Velvet col.126

Sgabelli 51x49 cm
in tessuto Clean col.05
e col.06

Stools 51x49 cm
in fabric Clean col.05
and col.06

Tabourets 51x49 cm
en tissu Clean col.05
et col.06

Taburetes 51x49 cm
de tela Clean col.05
y col.06



Beds & Sofa Beds



314	Pixel Box Large
314	Pixel Box
324	Pixel Air
330	New York Air
330	New York Box
338	Limes Large
338	Limes
338	Limes T Large
348	Avant-Après
356	Bed & Breakfast

design Sergio Bicego
production year 2019

technical data
pp. 513, 514

Pixel Box Large Pixel Box







318

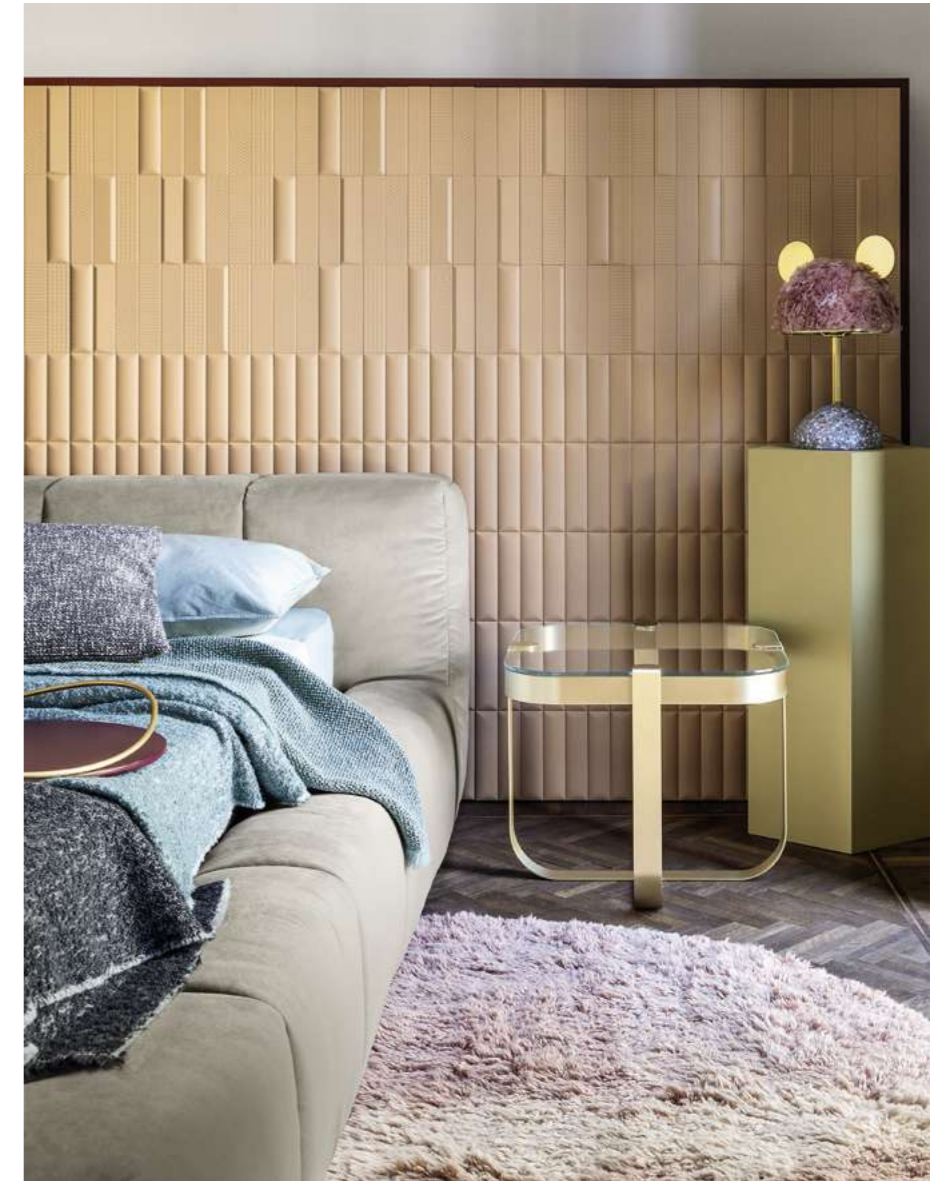

Letto 210×251 cm
in tessuto
Sweet Velvet col.144
Tavolino Ring

Bed 210×251 cm
in fabric
Sweet Velvet col.144
Ring low table

Lit 210×251 cm
en tissu
Sweet Velvet col.144
Table basse Ring

Cama 210×251 cm
de tela
Sweet Velvet col.144
Mesa de centro Ring

319

Letto 194x233 cm
in tessuto
Sweet Velvet col.144
Poltrona Geo
Tavolino Ring

Bed 194x233 cm
in fabric
Sweet Velvet col.144
Geo armchair
Ring low table

Lit 194x233 cm
en tissu
Sweet Velvet col.144
Fauteuil Geo
Table basse Ring

Cama 194x233 cm
de tela
Sweet Velvet col.144
Sillón Geo
Mesa de centro Ring







design Sergio Bicego
production year 2019

technical data
p. 515

Pixel Air

Letto 170×229 cm
in pelle
Enchant col.14 Seppia
Tavolino Leyva
Tavolino Ring
Consolle Hexa
Pouf Geo

Bed 170×229 cm
in leather
Enchant col.14 Seppia
Leyva low table
Ring low table
Hexa console
Geo pouf

Lit 170×229 cm
en cuir
Enchant col.14 Seppia
Table basse Leyva
Table basse Ring
Console Hexa
Pouf Geo

Cama 170×229 cm
de piel
Enchant col.14 Seppia
Mesa de centro Leyva
Mesa de centro Ring
Consola Hexa
Puf Geo





Letto 170×229 cm
in pelle
Enchant col.15 Pietra

Bed 170×229 cm
in leather
Enchant col.15 Pietra

Lit 170×229 cm
en cuir
Enchant col.15 Pietra

Cama 170×229 cm
de piel
Enchant col.15 Pietra



design Sergio Bicego
production year 2018

technical data
pp. 516, 517

New York Air New York Box



Letto 203x225 cm
in tessuto Lario col.58
Poltrona Amélie
Tavolini Più
Tavolino Ring

Bed 203x225 cm
in fabric Lario col.58
Amélie armchair
Più low tables
Ring low table

Lit 203x225 cm
en tissu Lario col.58
Fauteuil Amélie
Tables basses Più
Table basse Ring

Cama 203x225 cm
de tela Lario col.58
Sillón Amélie
Mesas de centro Più
Mesa de centro Ring





Letto 203x225 cm
in tessuto Lario col.58
Pouf Island
Tavolino Più
Tavolino Leyva

Bed 203x225 cm
in fabric Lario col.58
Island pouf
Più low table
Leyva low table

Lit 203x225 cm en tissu
Lario col.58
Pouf Island
Table basse Più
Table basse Leyva

Cama 203x225 cm
de tela Lario col.58
Puf Island
Mesa de centro Più
Mesa de centro Leyva



design Sergio Bicego
production year 2018

technical data
pp. 518, 520, 522

Limes Large Limes Limes T Large



(p. 338)

Letto 199×240 cm
in tessuto
Avant Après col.18
Tavolini Più
Tavolino Leyva

Bed 199×240 cm in fabric
Avant Après col.18
Più low tables
Leyva low table

Lit 199×240 cm en tissu
Avant Après col.18
Tables basses Più
Table basse Leyva

Cama 199×240 cm de tela
Avant Après col.18
Mesas de centro Più
Mesa de centro Leyva

Letto 174×215 cm
in tessuto
Avant Après col.18
Tavolino Più
Tavolino Ring

Bed 174×215 cm in fabric
Avant Après col.18
Più low table
Ring low table

Lit 174×215 cm en tissu
Avant Après col.18
Table basse Più
Table basse Ring

Cama 174×215 cm de tela
Avant Après col.18
Mesa de centro Più
Mesa de centro Ring



Letto 174x240 cm in tessuto
Avant Après col.18
Pouf Geo

Bed 174x240 cm in fabric
Avant Après col.18
Geo pouf

Lit 174x240 cm en tissu
Avant Après col.18
Pouf Geo

Cama 174x240 cm de tela
Avant Après col.18
Puf Geo



Letto 174x240 cm in tessuto
Avant Après col.18
Pouf Geo

Lit 174x240 cm en tissu
Avant Après col.18
Pouf Geo

Bed 174x240 cm in fabric
Avant Après col.18
Geo pouf

Cama 174x240 cm de tela
Avant Après col.18
Puf Geo





design Sergio Bicego
production year 2019

technical data
p. 524

Avant-Après



Letto 162x214 cm
in tessuto
Avant Après col.17
Tavolini Più
Tavolino Ring
Tavolino Leyva
Pouf Geo

Lit 162x214 cm
en tissu
Avant Après col.17
Tables basses Più
Table basse Ring
Table basse Leyva
Pouf Geo

Bed 162x214 cm
in fabric
Avant Après col.17
Più low tables
Ring low table
Leyva low table
Geo pouf

Cama 162x214 cm
de tela
Avant Après col.17
Mesas de centro Più
Mesa de centro Ring
Mesa de centro Leyva
Puf Geo







design Giuseppe Viganò
production year 2011

technical data
p. 525

Bed & Breakfast



Divano 200x105 cm
in tessuto Melange col.02
Poltroncina Baby Geo
Tavolini e libreria Leyva
Tavolino Più

Sofa 200x105 cm
in fabric Melange col.02
Small armchair Baby Geo
Leyva low tables and bookcase
Più low table

Canapé 200x105 cm
en tissu Melange col.02
Petit fauteuil Baby Geo
Tables basses et bibliothèque Leyva
Table basse Più

Sofá 200x105 cm
de tela Melange col.02
Pequeño sillón Baby Geo
Mesas de centro y librería Leyva
Mesa de centro Più



Letto 200x140 cm
in tessuto Melange col.02
Poltroncina Baby Geo
Tavolini e libreria Leyva
Tavolino Più

Bed 200x140 cm
in fabric Melange col.02
Small armchair Baby Geo
Leyva low tables and bookcase
Più low table

Lit 200x140 cm
en tissu Melange col.02
Petit fauteuil Baby Geo
Tables basses et bibliothèque Leyva
Table basse Più

Cama 200x140 cm
de tela Melange col.02
Pequeño sillón Baby Geo
Mesas de centro y librería Leyva
Mesa de centro Più





Divano-letto 200x105/140 cm
in tessuto Melange col.02
Tavolino Più

Sofa-bed 200x105/140 cm
in fabric Melange col.02
Più low table

Canapé-lit 200x105/140 cm
en tissu Melange col.02
Table basse Più

Sofá-cama 200x105/140 cm
de tela Melange col.02
Mesa de centro Più



Low Tables & Furnitures



- 366 Hexa
- 370 Hexa Consolle
- 372 Haiku
- 376 Leyva
- 382 Ring Table
- 386 Ziggy
- 390 Più Table
- 392 Shade

design Enzo Berti
production year 2019

technical data
p. 526

Hexa





(p. 366)

Tavolino tondo
48 cmTable basse ronde
48 cmRound low table
48 cmMesa de centro redonda
48 cmTavolino ovale
120x80 cm
Tavolini tondi
48 cm e 84 cmOval low table
120x80 cm
Round low tables
48 cm and 84 cmTable basse ovale
120x80 cm
Tables basses rondes
48 cm et 84 cmMesa de centro óvalo
120x80 cm
Mesas de centro redondas
48 cm y 84 cm

368



369

design Enzo Berti
production year 2019

technical data
p. 526

Hexa Console



Consolle
140x42 cm

Console
140x42 cm

Console
140x42 cm

Consola
140x42 cm

design Marco Zito
production year 2014

technical data
p. 528

Haiku



Tavolini
70x35 cm
e 70x70 cm

Low tables
70x35 cm
and 70x70 cm

Table basses
70x35 cm
et 70x70 cm

Mesas de centro
70x35 cm
y 70x70 cm

374



375

design Giuseppe Viganò
production year 2007/2016

technical data
p. 530

Leyva



Libreria pensile
150x150 cm

Bibliothèque suspendue
150x150 cm

Wall bookcase
150x150 cm

Librería colgante
150x150 cm

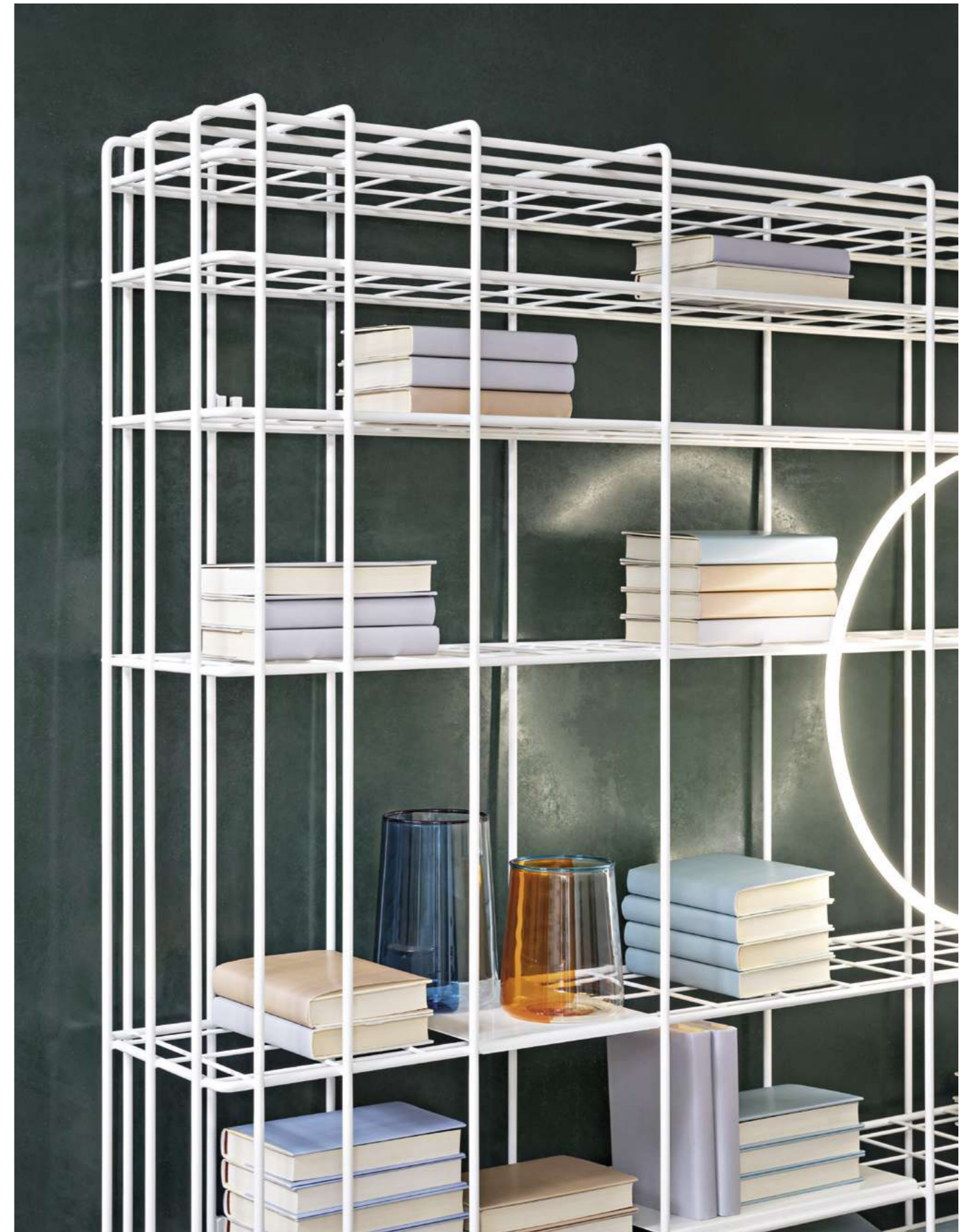
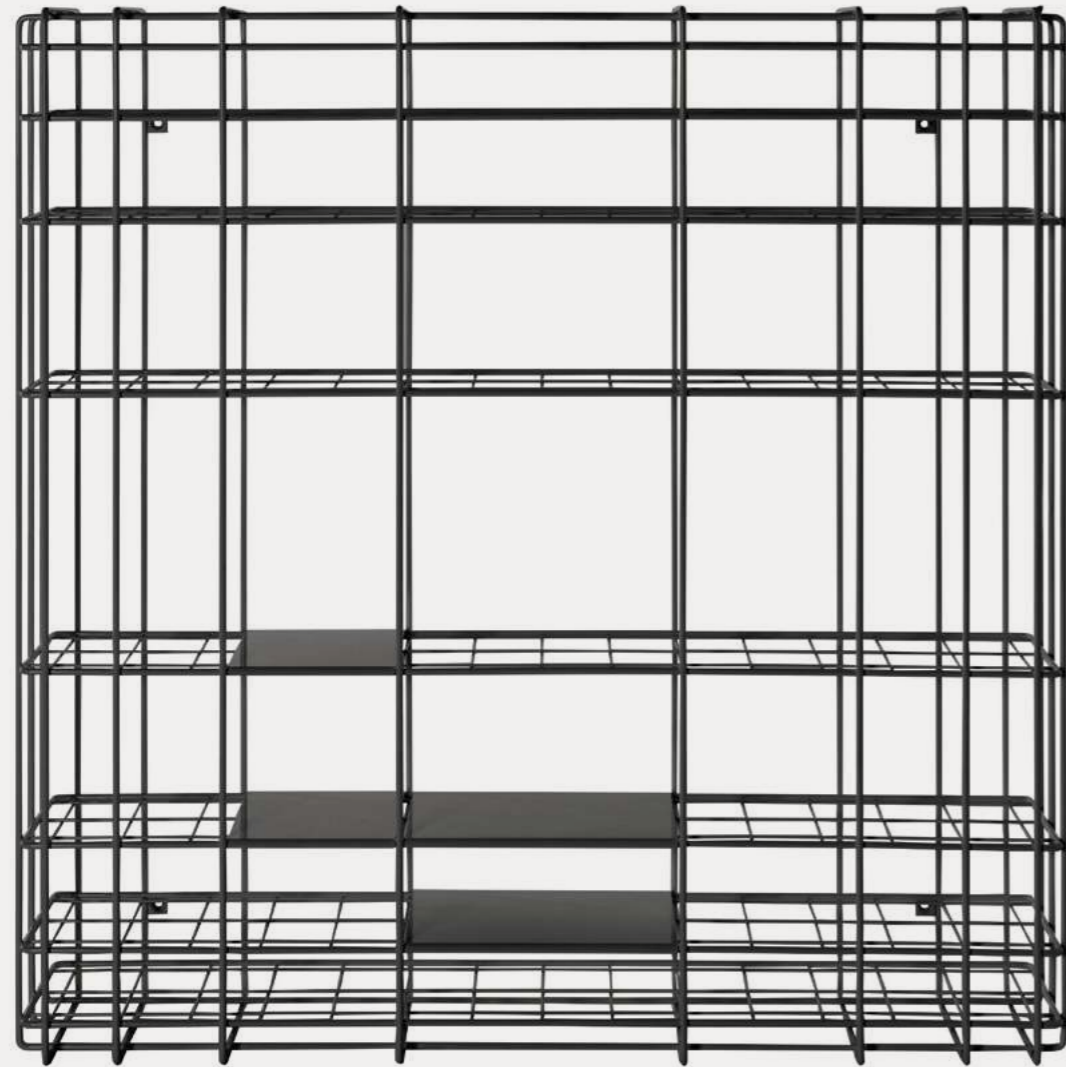

Libreria alta
 150x210 cm
 High bookcase
 150x210 cm
 Bibliothèque haute
 150x150 cm
 Librería alta
 150x150 cm

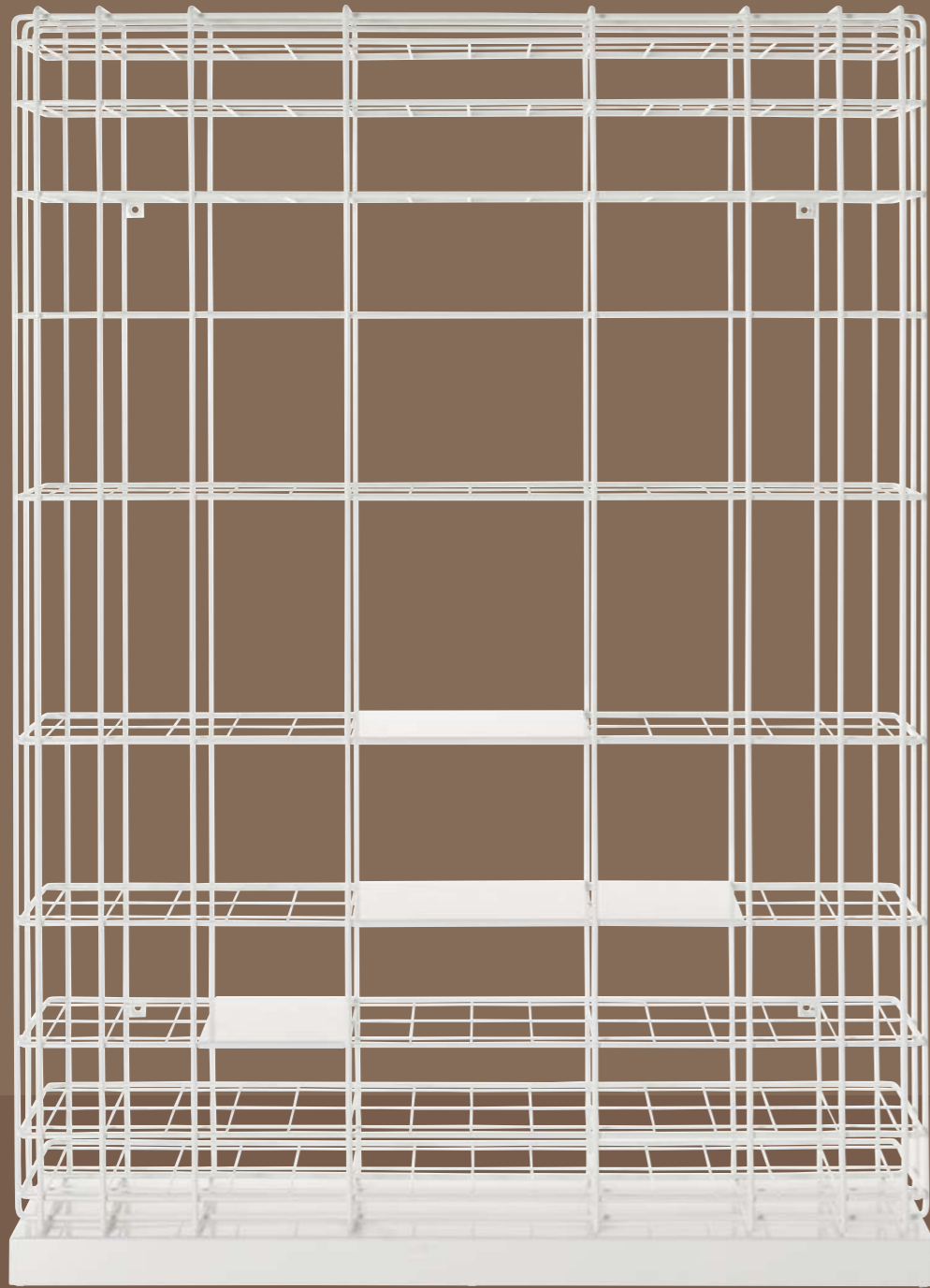

design Serena Confalonieri
production year 2018

technical data
p. 532

Ring Table



Tavolino ovale 100×58 cm
 Tavolino tondo 48 cm
 Tavolino ottagonale 67×67 cm
 Tavolino quadrato 53×53 cm

Oval low table 100×58 cm
 Round low table 48 cm
 Octagonal low table 67×67 cm
 Square low table 53×53 cm

Table basse ovale 100×58 cm
 Table basse ronde 48 cm
 Table basse octogonale 67×67 cm
 Table basse carrée 53×53 cm

Mesa de centro óvalo 100×58 cm
 Mesa de centro redonda 48 cm
 Mesa de centro octogonal 67×67 cm
 Mesa de centro cuadrada 53×53 cm



design Emilio Nanni
production year 2014

technical data
p. 534

Ziggy



(p. 386)

Tavolini e pouf
44x44 cm
Poltrona Chance

Low tables and pouf
44x44 cm
Chance armchair

Tables basses et pouf
44x44 cm
Fauteuil Chance

Mesas de centro y puf
44x44 cm
Sillón Chance



design Giuseppe Viganò
production year 2009

technical data
p. 536

Più Table



Tavolini 40 cm,
50 cm e 82 cm

Low tables 40 cm,
50 cm and 82 cm

Tables basses 40 cm,
50 cm et 82 cm

Mesas de centro 40 cm,
50 cm y 82 cm

Shade



Paraventi bassi 130x140cm
in tessuto F961 col.02 e AT192 col.01
Paraventi alti 130x190 cm
in tessuto F961 col.01 e AT192 col.14

Low dividers 130x140 cm
in fabric F961 col.02 and AT192 col.01
High dividers 130x190 cm
in fabric F961 col.01 and AT192 col.14

Paravents bas 130x140 cm
en tissu F961 col.02 et AT192 col.01
Paravents hauts 130x190 cm
en tissu F961 col.01 et AT192 col.14

Biombos bajos 130x140 cm
de tela F961 col.02 y AT192 col.01
Biombos altos 130x190 cm
de tela F961 col.01 y AT192 col.14



Outdoor

- 396 New York Soleil
- 410 Garden Table
- 412 Shades of Venice
- 416 Ziggy
- 420 Geo Pouf Outdoor
- 424 New York Outdoor
- 428 Grace

design Sergio Bicego
production year 2018/2020

technical data
p. 538

New York Soleil



Poltrona lounge 145x122 cm
in tessuto Frame col.01
Sedie con braccioli 59x54 cm
in tessuto 1536 col.08
Tavolino Garden
Tavolini e pouf Ziggy
Paravento Shade of Venice

Lounge armchair 145x122 cm
in fabric Frame col.01
Chairs with armrests 59x54 cm
in fabric 1536 col.08
Garden low table
Ziggy low tables and pouf
Shade of Venice divider

Lounge fauteuil 145x122 cm
en tissu Frame col.01
Chaises avec accoudoirs 59x54 cm
en tissu 1536 col.08
Table basse Garden
Tables basses et pouf Ziggy
Paravent Shade of Venice

Lounge sillón 145x122 cm
de tela Frame col.01
Sillas con brazos 59x54 cm
de tela 1536 col.08
Mesa de centro Garden
Mesas de centro y puf Ziggy
Biombo Shade of Venice



Poltrona lounge
145x122 cm
in tessuto Frame col.01

Lounge fauteuil
145x122 cm
en tissu Frame col.01

Lounge armchair
145x122 cm
in fabric Frame col.01

Lounge sillón
145x122 cm
de tela Frame col.01





Divano 139x79 cm
in tessuto 1537 col.07
Poltrona 74x79 cm
Tavolino Garden
Paravento Shade of Venice

Sofa 139x79 cm
in fabric 1537 col.07
Armchair 74x79 cm
Garden low table
Shade of Venice divider

Canapé 139x79 cm
en tissu 1537 col.07
Fauteuil 74x79 cm
Table basse Garden
Paravent Shade of Venice

Sofá 139x79 cm
de tela 1537 col.07
Sillón 74x79 cm
Mesas de centro Garden
Biombo Shade of Venice

Poltrona 74x79 cm
in tessuto 1537 col.13
Pouf 58x50 cm

Fauteuil 74x79 cm
en tissu 1537 col.13
Pouf 58x50 cm

Armchair 74x79 cm
in fabric 1537 col.13
Pouf 58x50 cm

Sillón 74x79 cm
de tela 1537 col.13
Puf 58x50 cm

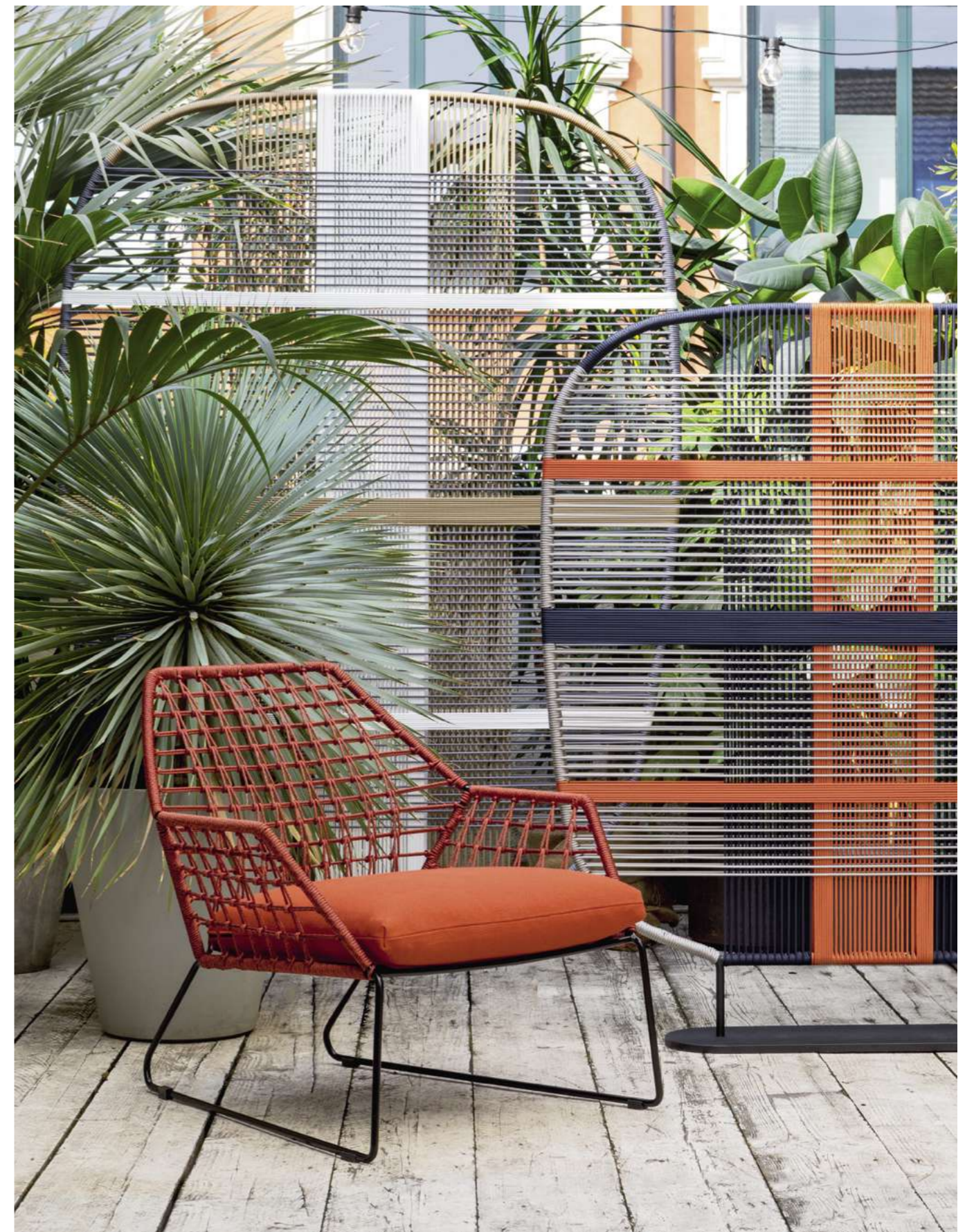



Sgabello alto e basso
53x53 cm in tessuto
Gatsby 1389 col.04

Tabouret haut et basse
53x53 cm en tissu
Gatsby 1389 col.04

High and low stool
53x53 cm in fabric
Gatsby 1389 col.04

Taburete alto y bajo
53x53 cm de tela
Gatsby 1389 col.04

Sedia 56x54 cm
in tessuto 1537 col.06
Tavolo Garden
Paravento Shade of Venice

Chaise 56x54 cm
en tissu 1537 col.06
Table Garden
Paravent Shade of Venice

Chair 56x54 cm
in fabric 1537 col.06
Garden table
Shade of Venice divider

Silla 56x54 cm
de tela 1537 col.06
Mesa Garden
Biombo Shade of Venice



Sedia con braccioli 59x54 cm
in tessuto 1537 col.11
Sedia 56x54 cm
in tessuto 1537 col.06

Chaise avec accoudoirs
59x54 cm en tissu 1537 col.11
Chaise 56x54 cm
en tissu 1537 col.06

Chair with armrests 59x54 cm
in fabric 1537 col.11
Chair 56x54 cm
in fabric 1537 col.06

Silla con brazos 59x54 cm
de tela 1537 col.11
Silla 56x54 cm
de tela 1537 col.06





design T.S.P.
production year 2018

technical data
p. 540

Garden Table

Tavolini 49 cm e 79 cm
Tavolo tondo 79 cm
Pouf Ziggy
Paravento Shade of Venice

Low tables 49 cm and 79 cm
Round table 79 cm
Ziggy pouf
Shade of Venice divider

Tables basses 49 cm et 79 cm
Table ronde 79 cm
Pouf Ziggy
Paravent Shade of Venice

Mesas de centro 49 cm y 79 cm
Mesa redonda 79 cm
Puf Ziggy
Biombo Shade of Venice

design Marco Zito
production year 2018

technical data
p. 541

Shades of Venice



Paravento alto
130x190 cm Murano
Paravento basso
130x140 cm Burano

Paravent haut
130x190 cm Murano
Paravent bas
130x140 cm Burano

High divider
130x190 cm Murano
Low divider
130x140 cm Burano

Biombo alto
130x190 cm Murano
Biombo bajo
130x140 cm Burano

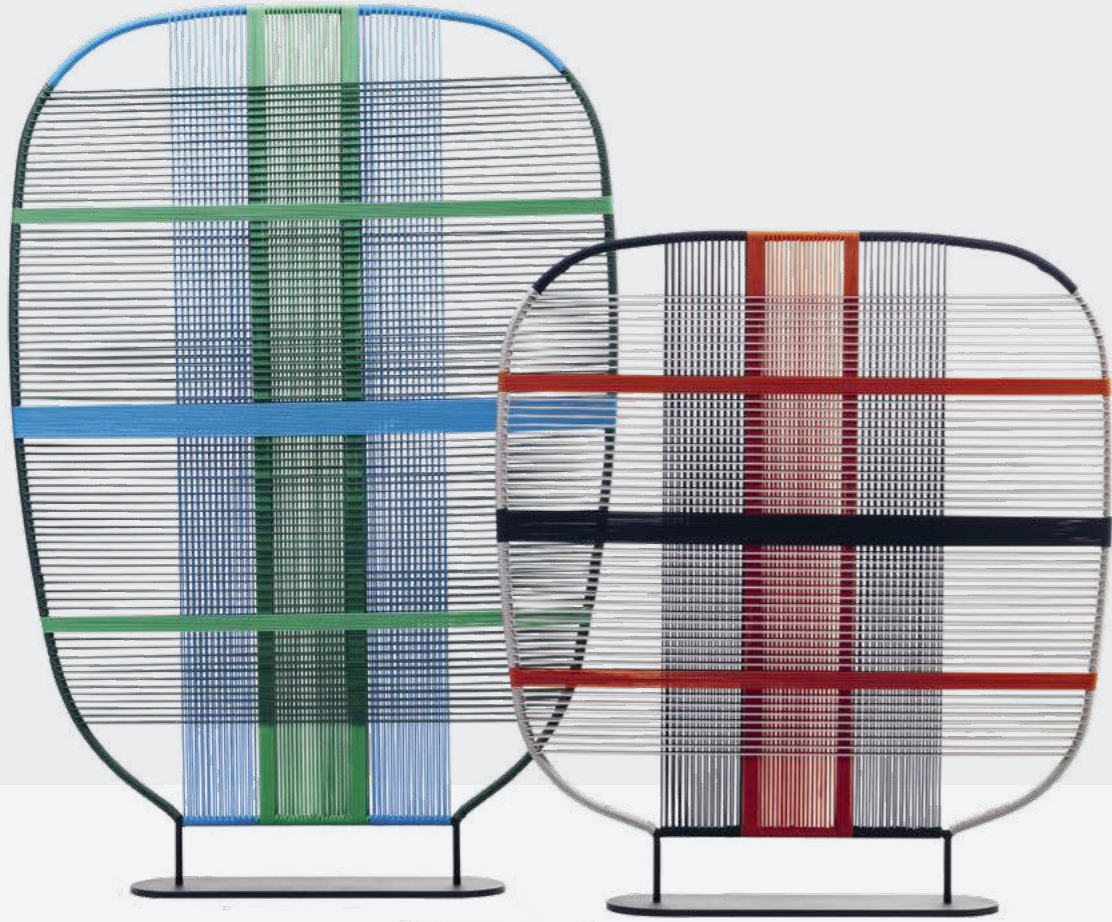

Paravento alto
130x190 cm Giudecca
Paravento basso
130x140 cm Sant'Erasmus

Paravent haut
130x190 cm Giudecca
Paravent bas
130x140 cm Sant'Erasmus

High divider
130x190 cm Giudecca
Low divider
130x140 cm Sant'Erasmus

Biombo alto
130x190 cm Giudecca
Biombo bajo
130x140 cm Sant'Erasmus

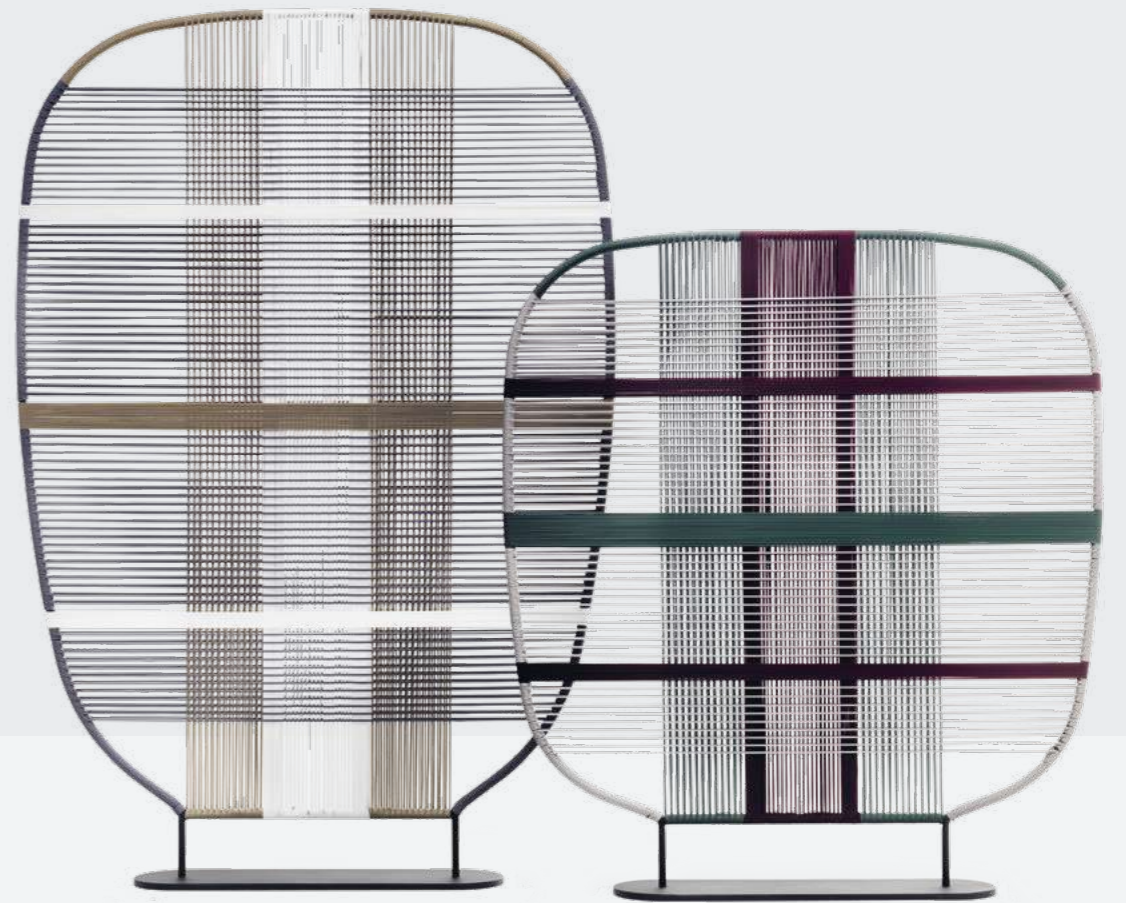

design Emilio Nanni
production year 2014

technical data
p. 542

Ziggy





Tavolini e pouf
44x44 cm

Tables basses et pouf
44x44 cm

Low tables and pouf
44x44 cm

Mesas de centro y puf
44x44 cm

design Paolo Grasselli
production year 2020

technical data
p. 544

Geo Pouf Outdoor



Pouf 60 cm in tessuto
Canvas col.137
Pouf 75 cm in tessuto
Savane col.140
Pouf 90 cm in tessuto
Sunny col.07

Pouf 60 cm in fabric
Canvas col.137
Pouf 75 cm in fabric
Savane col.140
Pouf 90 cm in fabric
Sunny col.07

Pouf 60 cm en tissu
Canvas col.137
Pouf 75 cm en tissu
Savane col.140
Pouf 90 cm en tissu
Sunny col.07

Puf 60 cm de tela
Canvas col.137
Puf 75 cm de tela
Savane col.140
Puf 90 cm de tela
Sunny col.07

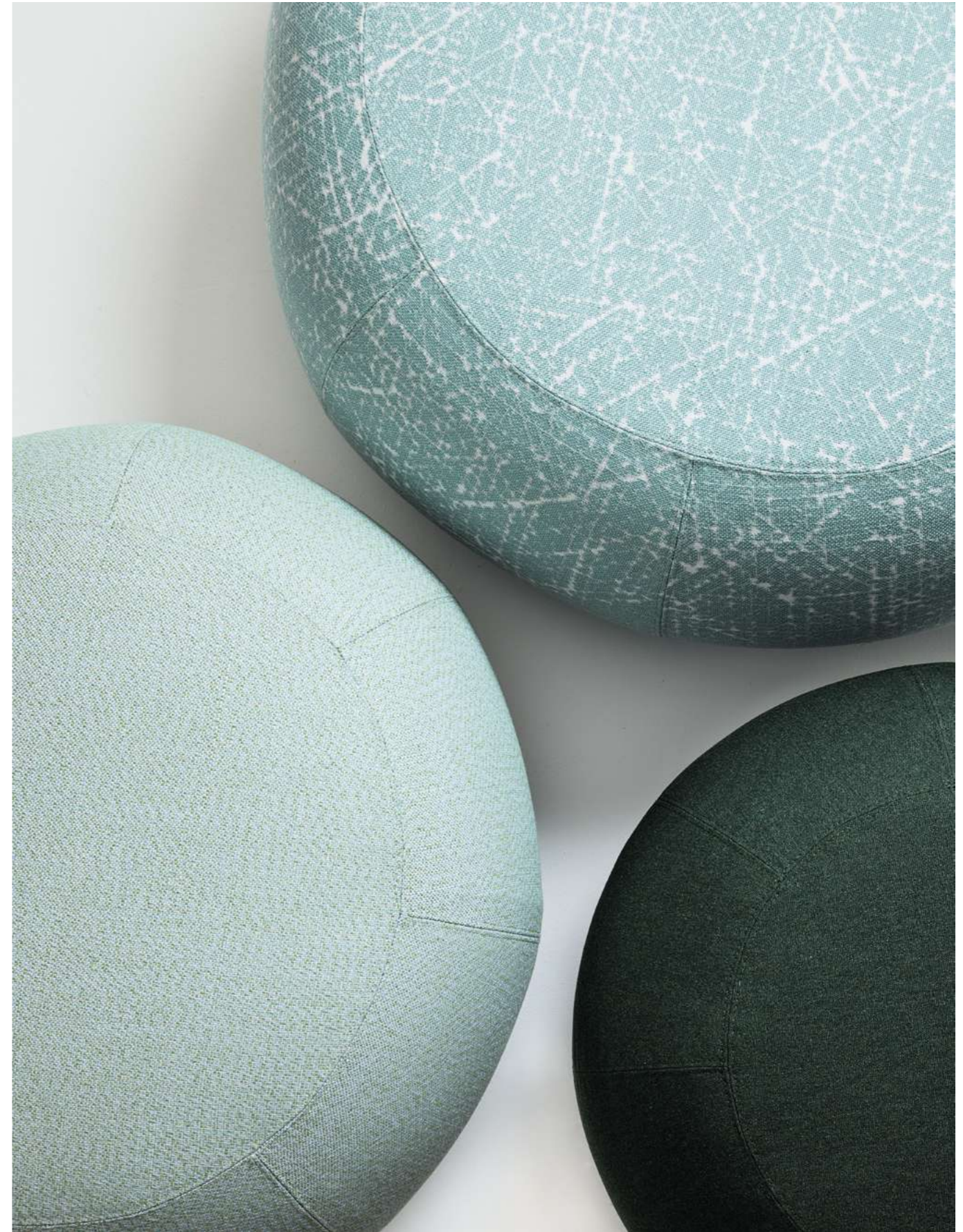

design Sergio Bicego
production year 2013/2017

technical data
p. 545

New York Outdoor



Poltrone 74x83 cm

Armchairs 74x83 cm

Fauteuils 74x83 cm

Sillones de 74x83 cm



426



427



design Paolo Grasselli
production year 2016

technical data
p. 546

Grace





Divano 147×68 cm
e poltrona 86×68 cm
in tessuto 1536 col.08
Tavolino 60×52 cm
Pouf Ziggy

Sofa 147×68 cm
and armchair 86×68 cm
in fabric 1536 col.08
Low table 60×52 cm
Ziggy Pouf

Canapé 147×68 cm
et fauteuil 86×68 cm
en tissu 1536 col.08
Table basse 60×52 cm
Pouf Ziggy

Sofá 147×68 cm
y sillón 86×68 cm
de tela 1536 col.08
Mesa de centro 60×52 cm
Puf Ziggy

Technical data



Index

Sofas

- 434 ● Pixel
 - 438 New York Suite
 - 441 ● My Taos
 - 444 ● Avant-Après
 - 447 ● Ananta Class
 - 450 ● Limes New
 - 452 Voyage
 - 454 Up
 - 456 Essentiel
 - 458 ● Rendez-vous
 - 460 Les Femmes
 - 463 Livingston
 - 466 Geo
 - 468 Philo
 - 470 Kepi
 - 472 New York Dining
 - 473 Quinta Strada
 - 476 Karma
- Armchairs & Poufs
- 478 No Logo Light
 - 479 New York Armchair
 - 480 New York Bergère
 - 481 Geo
 - 482 Baby Geo
 - 483 Chance
 - 484 Chillout
 - 485 Amélie
 - 486 Bustier
 - 487 Essentiel
 - 488 Baby Essentiel
 - 489 Philo
 - 490 Kepi
 - 492 Valentine
 - 493 Livingston
 - 494 Ola
 - 496 Sitar
 - 497 Geo Pouf
 - 498 Island
 - 499 Cookie
 - 500 Pixel Pouf
 - 501 Honey

Chairs & Stools

- 502 New York Chair
- 502 New York Chair by Marras
- 504 New York Dining
- 505 New York Stool
- 506 Ola Chair
- 507 Ola Stool
- 508 Isabelle Chair
- 509 Isabelle Stool

Beds & Sofa Beds

- 513 Pixel Box Large
- 514 Pixel Box
- 515 Pixel Air
- 516 New York Air
- 517 New York Box
- 518 Limes Large
- 520 Limes
- 522 Limes T Large
- 524 Avant-Après
- 525 Bed & Breakfast

Low Tables & Furniture

- 526 Hexa
- 526 Hexa Consolle
- 528 Haiku
- 530 Leyva
- 532 Ring Table
- 534 Ziggy
- 536 Più Table
- 537 Shade

Outdoor

- 538 New York Soleil
- 540 Garden Table
- 541 Shades of Venice
- 542 Ziggy
- 544 Geo Pouf Outdoor
- 545 New York Outdoor
- 546 Grace

● *Modular System Sofas*

— All products are available for Contract Solutions

it — Nato dalla creatività di Sergio Bicego, il divano Pixel è caratterizzato da una serie di elementi che si combinano liberamente tra loro, sfruttando un esclusivo innesto creato da Saba Italia. È così possibile scomporre i braccioli e gli schienali dalle basi per creare nuove composizioni in assoluta libertà. Le sedute in piuma sono caratterizzate dalla particolare cucitura trapuntata, che evidenzia le infinite possibilità di combinare i tessuti della collezione Saba per creare ogni volta un divano unico e personalissimo. Grazie alla particolare forma degli schienali e dei braccioli, le dimensioni complessive del divano risultano sempre molto contenute, sia in larghezza che in profondità, senza penalizzare l'estetica. Il divano Pixel è stato accuratamente concepito in base ai criteri di ergonomia, per avere il massimo comfort su un prodotto altamente ricercato dal punto di vista stilistico. Completamente sfoderabile.

en — The Pixel sofa is characterized by a series of elements which can be combined freely using an exclusive connector made by Saba Italia. The arm and back rests can be detached from the base to create endless new arrangements. The feather-padded seat cushions can be upholstered with a patchwork cover highlighting the limitless possibilities of personalization when choosing a Saba sofa. Thanks to the particular shape of the back and arm rests, the overall size of the sofa is small, both in terms of width and depth, without compromising its aesthetics. The Pixel sofa has been carefully and ergonomically designed to provide the greatest comfort and a highly stylish product. Fully removable covers.

fr — Fruit de la créativité de Sergio Bicego, le canapé Pixel est caractérisé par une série d'éléments qui se combinent librement entre eux, en exploitant un système d'accrochage exclusif créé par Saba Italia. Il est ainsi possible de séparer des bases les accoudoirs et les dossiers pour créer de nouvelles compositions en toute liberté. Les assises garnies de plume sont caractérisées par un matelassage qui souligne les nombreuses combinaisons possibles entre les tissus de la collection Saba, pour créer à chaque fois un canapé unique et très personnel. Grâce à la forme particulière des dossiers et des accoudoirs, les dimensions générales du canapé sont toujours très contenues, aussi bien en largeur qu'en profondeur, sans en pénaliser l'esthétique. Le canapé Pixel a été soigneusement conçu suivant des critères d'ergonomie, pour assurer le plus grand confort à un produit très recherché pour son style. Entièrement déhoussable.

es — Fruto de la creatividad de Sergio Bicego, el sofá Pixel se caracteriza por una serie de elementos que se combinan libremente entre ellos, aprovechando de un acoplamiento exclusivo creado por Saba Italia. Es posible separar los brazos y los respaldos de las bases para crear nuevas composiciones en absoluta libertad. Los asientos de pluma se distinguen por la particular costura pespunteada, que pone en evidencia las infinitas posibilidades de combinación de las telas de la colección Saba para crear cada vez un sofá exclusivo y personalizado. Gracias a la forma particular de los respaldos y de los brazos, la anchura y la profundidad del sofá resultan siempre muy reducidas sin penalizar el aspecto estético. El sofá Pixel ha sido diseñado con gran precisión respetando los criterios de ergonomía para lograr el máximo confort de un producto muy refinado desde el punto de vista estilístico. Completamente desenfundable.



p. 010

Schienali / Backrests

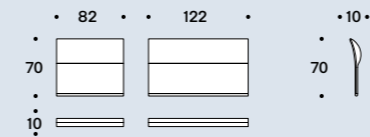

Pouf

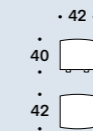

Moduli seduta / Seating units

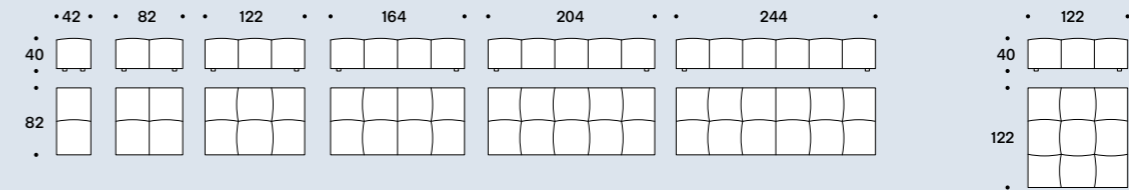

Schienali bracciolo / Backrests armrest

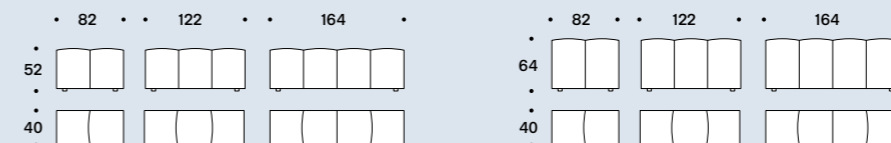

Divani fissi / Fixed sofas

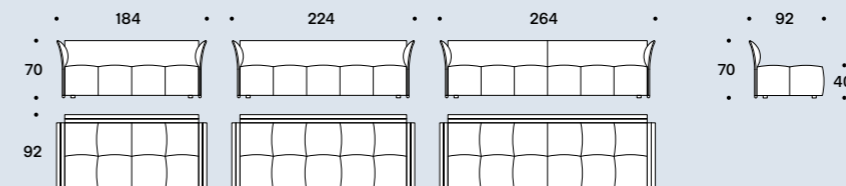

p. 010

Laterali fissi DX-SX / Fixed right-left side units

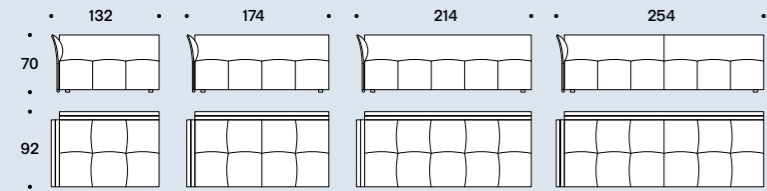

Angoli fissi / Fixed corner units

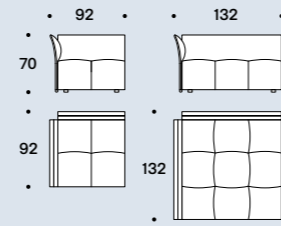

Centrali fissi / Fixed central units

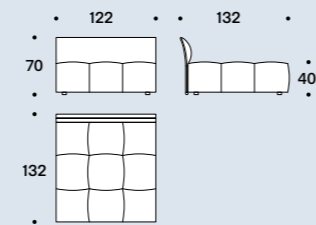
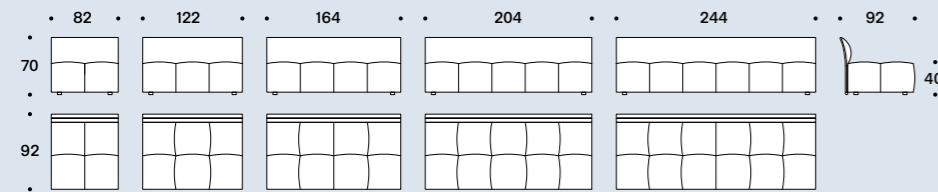

Penisole fisse DX-SX - 174 / Fixed right-left chaise longue - 174

Penisole fisse DX-SX - 214 / Fixed right-left chaise longue - 214

Penisole fisse DX-SX - 254 / Fixed right-left chaise longue - 254

Penisole fisse DX-SX - 132 / Fixed right-left chaise longue - 132

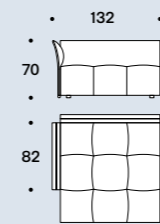
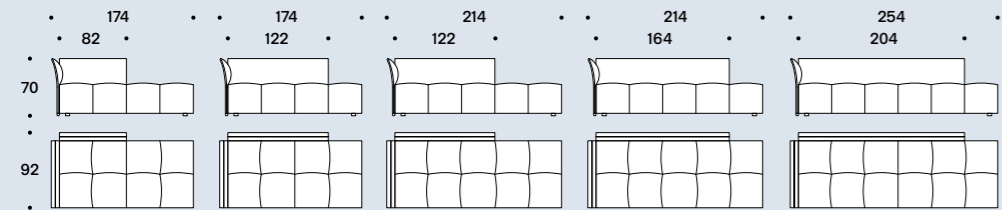

Pouf

Cuscini schiena / Back cushions

Rullo / Roll

Cuscino arredo / Throw cushion

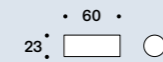
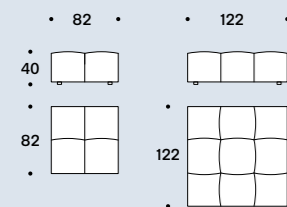

p. 010

Esempi composizioni - 3 moduli seduta da 122 cm, 3 schienali da 82 cm e 2 schienali da 122 cm / Examples of compositions - 3 x 122 cm seating units, 3 x 82 cm backrests and 2 x 122 cm backrests

Moduli sedute / Seating units - 122

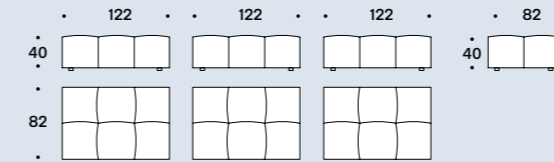

Schienali / Backrests - 82

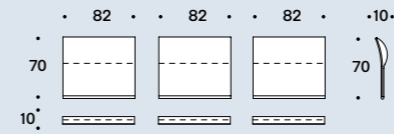

Schienali / Backrests - 122



Esempi / Examples

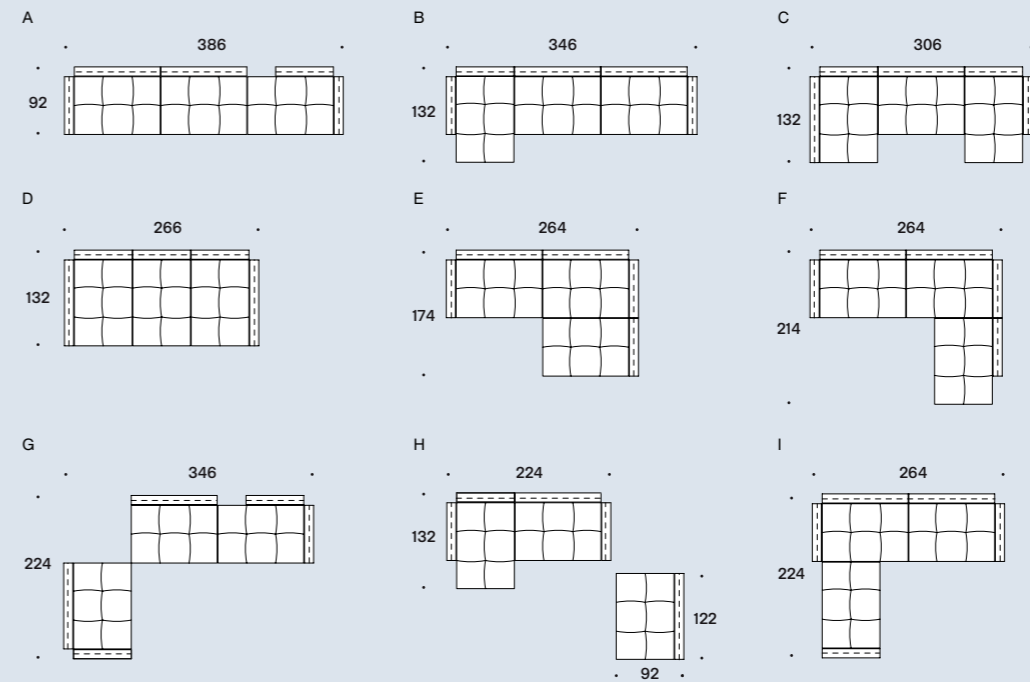

it — La collezione New York firmata Sergio Bicego si declina in nuove forme senza perdere la propria essenza, costituita da un'anima contemporanea e da uno spirito senza tempo. La trapuntatura dei cuscini ammicca a un'eleganza retrò e cede alla tentazione della nostalgia per tratteggiare il design del futuro. Allo stesso tempo l'allure metropolitana viene esaltata dalla sagoma esagonale della struttura, che poggia su piedi sottili in tondino di acciaio. New York Suite è avvolgente e ospitale anche nelle varianti più contenute come la maxi poltrona lounge e il divano da 155 cm, che accoglie morbidamente due persone e risulta particolarmente interessante per il sistema contract. Completamente sfoderabile.

en — The new New York collection designs by Sergio Bicego still retain a contemporary soul and timeless spirit. The quilted cushions hint at a retro elegance and a nostalgic atmosphere yet the whole design is futuristic. At the same time the metropolitan allure is heightened by the hexagonal shape of the frame resting on slim steel rod feet. New York Suite is soft and elcoming also in the smaller versions such as the maxi lounge chair and the 155 cm sofa which seats two people comfortably and is particularly interesting for contract projects. Fully removable covers.

fr — La collection New York signée Sergio Bicego est déclinée dans de nouvelles formes sans perdre son essence, une âme contemporaine et un esprit sans temps. Le matelassage des coussins évoque une élégance rétro et cède à la tentation de la nostalgie pour anticiper le design du futur. En même temps, l'allure métropolitaine est soulignée par le profil hexagonal de la structure, qui repose sur des pieds fins en fil d'acier. New York Suite est enveloppant et accueillant, y compris dans les versions de taille plus réduite comme le maxi fauteuil lounge et le canapé de 155 cm, qui offre deux places confortables et se révèle particulièrement intéressant pour le secteur des collectivités. Entièrement déhoussable.

es — La colección New York firmada por Sergio Bicego se declina en nuevas formas sin perder su esencia, constituida por un alma contemporánea y un espíritu atemporal. El pespunteado de los cojines revela una elegancia retro y cede a la tentación de la nostalgia para delinear el diseño del futuro. A su vez, la esencia metropolitana es exaltada por el perfil hexagonal de la estructura, sujeta por patas delgadas de varilla de acero. New York Suite es envolvente y acogedor también en las variantes más contenidas como el maxi sillón lounge y el sofá de 155 cm, que acoge con delicadeza a dos personas y es particularmente interesante para el sistema contract. Completamente desfundable.

p. 030

Divani / Sofas

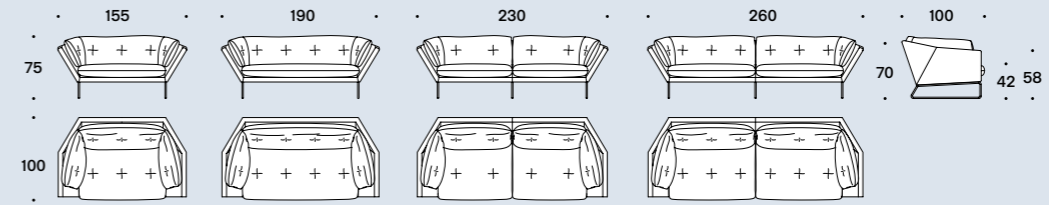

Laterali DX-SX / Right-left side units

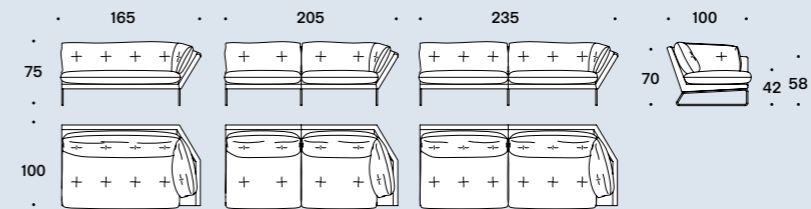

Penisole DX-SX / Right-left chaise longue

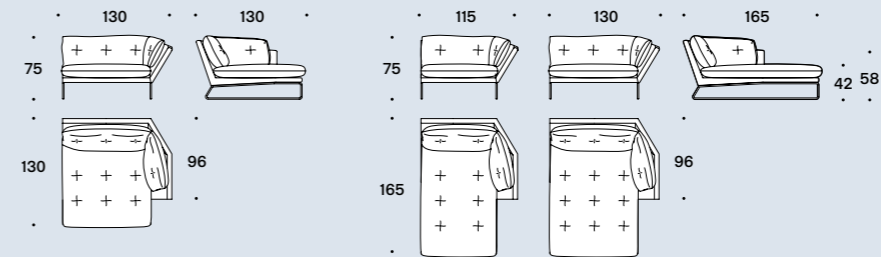

Poltrona lounge / Lounge armchair

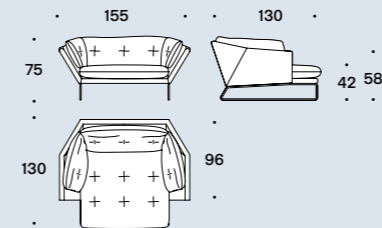

Pouf

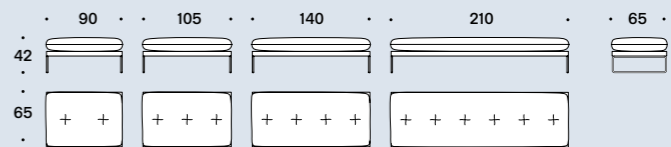

Finitura piedi / Feet finish

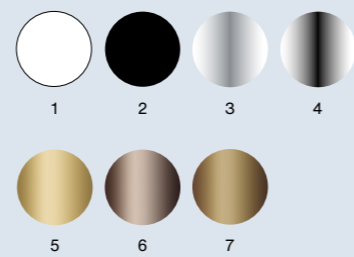

- 1 Bianco / White / Blanc / Blanco
- 2 Nero / Black / Noir / Negro
- 3 Cromo / Chrome / Chrome / Cromo
- 4 Black nichel / Black nickel / Nickel noir / Niquel negro
- 5 Ottone satinato / Satin brass / Laiton satiné / Latón satinado
- 6 Bronze copper matt
- 7 Bronze gold matt



it – My Taos è il progetto di divano che meglio spiega l'identità Saba. Il lavoro di restyling si è basato sui quattro principi cardine dell'azienda: la memoria, il confort, il design e la poesia. La memoria la si ritrova nel nuovo My Taos nella fedeltà al progetto originale mantenendo lo scorrimento in avanti e indietro dei pouf. Il confort ha riparametrato altezze e migliorato l'ergonomia con l'uso di materiali di ultima generazione. Il design ha ridisegnato nuovi tavoli d'appoggio funzionali e nuovi cuscini cilindrici d'appoggio. La poesia ha arrotondato le forme, smussato spigoli, addolcito le linee. My Taos è il tuo-nostro divano che spiega come un'idea eccellente non si consuma con la fragilità del tempo. Completamente sfoderabile.

en – My Taos is the sofa design that best communicates Saba's identity. Its recent redesign is based on the 4 pillars of the company: memory, comfort, design and poetry. My Taos stays true to its original design by maintaining the element of fluidity in the movement of the pouf structures. Improved comfort has redefined the heights of the back structures and improved the ergonomics using the latest generation of materials. This new design has also altered the fold-out side tables and new cylindrical support cushions. The element of poetry in the updated design has rounded the overall form, softening all edges and lines. My Taos sofa epitomizes how an excellent design stands the test of time. Fully removable covers.

fr – My Taos est le projet de canapé qui reflète le mieux l'identité de Saba. Le travail de restyling s'est fondé sur les quatre principes fondamentaux de l'entreprise : la mémoire, le confort, le design et la poésie. Le principe de mémoire se retrouve dans le nouveau My Taos dans sa fidélité au projet d'origine, dont il conserve la possibilité des poufs de coulisser vers l'avant et vers l'arrière. Le principe de confort est à l'origine d'une nouvelle configuration des hauteurs et de l'amélioration de l'ergonomie qui passe par l'utilisation de matériaux de dernière génération. Le principe de design a donné lieu à la conception de nouvelles tables d'appui fonctionnelles ainsi que de nouveaux coussins d'appui cylindriques. Le principe de poésie a arrondi les formes, émoussé les arêtes et adouci les lignes. My Taos est le canapé de tous, qui explique comment les idées, lorsqu'elles sont excellentes, ne se consomment pas avec la fragilité du temps. Entièrement déhoussable.

es – My Taos es el proyecto de sofá que mejor explica la identidad Saba. El trabajo de remodelación se ha basado en los cuatro principios básicos de la empresa: la memoria, el confort, el diseño y la poesía. La memoria se encuentra en el nuevo My Taos en la fidelidad al proyecto original manteniendo en desplazamiento hacia adelante y atrás del puf. El confort ha baremado de nuevo las alturas y se ha mejorado la ergonomía con el uso de materiales de última generación. El diseño ha rediseñado nuevas mesas de apoyo funcionales y nuevos cojines cilíndricos de apoyo. La poesía ha redondeado las formas, suavizado las aristas y dulcificado las líneas. My Taos es tu-nuestro sofá que explica cómo una idea excelente no se consume debido a la fragilidad del paso del tiempo. Completamente desenfundable.



p. 046

Moduli sedute, pouf / Seating units, pouf

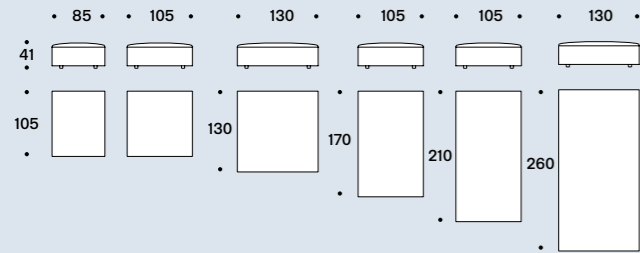

Pouf Terminale DX-SX / Right-left end unit pouf

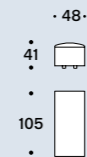

Bracciolo DX-SX / Right-left armrest



Tavolino bracciolo DX-SX / Right-left low table armrest

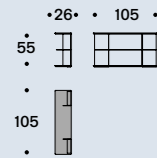

Centrali / Central units

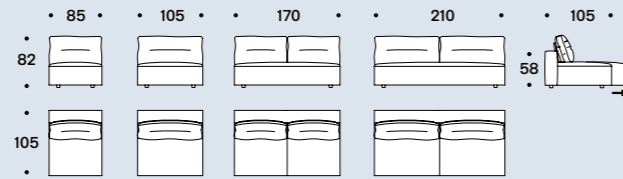

Penisole / Chaise longue

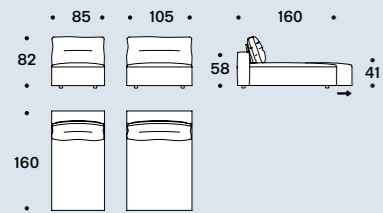

Angolare DX-SX / Right-left corner unit

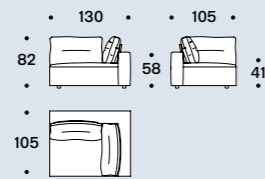

Tavolini / Low tables

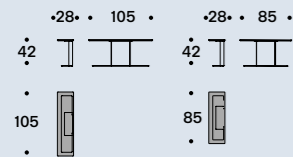

Cuscini schiena / Backrest cushions

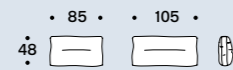

Cuscini rullo / Roll cushions

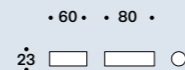

p. 046

Esempi composizioni / Examples of compositions

MYT1&2

Centrale / Central - 170 cm
Base / Base - 130x130 cm
Bracciolo DX / Right armrest - 26 cm
Cuscino schiena / Back cushion - 85 cm
Cuscino rullo / Roll cushion - 60 cm

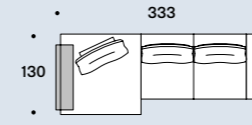

MYT3&4

Centrale / Central - 170 cm
Centrale / Central - 85 cm
Bracciolo DX / Right armrest - 26 cm
Angolare SX / Left Corner unit
Pouf terminale SX / Left end unit pouf

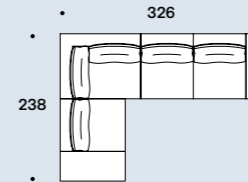

MYT5&6

Centrale / Central - 170 cm
Chaise longue - 85x160 cm
Bracciolo DX-SX / Right - left armrest - 26 cm

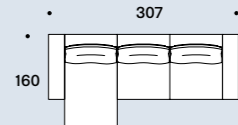

MYT7&8

Centrale / Central - 210 cm
Chaise longue - 160x105 cm
Bracciolo SX / Left armrest - 36 cm
Tavolino bracciolo DX / Right low-table armrest - 26 cm

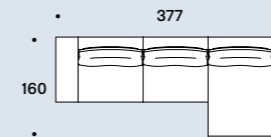

MYT9&10

Centrale / Central - 210 cm
Base / Base - 210x105 cm
Bracciolo DX / Right armrest - 26 cm
Cuscino schiena / Back cushion - 85 cm
Cuscino rullo / Roll cushion - 60 cm

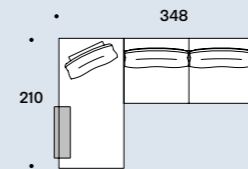

MYT11&12

Centrale / Central - 210 cm
Base / Base - 260x130 cm
Bracciolo DX / Right armrest - 26 cm
Cuscini schiena / Back cushions - 85 cm
Cuscini rullo / Roll cushions - 60 cm

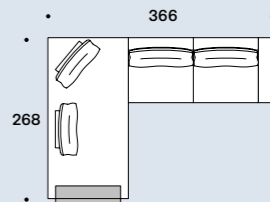

MYT13&14

Base / Base - 260x130 cm
Base / base - 210x105 cm
Cuscini schiena / Back cushions - 85 & 105 cm
Cuscini rullo / Roll cushions - 60 & 80 cm

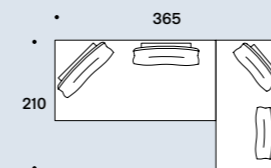

MYT15

Basi / Bases - 105 & 210x105 cm
Centrale / Central - 105 cm
Chaise longue - 160x105 cm
Bracciolo SX / Left armrest - 26 cm
Cuscino schiena / Back cushion - 85 cm
Cuscino rullo / Roll cushion - 60 cm

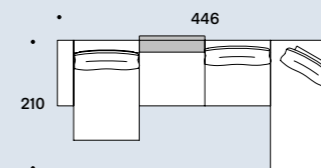

MYT16

Base / Base - 260x130 cm
Cuscini schiena / Back cushions - 105 cm
Cuscini rullo / Roll cushions - 80 cm

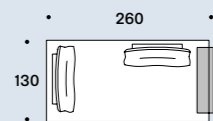

it — Fluire, adattarsi, creare vuoti, riorganizzare spazi, accogliere e rinnovarsi. Questo è ciò che può fare il nuovo sistema di sedute Avant-Après. Rigoroso eppure leggero, il divano assume configurazioni estremamente interessanti grazie al particolare e unico sistema bracciolo/schienale che si stacca con un gesto semplice e si può posizionare lungo tutto il perimetro della base. Una danza al ritmo di un prima e dopo che può essere messa in scena ogni giorno, animata dalla voglia di sperimentare. Avant-Après ha un'allure sobria e un tratto elegante, le sedute sono appoggiate su una base di metallo rivestito in tessuto o in pelle, sollevato da terra su piedi in metallo. Raffinati accessori completano il sistema: i tavolini d'appoggio in due diverse dimensioni sono realizzati in legno noce canaletto. Completamente sfoderabile.

en — Flow, adapt, create void, rearrange space, receive and renew indefinitely. The new Avant-Après seating is able to do it all. Rigid yet lightweight, the sofa comes in fascinating configurations thanks to the special and unique armrest/backrest system that detaches with a simple movement and may be positioned all along the base. A pre-and-post dance that can be staged every day, created by the desire to try something new. Avant-Après has a sober allure and an elegant appearance. The seating is placed on a metal base upholstered in fabric or leather, resting on metal feet. Refined accessories complete the system: the side tables are walnut wood and come in two different sizes. Fully removable covers.

fr — Flotter, s'adapter, créer des vides, réorganiser les espaces, accueillir et se renouveler. Voici ce propose le nouveau système d'assises Avant-après. Rigoureux mais léger, le canapé présente des configurations extrêmement intéressantes grâce à un système spécial et unique d'accoudeur/dossier qui se détache d'un simple geste et peut se positionner tout au long de la base. Une danse au rythme d'un avant et d'un après, animée par la volonté d'expérimenter, qui peut se mettre en scène chaque jour. Avant-Après a une allure sobre et élégante, les assises reposent sur une base en métal revêtu de tissu ou de cuir, soulevée du sol par des pieds en métal. Des accessoires raffinés complètent le système: les petites tables d'appui, disponibles dans deux dimensions différentes, sont réalisées en noyer canaletto. Entièrement déhoussable.

es — Fluir, adaptarse, crear vacíos, reorganizar espacios, acoger y renovarse. Es lo que puede hacer el nuevo sistema de sillas Avant-Après. Riguroso y, sin embargo, ligero, el sofá asume configuraciones extremadamente interesantes gracias al particular y único sistema brazo/respaldo que se separa con un movimiento sencillo y puede colocarse a lo largo de todo el perímetro de la base. Una danza al ritmo de un antes y después que puede ponerse en escena cada día, animada por las ganas de experimentar. Avant-Après tiene un aspecto sobrio y un trazo elegante, los asientos se apoyan sobre una base de metal revestido de tejido o de piel, levantado del suelo por pies de metal. El sistema se complementa con accesorios refinados: las mesas de apoyo, en dos tamaños diferentes, están realizadas en madera nogal canaletto. Totalmente desenfundable.

p. 060

Moduli sedute / Seating units

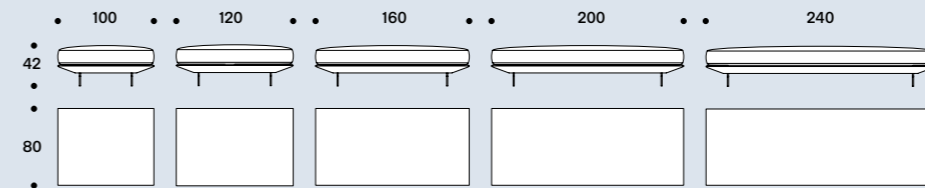

Fianco con schienale / Side backrest

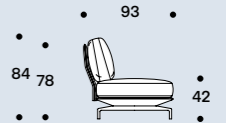

Moduli sedute con bracciolo imbottito / Seating units with padded armrest

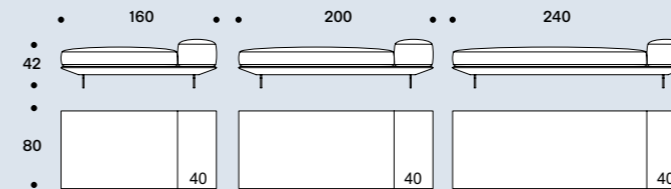

Fianco con schienale / Side backrest

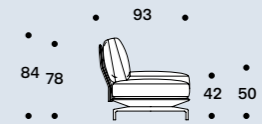

Schienali / Backrests

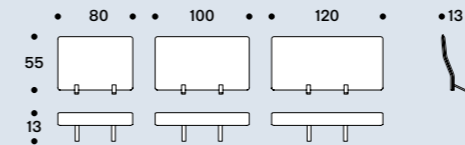

Bracciolo / Armrest

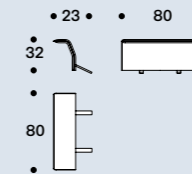

Cuscini schiena / Backrest cushions

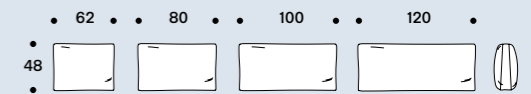

Finitura piedi / Feet finish

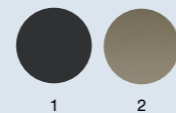

- 1 Grigio / Grey / Gris / Gris
- 2 Verniciato cromo satinato / Painted glazed chrome / Peint chrome satiné / Pintado cromo satinado

Cuscini bracciolo / Armrest cushions



Tavolini / Low tables

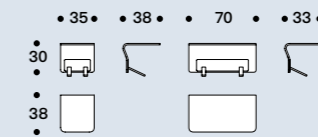

Cuscini arredo / Throw cushions

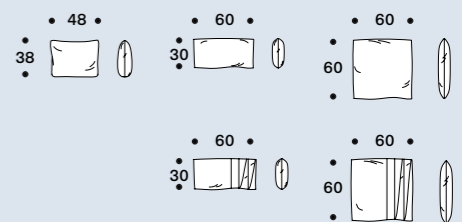

it — Ananta Class è un sistema informale, libero e versatile che permette infinite composizioni grazie agli schienali indipendenti e alle basi da 80, 120, 160, 200 e 240 cm accostabili tra loro. Il progetto, il cui nome rimanda al concetto di infinito, parte dalla semplificazione costruttiva: le sedute, libere dai vincoli dei braccioli e delle schiene, si riorganizzano negli spazi adeguandosi alle esigenze. Il progetto è completato da un tavolino disponibile in due misure. Il supporto con finitura cromo nero sostiene un piano disponibile con impiallacciato noce canaletto o rivestito in cuoio rigenerato. Un modo nuovo, democratico e contemporaneo di subordinare l'oggetto alla centralità dell'uomo. Completamente sfoderabile.

en — Ananta Class is an informal, modular and versatile range that allows endless combinations of the independent backrests and bases available in 80, 120, 160, 200 and 240 cm lengths. The collection, whose name evokes the concept of infinity, is based on the idea of simple construction: free from constraints of the armrests and backrests, the seating can be arranged to suit individual needs. It is completed with a side table available in two sizes. The black chrome structure holds up a table top available in walnut veneer or regenerated leather. The line offers a new, democratic and modern way of relating objects to people's lifestyles. Fully removable covers.

fr — Ananta Class est un système informel, libre et polyvalent, qui permet un nombre illimité de compositions grâce aux dossiers indépendants et aux bases de 80, 120, 160, 200 et 240 cm juxtaposables les unes aux autres. Le projet, dont le nom renvoie au concept d'infini, part de la simplification de la construction: les assises, libérées de la contrainte des accoudoirs et des dossiers, se réorganisent dans les espaces en s'adaptant aux exigences. La proposition est complétée par une table basse, déclinée en deux taille. Le support en finition chrome noir soutient un plateau disponible en bois de noyer plaqué ou recouvert de cuir régénéré. Une nouvelle manière, démocratique et contemporaine de subordonner l'objet à la centralité de l'homme. Entièrement déhoussable.

es — Ananta Class es un sistema informal, libre y versátil, que ofrece infinitas composiciones gracias a los respaldos independientes y a las bases de 80, 120, 160, 200 y 240 cm que pueden adosarse entre ellas. El proyecto evoca el concepto de infinito y parte de la simplificación constructiva: los asientos no tienen vínculos de brazos y respaldos y se reorganizan en los espacios adaptándose a las distintas exigencias. El proyecto se completa con una mesa de centro, disponible en dos medidas. El soporte con acabado cromo negro sostiene un tablero disponible con contrachapado nogal canaletto o revestido de cuero regenerado. Una forma nueva, democrática y contemporánea de subordinar el objeto a la centralidad de la persona. Completamente desenfundable.



p. 076

Bracciolo / Armrest - 15

Schienali / Backrests - 15

Schienali angolari / Corner backrests - 15

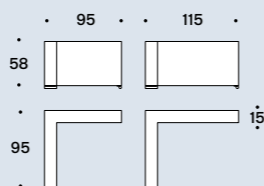
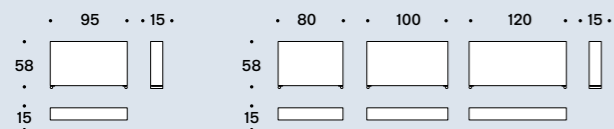

Bracciolo / Armrest - 23

Schienali / Backrests - 23

Schienali angolari / Corner backrests - 23

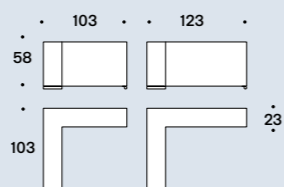
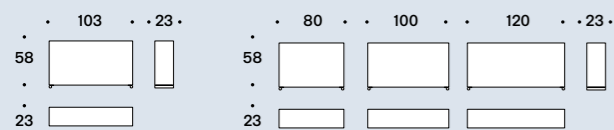

Moduli sedute / Seating units

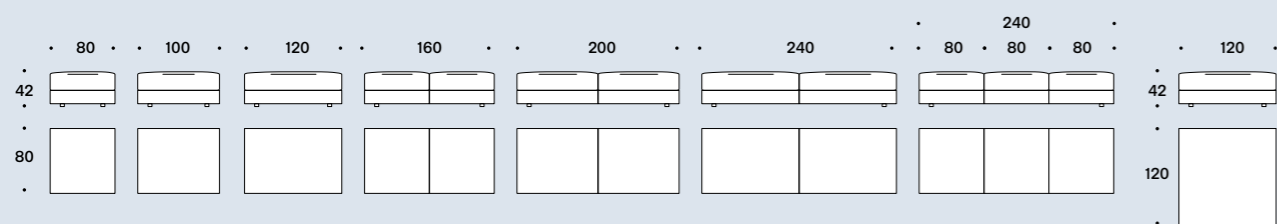

Cuscini schiena / Back cushions

Tavolini / Low tables

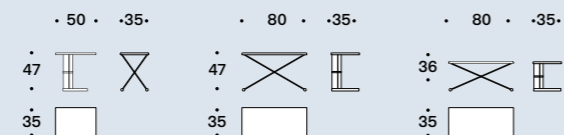
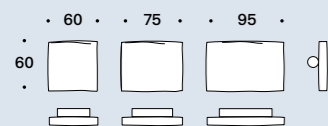

p. 076

Divani fissi / Fixed sofas - 15

Divani fissi / Fixed sofas - 23

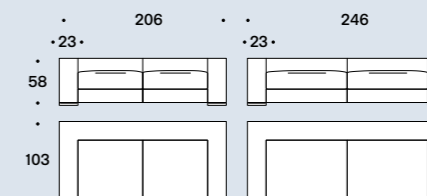
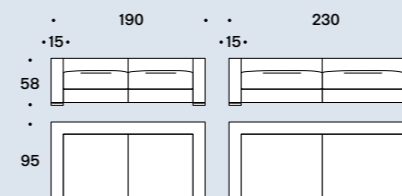

Laterali fissi DX-SX / Fixed right-left side units - 15

Laterali fissi DX-SX / Fixed right-left side units - 23

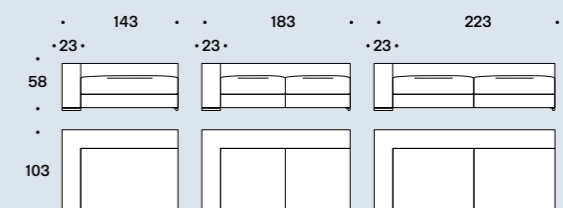
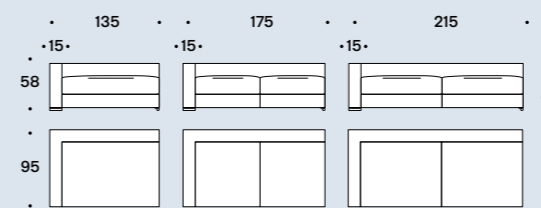

Penisola fissa DX-SX 155 / Fixed right-left chaise longue 155 - 15

Penisola fissa DX-SX 163 / Fixed right-left chaise longue 163 - 23

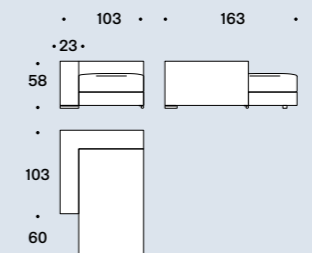
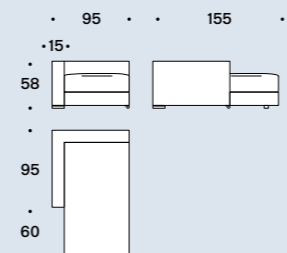

Terminale fisso DX-SX 215 / Fixed right-left end unit 215 - 15

Terminale fisso DX-SX 215 / Fixed right-left end unit 215 - 23

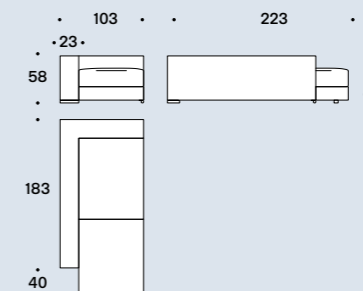
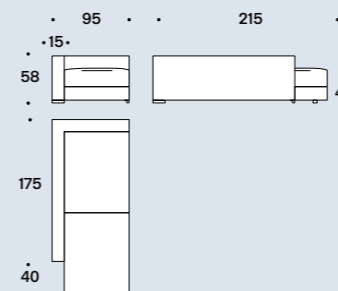

it — Limes New è il divano che testimonia l'approccio filosofico Saba alla nascita di un progetto d'arredo: "tutto scorre, tutto cambia" è la citazione di Parmenide che ha acceso il processo creativo e lo ha guidato nelle fasi di ricerca a partire dai primi anni duemila. Limes New è un invito ad andare oltre le convenzioni di spazio predefinito, perché può diventare altro semplicemente spostando gli appoggi dello schienale. Limes New è una storia da raccontare rinnovata nei dettagli sartoriali e tecnici: il taglio asimmetrico dei cuscini schienale migliora l'appoggio della zona lombare, la ricerca di un nuovo materiale garantisce l'effetto morbido del piumino d'oca e assicura un comfort senza manutenzione, una discreta rivisitazione dei volumi che si armonizza con l'estetica contemporanea e per finire un inedito cilindro da usare come bracciolo in omaggio alla classicità latina. Piedi aerei in metacrilato o in metallo finitura cromata e doppia profondità. Completamente sfoderabile.

en — Limes New is a sofa that upholds Saba's philosophical approach to a larger furnishing project: "Everything slides, everything changes" elaborates Parmenide, who ignited the creative process and guided it through the research phases from the early 2000's. Limes New is an invitation to go beyond the conventions of predefined space, showcasing how it can become something else altogether simply by moving the back rests. Limes New is a story to tell renewed through sartorial and technical detailing: the asymmetric cut of the back cushions improves support in the lower back. Research into new materials allows the sensation of softness from the goose down filling to come through and guarantees a superior comfort. The volumes have been subtly updated in line with the contemporary aesthetic to include cylindrical armrests in homage to the classic latin heritage. Methacrylate or metal chrome finished and double depth floating feet. Fully removable covers.

fr — Limes New est le canapé qui témoigne de l'approche philosophique de Saba lors de la naissance d'un projet d'aménagement : « tout se meut, tout change » est la citation de Parménide qui a lancé le processus créatif et l'a guidé lors des phases de recherche au début des années 2000. Limes New est une invitation à dépasser les conventions d'un espace prédéfini, car il peut se transformer en déplaçant simplement les panneaux de soutien des dossiers. Limes New est une histoire à raconter qui se renouvelle dans les détails techniques et couture : la découpe asymétrique des coussins des dossiers améliore le soutien de la zone lombaire. La recherche d'un nouveau matériau garantit l'effet moelleux des plumes d'oie et assure un confort sans besoin d'entretien. Une réinterprétation discrète des volumes s'harmonise avec l'esthétique contemporaine, tandis qu'un coussin cylindrique inédit peut s'utiliser comme accoudoir, en hommage au classicisme latin. Pieds invisibles en méthacrylate ou en métal finition chromée et double profondeur. Entièrement déhoussable.

es — Limes New es el sofá que resume el enfoque filosófico de Saba en el nacimiento de un proyecto de decoración: « todo corre, todo fluye » es la cita de Parménides que ha encendido el proceso creativo y lo ha guiado en las fases de investigación a principios del nuevo milenio. Limes New es una invitación a ir más allá de las convenciones del espacio predefinido, porque puede convertirse en algo nuevo simplemente desplazando el respaldo. Limes New es una historia que contar renovada gracias a los detalles elegantes y técnicos: el corte asimétrico de los cojines del respaldo mejora el apoyo de la zona lumbar, la búsqueda de un nuevo material garantiza el efecto suave de la pluma de oca y asegura un confort sin necesidad de mantenimiento, una discreta revisitación de los volúmenes en armonía con la estética contemporánea y, para terminar, un inédito cilindro que puede usarse como brazo en honor al concepto clásico latino. Patas aéreas de metacrilato o de metal con acabado cromado y doble profundidad. Completamente desenfundable.

p. 096

Moduli sedute / Seating units - 80

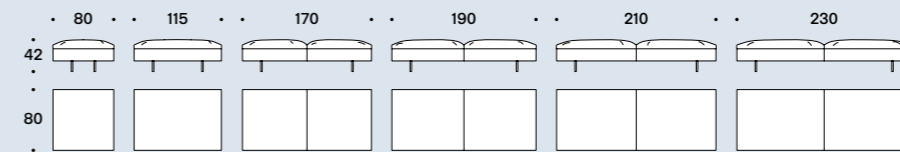

Fianco con schienale - 80 / Side backrest - 80

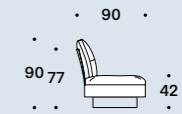

Moduli sedute / Seating units - 88

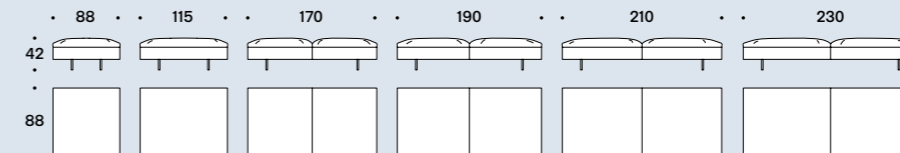

Fianco con schienale - 88 / Side backrest - 88

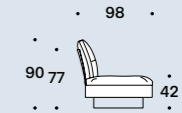

Penisole / Chaise longue - 80-88-115

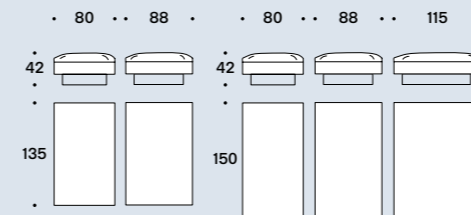

Cuscini schiena / Back cushions



Cuscini Braccioli / Armrest cushions



Finitura piedi / Feet finish

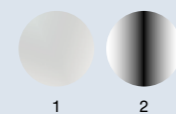

- 1 Metacrilato / Methacrylate / Méthacrylate / Metacrilato
- 2 Black nichel / Black nickel / Nickel noir / Niquel negro

Finitura struttura pannelli schienali / Frame backrest panels finish

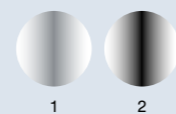

- 1 Cromo / Chrome / Chrome / Cromo
- 2 Black nichel / Black nickel / Nickel noir / Niquel negro

Schienali cromo - tessuto - intreccio imbottito / Chrome - fabric - padded braided backrests

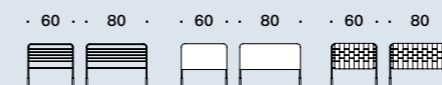

Braccioli cromo - tessuto - intreccio imbottito - cilindro / Chrome - fabric - padded braided - roll armrests

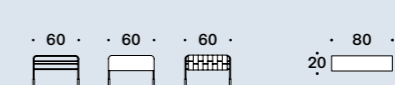

it — Un viaggio attorno al divano dall'estetica pulita e atemporale, questa l'emozione che si prova scoprendo Voyage. Essenziale e contemporanea la sua superficie, eclettica e sorprendente la sua anima. Voyage si assembla e si riassume con semplici gesti adattandosi ad ogni esigenza di living. Saba rinnova la sua vocazione ad interpretare il valore della flessibilità con questo nuovo modello dagli schienali sottili che consentono un comfort ottimale col minimo ingombro e permettono di trasformare una composizione in due divani o un divano in vis a vis o chaise longue. Disponibile in due varianti di piede: metacrilato o in metallo finitura cromata. Completamente sfoderabile.

en — This sofa offers clean lines and an unique flexible design gives a feeling of momentum towards a larger journey. The upholstery options are essential and contemporary, eclectic and give character. Voyage can be assembled and re-assembled with simple configurations adapting to any living scenario. This new model reinforces Saba's ethos for interpreting the value of flexibility. From the slender backrests that allow upmost comfort with minimal volume to the multiple configurations they enable. Voyage can be configured into two sofas or one sofa in vis a vis positioning, or into a chaise lounge formation. It's available in two variations - with methacrylate or chrome finished metal feet. Fully removable covers.

fr — Un voyage autour d'un canapé à l'esthétique épurée et intemporelle : voici l'émotion que l'on ressent en découvrant Voyage. Sa surface est essentielle et contemporaine, tandis que son âme est éclectique et surprenante. Voyage s'assemble et se réassemble avec simplicité, s'adaptant aux besoins du salon. Saba réinterprète la flexibilité avec ce nouveau modèle aux dossiers fins qui offrent un confort optimal et un encombrement minimal, tout en permettant de transformer la composition en deux canapés, en un canapé vis-à-vis ou en chaise longue. Disponible dans deux variantes de pieds en méthacrylate ou en métal finition chromée. Entièrement déhoussable.

es — Un viaje alrededor de un sofá de estética depurada y atemporal, esta es la emoción que se siente al descubrir Voyage. Su superficie es esencial y contemporánea, su alma es ecléctica y sorprendente. Voyage se monta y se vuelve a montar con sencillos gestos adaptándose a cualquier exigencia del espacio. Saba renueva su vocación de interpretar el valor de la flexibilidad con este nuevo modelo de respaldo delgado que asegura un confort excelente a la vez que ocupa el mínimo espacio y que consiente transformar una composición en dos sofás o un sofá de vis a vis o una chaise longue. Disponible en dos variantes con patas de metacrilato o de metal con acabados cromado. Completamente desenfundable.

p. 108

Moduli sedute / Seating units

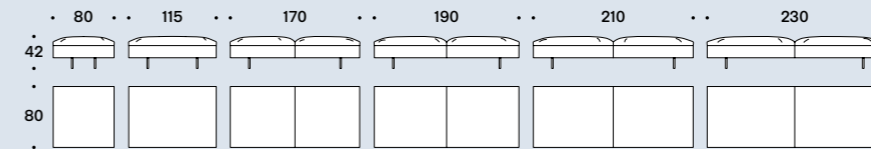

Fianco con schienale / Side backrest

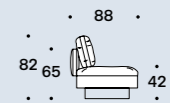

Penisole / Chaise longue - 80-115

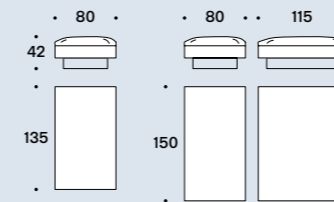

Schienali / Backrests



Braccioli pannello e cilindro / Panel and roll armrests

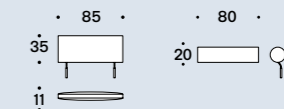

Finitura piedi / Feet finish

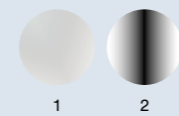

- 1 Metacrilato / Methacrylate / Méthacrylate / Metacrilato
- 2 Black nichel / Black nickel / Nickel noir / Niquel negro

Cuscini schiena / Back cushions

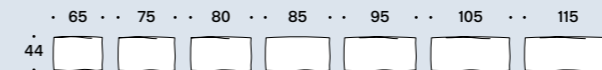

Cuscino schiena angolo / Corner back cushion

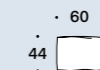

Cuscino bracciolo / Armrest cushion

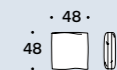

it — Up, attraverso un semplice espediente che ricorda il gioco a incastro tipico dei Lego, consente di scegliere l'altezza dello schienale che meglio corrisponde al proprio desiderio di ergonomia. L'elevazione dello schienale e il conseguente aumento della profondità di seduta si ottengono infatti appoggiando i cuscini posteriori sopra lo schienale basso. La loro particolare forma assicura la massima stabilità. L'utilizzo della piuma d'oca in tutte le cuscinate ne rivela l'anima morbida e accogliente. Disponibile in pelle con finitura "taglio a vivo". Completamente sfoderabile.

en — The Up sofa uses a simple mechanism similar to Lego's snap-on system that allows customers to choose the height of the backrest that best satisfies their comfort requirements. The back cushions can be placed on top of the low backrest to create a deeper seat and an overall higher backrest. The particular shape of the cushions ensures maximum stability. The goose-feather padded cushions and armrests create a particularly soft, snug sofa. Also available with raw-edged leather upholstery. Fully removable covers.

fr — Up, à travers un dispositif élémentaire qui rappelle l'encastrement typique des Lego, permet de choisir la hauteur du dossier qui correspond le mieux à l'ergonomie désirée. Le soulèvement du dossier et l'augmentation de la profondeur d'assise qui en découlent s'obtiennent en posant les coussins arrière sur le dossier bas. Leur forme particulière assure une stabilité parfaite. L'utilisation de la plume d'oie pour tous les coussins en révèle l'âme moelleuse et accueillante. Disponible en cuir avec bords coupés à cru. Entièrement déhoussable.

es — Con un sencillo movimiento que recuerda el juego de encastrado típico del Lego, Up permite elegir la altura del respaldo que se adapta mejor a las exigencias ergonómicas. De hecho, la elevación del respaldo y el consiguiente aumento de la profundidad del asiento se obtienen apoyando los cojines traseros sobre el respaldo bajo. Su forma particular asegura la máxima estabilidad. El uso de la pluma de ganso en toda la serie de cojines revela una textura suave y acogedora. Disponible en piel con acabado "corte en vivo". Completamente desenfundable.



p. 118

Divani / Sofas

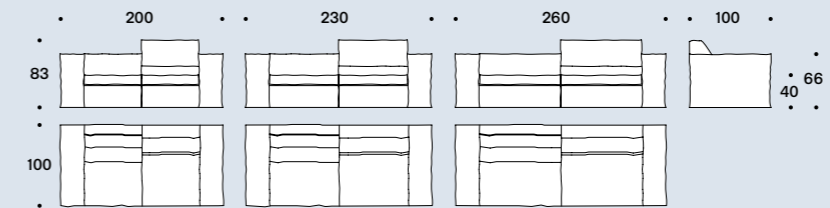

Lateral DX-SX / Right-left side units

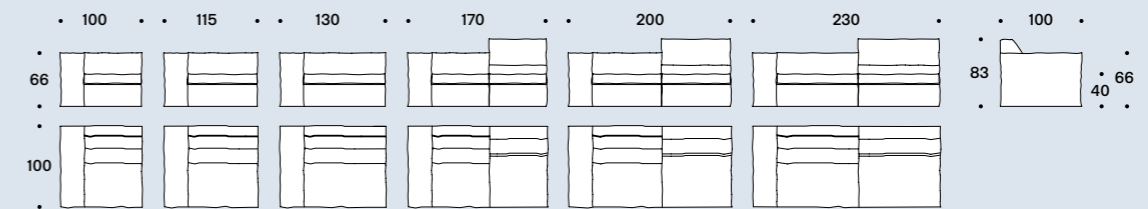

Centrali / Central units

Angolo / Corner unit

Pouf

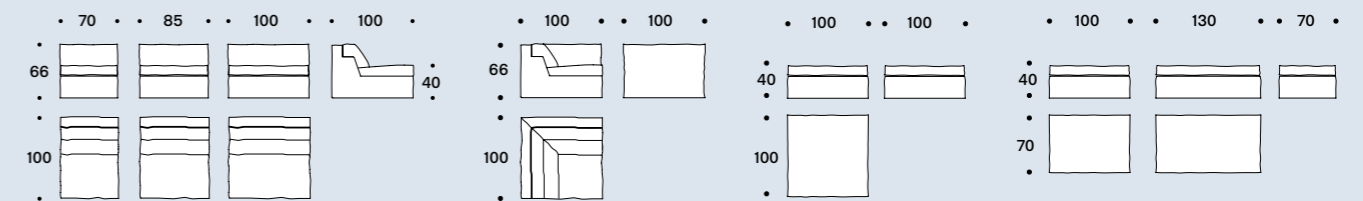

Penisole DX-SX / Right-left chaise longue

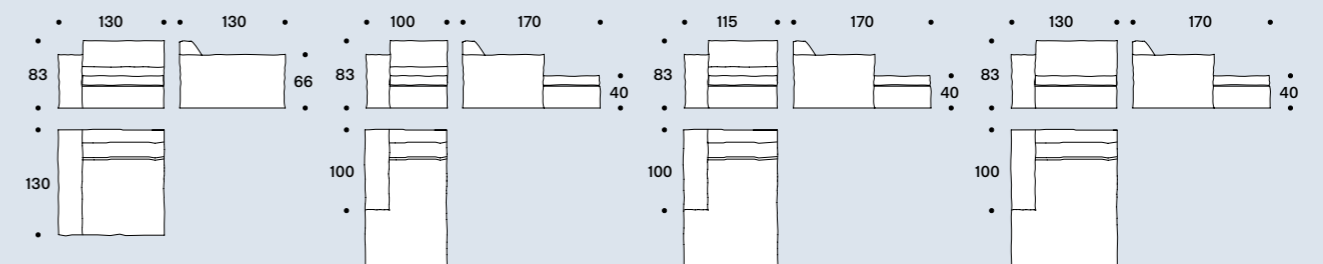

it – Essentiel si presenta con una precisa dichiarazione di intenti. Un progetto privo di eccessi, dall'ergonomia accogliente, che nella mappa spazio-temporale del design congiunge idealmente l'eleganza storica italiana al tratto nordico. L'attenzione per i dettagli, che da sempre caratterizza le collezioni Saba, si ritrova nelle trapuntature dei cuscini schienale e nella profilatura in cordino di canetè. Essenziale nella linea ma duttile nella personalizzazione, anche i cuscini schiena nelle misure da 67 cm e 77 cm possono essere scelti nella versione alta con rullo d'appoggio. Il modello è disponibile nelle misure divano da 154 - 190 - 220 - 250 cm. I moduli si articolano in una vasta gamma di laterali, penisole e terminali per ogni esigenza di composizione. La poltrona Essentiel completa con la sua allure sofisticata questo progetto senza tempo. Completamente sfoderabile.

en – The Essentiel sofa presents itself with a clear purpose. A design without excess and friendly ergonomics, it represents a mix of Italian elegance and northern traits, merging harmonious elements in the space-time map of design. Attention to detail, a feature that has always characterized Saba collections, can be noticed in the quilting of backrest cushions and the grosgrain cord trim. With essential lines that can be customized, the 67cm and 77cm backrest pillows are also available in the higher version with a support roller. This sofa is available in the following sizes: 154 - 190 - 220 - 250 cm. With its sophisticated allure, our Essentiel armchair completes this timeless collection. Fully removable covers.

fr – Essentiel se présente comme une déclaration d'intention sans détours. Une proposition dépourvue d'excès, à l'ergonomie accueillante, qui à travers l'espace spatio-temporel du design conjugue idéalement la tradition d'élégance à l'italienne traditionnelle à la solidité nordique. L'attention au détail, toujours de prime importance dans les collections Saba, prend tout son sens au niveau du capitonnage du dossier et dans la densité de la surpiqure. Essentiel est également une ligne qui sait se faire adaptable. Les dossiers existent en 67 et 77 cm et en version haut de gamme, un dossier rouleau multifonctionnel est proposé. Le modèle est disponible en version canapé dans les tailles suivantes: 154 - 190 - 220 - 250 cm. Les divers modules s'articulent dans une gamme étendue de compléments latéraux, îlots ou d'extrémité et se prêtent à toutes les combinaisons. Le fauteuil Essentiel vient parachever l'allure sophistiquée de cet ensemble parfaitement atemporel. Entièrement déhoussable.

es – Essentiel se presenta con una declaración de intenciones precisa. Un proyecto sin excesos, de ergonomía acogedora, que en el mapa espacial-temporal del diseño une idealmente la histórica elegancia italiana al rasgo nórdico. La atención a los detalles que siempre ha caracterizado las colecciones Saba se observa en los respaldos de los cojines de los respaldos y en el perfilado en cinta de canalé. Esenciales en la línea pero dúctiles en la personalización, los cojines del respaldo en las medidas 67 cm y 77 cm se pueden elegir en la versión alta con rodillo de apoyo. El modelo está disponible en las medidas de sofá de 154 - 190 - 220 - 250 cm. Los módulos se articulan en una amplia gama de laterales, penínsulas y terminales para cualquier exigencia de composición. El sillón Essentiel completa con su aspecto sofisticado este proyecto imprecdero. Completamente desenfundable.

p. 126

Divani / Sofas

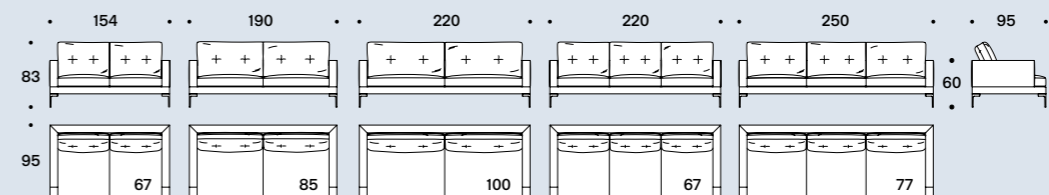

Laterali DX-SX / Right-left side units

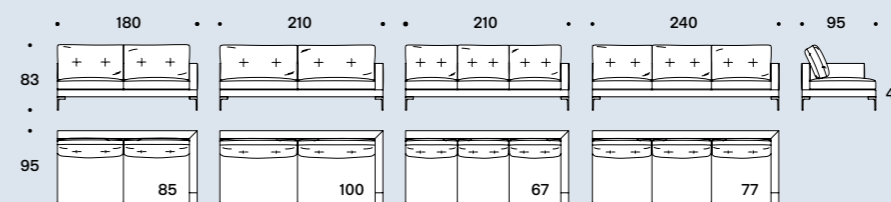

Angolare / Corner unit

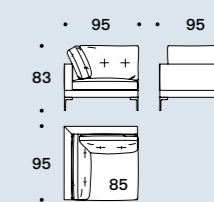

Penisole DX-SX / Right-left chaise longue

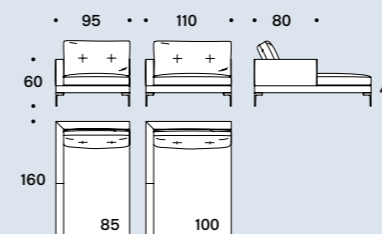

Terminale DX-SX / Right-left end unit

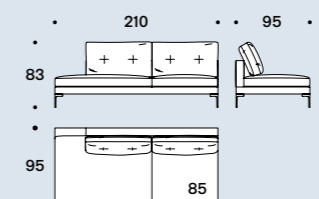

Terminale angolare DX-SX / Right-left corner end unit

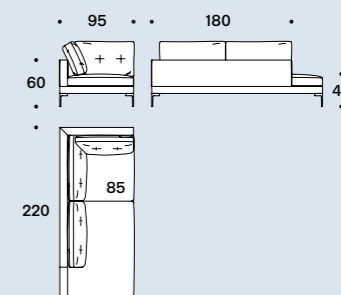

Finitura piedi / Feet finish



- 1 Grigio / Grey / Gris / Gris
- 2 Verniciato corten / Painted corten / Peint corten / Pintado corten

Cuscini schiena alti / High back cushions

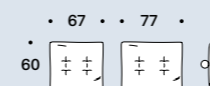

Cuscini arredo / Throw cushions

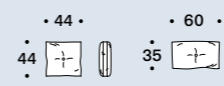

Pouf

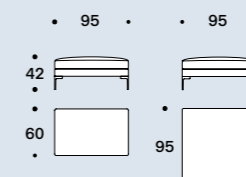

Poltrona / Armchair

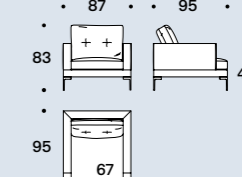

Poltroncina / Small armchair

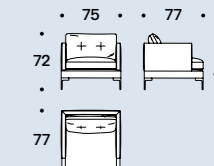

it — Rendez-vous è il nuovo sistema di sedute pensato non solo per la casa ma anche per gli spazi collettivi. Obiettivo del progetto consentire un'estrema flessibilità compositiva con pochi elementi di base. Il punto di partenza è una struttura metallica verniciata nera sulla quale si fissano i moduli orientandoli a propria scelta. Il risultato è un appuntamento con il piacere estetico: angoli curvi da ritmare a linee pure per disegnare ambienti di elevata personalità. I tavoli di appoggio, in due misure e due diverse finiture, sottolineano la funzione d'uso nei luoghi d'incontro. Le imbottiture rispondono già alle specifiche richieste del mondo contract e a tal fine è stata scelta parte della collezione tessile. Completamente sfoderabile.

en — Rendez-vous is the new seating system envisaged not only for the home environment, but also for public spaces. The aim of the project is to allow utmost flexibility in configurations with very few elements. The foundation is a metallic black painted structure on which various elements are fixed and can be moved according to the user's preference. The result allows for seated encounters with aesthetic pleasure. Curved angles contrast with pure lines creating interiors with strong personality. The design of the side tables, in two measurements and finishes, underlines the functional needs in places of encounters. The upholstery textile range includes the durable materials specified for use in commercial applications. Fully removable covers.

fr — Rendez-vous est le nouveau système d'assises pensé non seulement pour la maison, mais également pour les espaces collectifs. L'objectif de ce projet est de permettre une flexibilité de composition absolue avec quelques éléments de base. Le point de départ est une structure métallique laquée noire sur laquelle sont fixés les modules qui peuvent être orientés selon les goûts. Le résultat est un rendez-vous avec le plaisir esthétique : des angles incurvés rythment des lignes épurées pour dessiner des espaces à la forte personnalité. Les tables d'appoint, dans deux dimensions et deux finitions différentes, soulignent la fonction d'utilisation dans les lieux de rencontre. Les rembourrages répondent aux besoins spécifiques de l'univers contract et ont été choisis dans la collection textile. Entièrement déhoussable.

es — Rendez-vous es el nuevo sistema de asiento pensado no solo para casas sino también para espacios colectivos. El objetivo del proyecto es permitir una extrema flexibilidad compositiva con pocos elementos de base. El punto de partida es una estructura metálica pintada de negro sobre la que se fijan los módulos que pueden orientarse según se desee. El resultado es una cita con el placer estético: esquinas redondeadas que combinan con líneas puras para diseñar ambientes con mucha personalidad. Las mesitas de apoyo, de dos medidas y con dos tipos de acabado distintos, resaltan su función en los lugares de reunión. Los acolchados responden a las necesidades del mundo contract y por ello, se han elegido como parte de la colección textil. Completamente desfundable.

p. 138

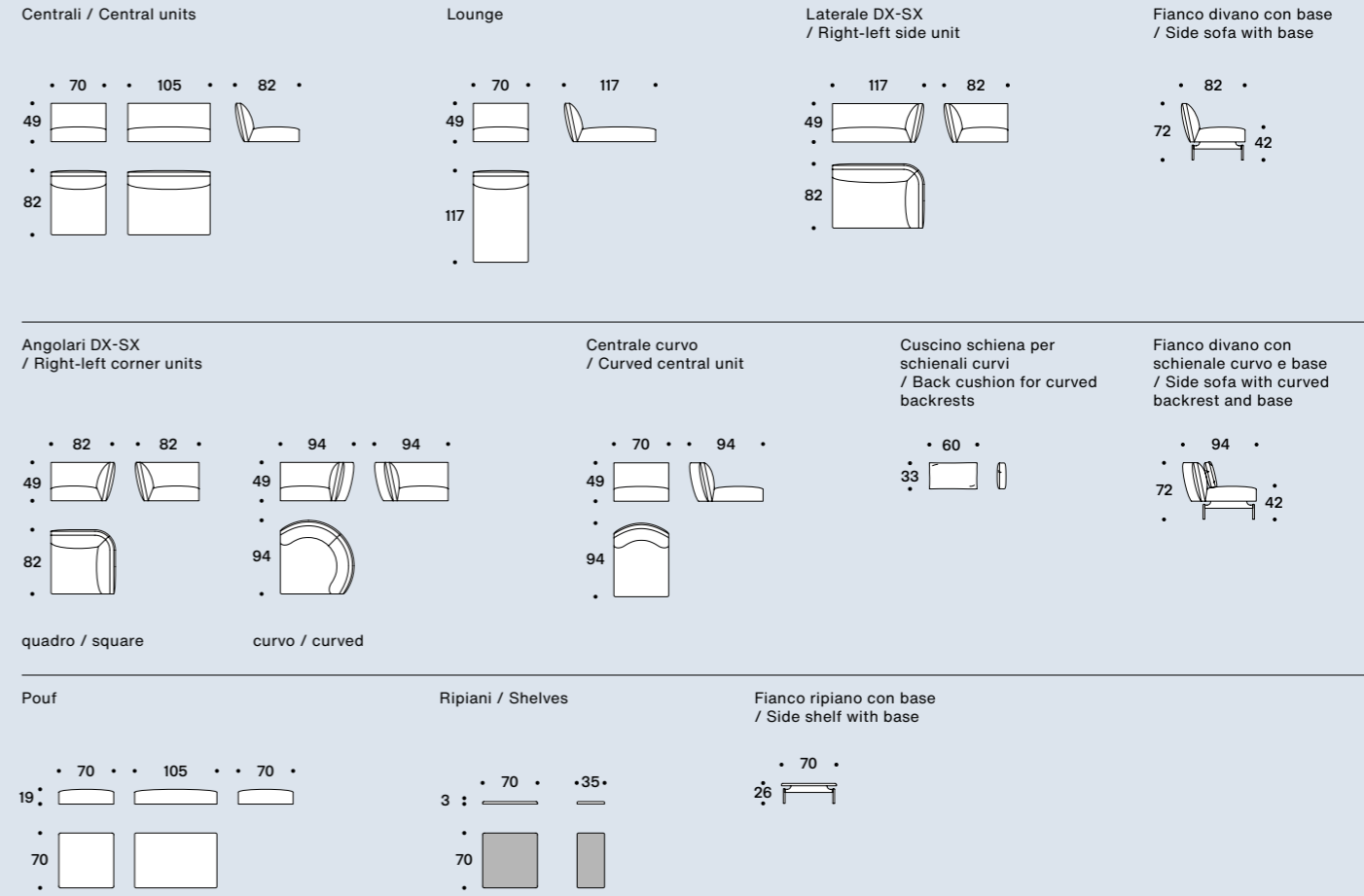

Finitura piedi / Feet finish



- 1 Nero / Black / Noir / Negro
- 2 Black nichel / Black nickel / Nickel noir / Niquel negro



Esempi composizioni / Examples of compositions

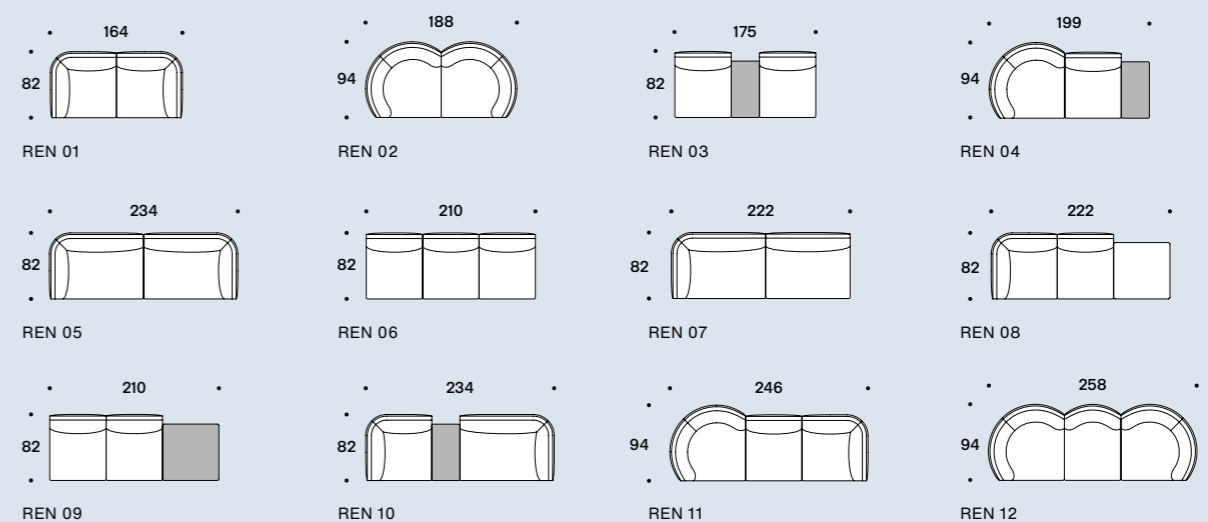

it — Les Femmes è un divano componibile dallo schienale alto e dalla seduta accogliente, caratterizzato da forme morbide e avvolgenti. L'originale progetto consente con solo tre moduli la massima libertà compositiva: la possibilità di variare le posizioni dello schienale e del bracciolo lo rende infatti un sistema giocoso ed estremamente versatile. Con schienale e bracciolo rialzati, Les Femmes è un divano intimo e rassicurante, con bracciolo reclinabile è sfizioso e accattivante, con schienale reclinabile è girovago e divertente. Lo schienale e il bracciolo possono essere reclinati verso l'esterno attraverso un particolare congegno a "snodo" che ne permette un movimento fluido e rapido tramite un semplice gesto della mano. Completamente sfoderabile.

en — Les Femmes is a modular sofa with a high backrest and a comfortable seat, characterized by its soft, enveloping shape. Its original design allows for maximum freedom of customization with its three elements: the back and arm rests can be positioned in a variety of ways, making Les Femmes a playful and extremely versatile system. With the back and arm rests raised, it is a snug and familiar sofa. The back and arm rests can also be reclined outwards through a special "swivel" device, a quick and fluid movement achieved with a simple motion of the hand. Fully removable covers.

fr — Les Femmes est un canapé modulable, comprenant un dossier haut et une assise accueillante, caractérisé par des formes douces et enveloppantes. Avec seulement trois modules, ce projet original permet une grande liberté de composition : la possibilité de modifier les positions du dossier et de l'accoudoir en fait un système dynamique et extrêmement flexible. Avec le dossier et l'accoudoir relevés, Les Femmes est un canapé intime et rassurant ; avec l'accoudoir replié, il devient séduisant et prêt à donner corps à toutes les fantaisies ; avec le dossier replié, il prend un air baroudeur et amusant. Le dossier et l'accoudoir peuvent être repliés vers l'extérieur à travers un mécanisme articulé particulier qui permet un mouvement fluide et rapide, un simple geste de la main. Entièrement déhoussable.

es — Les Femmes es un sofá componible de respaldo alto y asiento acogedor, caracterizado por formas delicadas y envolventes. El proyecto original con sólo tres módulos ofrece una gran libertad de composición: la posibilidad de modificar las posiciones del respaldo y del brazo que lo convierte en un sistema sumamente versátil. Con el respaldo y el brazo levantados, Les Femmes es un sofá íntimo y confortante, su brazo reclinable es extravagante y encantador, su respaldo reclinable es móvil y divertido. El respaldo y el brazo pueden reclinarse hacia afuera mediante un sistema articulado especial que permite un movimiento fluido y rápido con sólo mover una mano. Completamente desenfundable.

p. 154

Poltrone / Armchairs

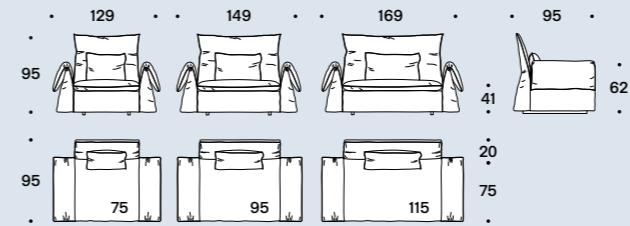

Centrali / Central units

Angolare / Corner

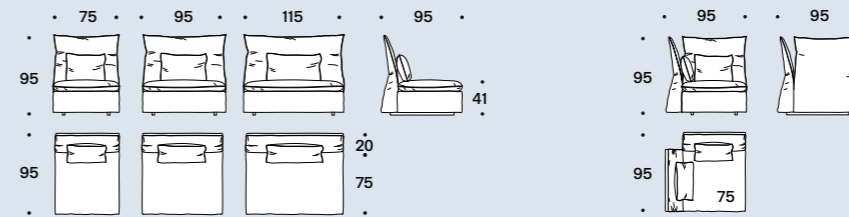

Laterale DX-SX / Right-left side units

Fianco con schienale rialzato e reclinato / Side with raised and reclined backrest

Penisola SX-DX / Right-left chaise longue

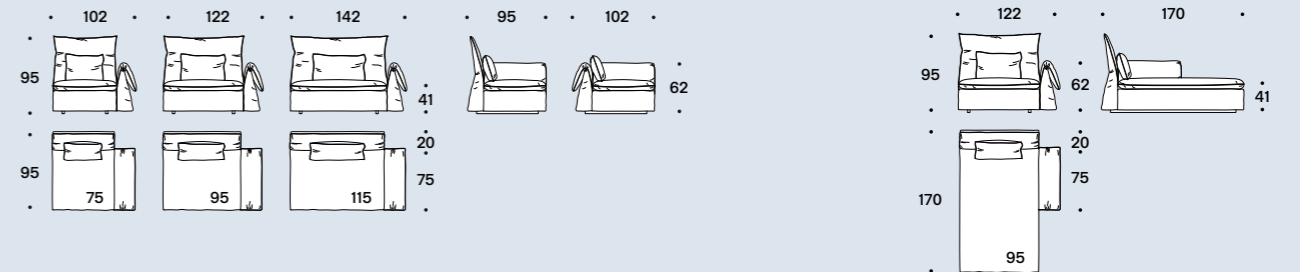

Cuscini / Cushions

Pouf

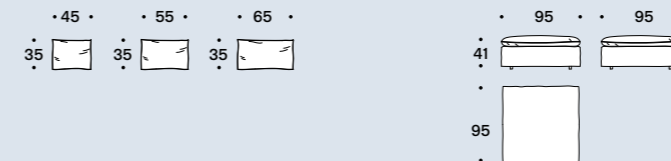

it – Livingston gioca sull'effetto sorpresa tramite un uso inaspettato del poggiatesta che, con un semplice gesto di rotazione, diventa un comodo poggiatesta. È dotato di uno schienale "intelligente" accoppiato a un cuscino più piccolo tramite semplici cerniere. La seduta, soffice e informale, dialoga con una struttura aerea in acciaio che dà slancio alla generosità delle cuscinate. La particolarità dello schienale regolabile e la caratteristica del cuscino unico di seduta conferiscono al divano Livingston un profilo unico e originale, declinabile in infinite composizioni. Completamente sfoderabile.

en – Livingston creates a surprising effect through an unexpected use of the headrest which, by a simple rotation, becomes a comfortable backrest. It has a "smart" backrest to which a smaller cushion is attached with a zip. The soft, informal seating rests on a light steel base that creates a dynamic contrast with the generous cushions. The original, adjustable backrest and its characteristic full-length seat cushions give Livingston a unique silhouette ideally suited to creating an endless variety of arrangements. Fully removable covers.

fr – Livingston joue sur l'effet de surprise avec un emploi inattendu de l'appuie-tête qui, par un simple geste de rotation, se transforme en appui lombaire. Il est muni d'un dossier « intelligent » accouplé à un coussin plus petit par une simple fermeture à glissière. L'assise, moelleuse et informelle, dialogue avec une structure aérienne en acier qui compense la générosité des coussins. La particularité du dossier réglable et le coussin d'assise d'un seul tenant donnent au canapé Livingston un profil unique et original, déclinable en d'infinies compositions. Entièrement déhoussable.

es – Livingston juega con el efecto sorpresa mediante el uso inesperado del reposacabeza que, con un gesto de rotación muy sencillo, se transforma en un cómodo apoyo para la espalda. Dispone de un respaldo "inteligente", asociado con un cojín más pequeño mediante simples cremalleras. El asiento, suave e informal, se completa con una estructura aérea de acero que hace resaltar a la generosidad de los cojines. La peculiaridad del respaldo ajustable y la característica del cojín único del asiento otorgan al sofá Livingston un perfil único y singular, que se declina en composiciones infinitas. Completamente desenfundable.

Finitura piedi / Feet finish

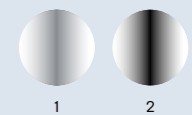

1 Cromo / Chrome / Chrome / Cromo
2 Black nichel / Black nickel
/ Nickel noir / Níquel negro



p. 160

Divani / Sofas

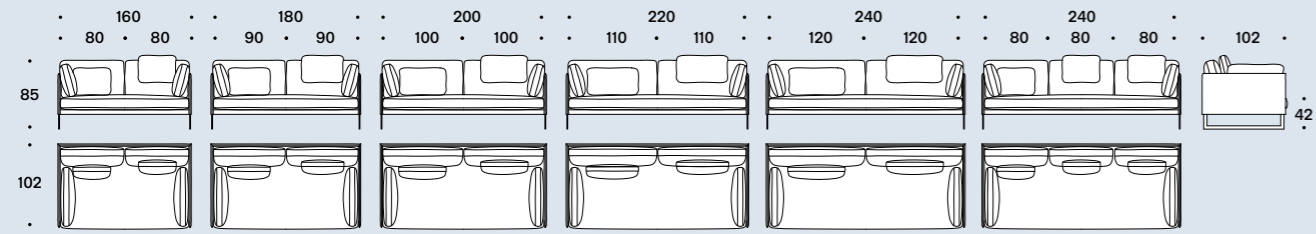

Laterali DX-SX / Right-left side units

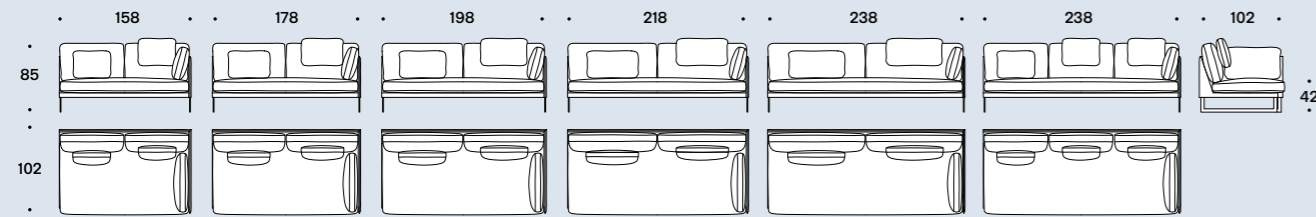

Divani angolari DX-SX / Right-left corner sofas

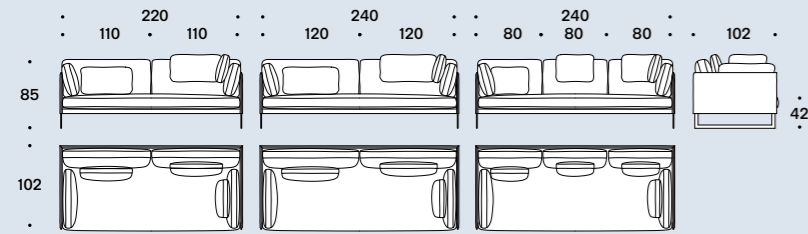

Laterali angolari DX-SX / Right-left corner side units

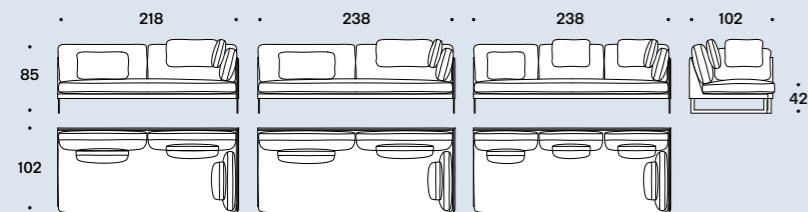

p. 160

Terminali DX-SX / Right-left end units

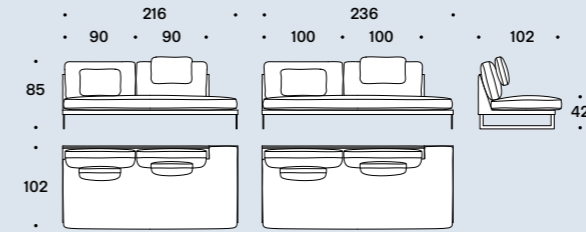

Terminali angolari DX-SX / Right-left corner end units

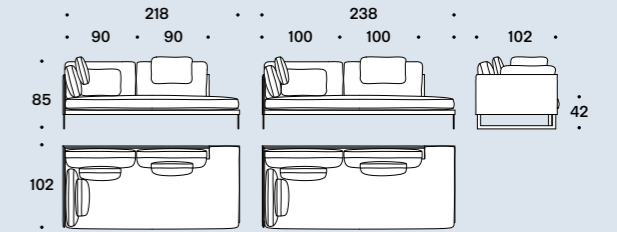

Meridienne DX-SX / Right-left Meridienne

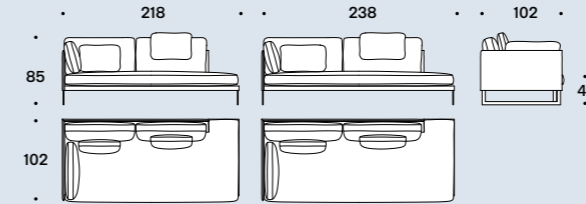

Laterale DX-SX / Right-left side unit - 110

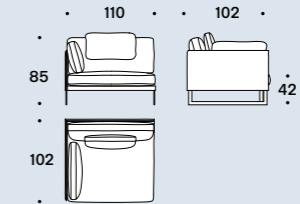

Penisola DX-SX / Right-left chaise longue - 160

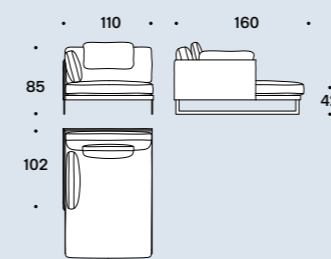

Penisola DX-SX / Right-left chaise longue - 180

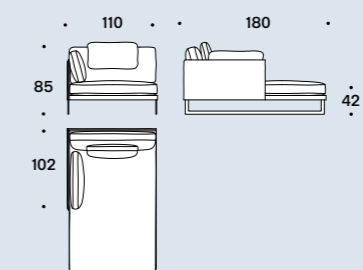

Poltrona / Armchair

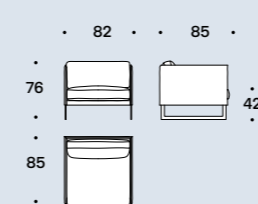

Pouf

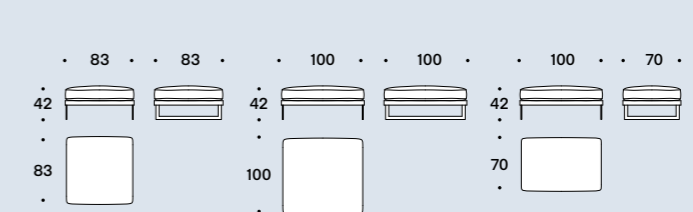

it — A volte un nome racconta un mondo, a volte un nome è un mondo. Geo è un progetto a tutto tondo. Voluminoso ma leggero, grazie al particolare disegno della struttura esterna, Geo è come un nido sospeso nel vuoto sostenuto da piccoli rami. I volumi sono disegnati con cura e guardandolo con attenzione ci si accorge che gli spessori dei braccioli sono leggermente diversi dallo spessore dello schienale perchè hanno una funzione diversa e perchè ci si è voluti allontanare dalla banale idea di avere una fascia uniforme che gira intorno ad una seduta. Il piano di seduta è meno bombato dei braccioli perchè deve essere accogliente e non respingente mentre i braccioli più gonfi ti avvolgono in un tenero abbraccio. Tutto è studiato per dar vita ad una creatura dove il tanto (la seduta) e il poco (le gambe) trovano il giusto equilibrio. La struttura metallica su cui poggia impreziosisce il progetto garantendo inoltre una maggiore pulizia. Completamente sfoderabile.

en — Sometimes a name can say a lot, sometimes it says everything. Geo is an all rounded project. The proportions have been designed with upmost attention to detail and with careful observation it will be noticed that the arm width is slightly different to that of the back, the ergonomic needs are different, and it has been a design choice to steer clear from a more typical uniform width that goes right around the entire armchair. The seat itself has less padding compared to the arms which are designed to hug the body. Every detail has been carefully studied to give life to a special object where the main volume of the seat and the very light volume of the legs find a unique harmony together. The metallic adds a luxurious feel. Further the material shell is completely removable for dry cleaning and the metal structure in the various finishings is designed for easy cleaning. Fully removable covers.

fr — Parfois, un nom évoque un monde, et d'autres fois un nom est un monde. Geo est un projet tout en rondeur. Volumineux mais léger, grâce à la forme particulière de sa structure extérieure, Geo est comme un nid suspendu dans le vide par de petites branches. Les volumes sont dessinés avec soin et, si on le regarde avec attention, on s'aperçoit que l'épaisseur des accoudoirs diffère légèrement de celle du dossier parce qu'ils jouent un rôle différent et parce que l'on a voulu s'éloigner de l'idée banale d'une bande uniforme qui tourne autour d'une assise. L'assise est moins bombée que les accoudoirs car elle doit être accueillante et non repoussante, tandis que les accoudoirs plus gonflés vous enlacent tendrement. Tout est étudié pour donner vie à une créature où épaisseur (pour l'assise) et finesse (pour les pieds) sont en équilibre parfait. Sa structure métallique enrichit le projet et lui garantit un aspect plus épuré. Entièrement déhoussable.

es — A veces un nombre habla de un mundo, a veces un nombre es un mundo. Geo es un proyecto totalmente redondo. Voluminoso pero ligero, gracias al particular diseño de su estructura externa, Geo es como un nido suspendido en el vacío sostenido por pequeñas ramas. Los volúmenes han sido diseñados con minuciosidad y al observarlo con atención uno se da cuenta de que los espesores de los brazos son ligeramente diversos del espesor del respaldo ya que tienen una función diversa y porque se ha querido alejarse de la banal idea de tener una franja uniforme que gira en torno a un asiento. El plano de asiento es menos abombado que los brazos porque debe ser acogedor y no repelente, mientras que los brazos más abultados te envuelven en un tierno abrazo. Todo ello estudiado para dar vida a una criatura en la que lo mucho (el asiento) y lo poco (las patas) encuentran su justo equilibrio. La estructura metálica de apoyo enriquece el proyecto garantizando asimismo una mayor pulcritud. Totalmente desenfundable.



p. 168

Divano / Sofa

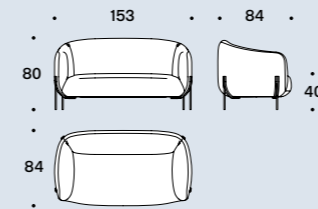

Poltrona / Armchair

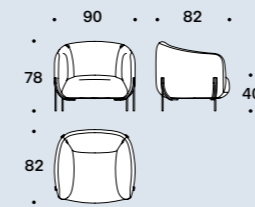

Poltroncina / Small armchair

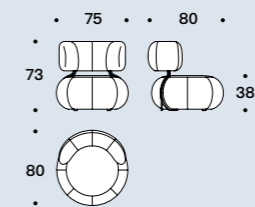

Pouf

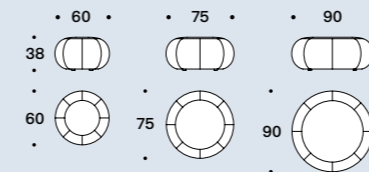

Pouf con telaio / Pouf with frame

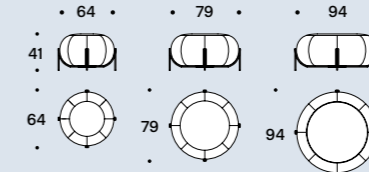

Finitura struttura / Frame finish

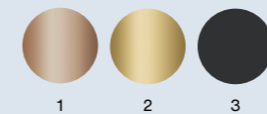

- 1 Rame lucido / Glossy copper / Cuivre brillant / Cobre brillante
- 2 Ottone satinato / Satin brass / Laiton satiné / Latón satinado
- 3 Grigio / Grey / Gris / Gris

it — *Philo* è il prefisso di origine greca che indica amore, propensione e simpatia verso persone o cose. Un filo metallico disegna la sintesi dell'accoglienza, corre, gira, sale e scende, abbraccia e sostiene delicatamente le superfici imbottite. *Philo* modifica con agilità le sue dimensioni per dare vita a un sistema di sedute capaci di convivere con diversi ambienti: la casa, gli spazi pubblici e in generale i luoghi dell'incontro, dell'accoglienza e delle relazioni. Filantropico per natura si veste con eleganza e semplicità, nelle sue forme asciutte e oneste. Comunica la sua simpatia giocando con le linee e i colori, il filo metallico si trasforma in filo di cucitura e ancora trama e ordito, mescolate e unite in unica armonia. Completamente sfoderabile.

en — *Philo* is a prefix of Greek origins that indicates love, propensity and empathy towards people and things. A metallic thread draws together a welcoming silhouette; it runs, turns, comes up and goes down, hugging and delicately supporting the upholstered surfaces. The agile dimensions give life to a seating system capable of existing in different spaces: homes, offices, hospitality and places of meeting in general where relationships are nourished. Philanthropic by nature this elegant and simple sofa has a lean yet grounded honest form. The design's character is communicated with an interplay of lines and colours. The metallic thread transforms into sewing thread and continues on to weft and warp creating a singular harmony. Fully removable covers.

fr — *Philo* est le préfixe grec qui indique l'amour, l'attrance et la sympathie envers les personnes ou les choses. Un fil métallique dessine la synthèse de l'accueil, court, tourne, monte et descend, étroit et soutient avec délicatesse les surfaces rembourrées. *Philo* modifie avec habileté ses dimensions pour donner vie à un système d'assises en mesure de cohabiter dans plusieurs environnements : la maison, les espaces publics et, de manière plus générale, les lieux de rencontre, d'accueil et de relation. Philanthropique par nature, il se pare d'élégance et de simplicité grâce à ses formes épurées et honnêtes. Il communique sa sympathie en jouant avec les lignes et les couleurs, tandis que le fil métallique se transforme en fil de trame et en fil de chaîne, mélangés et unis dans une harmonie unique. Entièrement déhoussable.

es — *Philo* es el prefijo de origen griego que indica amor, propensión y simpatía hacia personas o cosas. Un hilo metálico dibuja la síntesis de acogida, corre, gira, sube y baja, abraza y sostiene de forma delicada las superficies acolchadas. *Philo* modifica rápidamente sus dimensiones para dar vida a un sistema de asiento capaz de convivir con ambientes diferentes: la casa, los espacios públicos y en general, los lugares de reunión, de acogida y de las relaciones. Filantrópico por naturaleza se viste con elegancia y sencillez, con sus formas puras y honestas. Comunica su simpatía jugando con las líneas y los colores, el hilo metálico se transforma en hilo de coser y trama, mezclados y unidos creando juegos llenos de armonía. Completamente desenfundable.

p. 172

Divani / Sofas

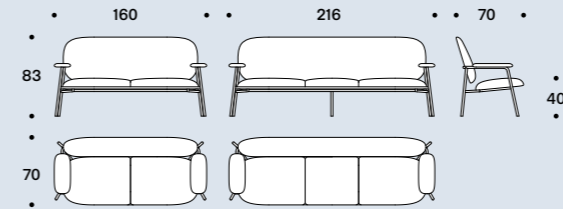

Poltrona / Armchair

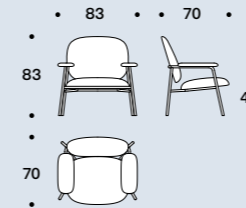

Finitura struttura opaca / Matt frame finish



1

1 Nero / Black / Noir / Negro



it — La collezione Kepi accoglie un nuovo elemento: il divano a due posti da 160 cm. Il rigore del disegno e il tratto vagamente nordico si addolciscono sulle sue linee arrotondate, determinando una presenza di carattere oltre che di grande comfort. A differenza del progetto originario, il divano Kepi abbraccia la completa simmetria con un doppio poggiatesta e un unico cuscino seduta. Il suo design essenziale e l'eleganza disimpegnata lo rendono perfetto sia per l'ambiente domestico che per il contract. La snella struttura portante è in tubolare di acciaio verniciato. Completamente sfoderabile.

en — The Kepi sofa's sober design and vaguely Nordic look are softened by rounded lines that add character and improve comfort. This is the Kepi sofa, featuring complete symmetry with two back cushions and one seat cushion. Its clean design and nonchalant elegance make it perfect for the home and a contract environment. The functional supporting structure is made of tubular stainless steel. Fully removable covers.

fr — La collection Kepi accueille un nouvel élément : le canapé deux places de 160 cm. Le design rigoureux et l'esprit vaguement nordique s'adoucissent en des lignes arrondies, créant une présence de caractère et extrêmement confortable. Contrairement au projet initial, le canapé Kepi arbore une totale symétrie avec un double cale-reins et un seul coussin d'assise. Son design épuré et son élégance discrète le rendent parfait pour l'espace domestique tout comme pour le contract. Sa structure portante élancée en tube d'acier laqué. Entièrement déhoussable.

es — La colección Kepi acoge un nuevo elemento: el sofá de dos plazas de 160 cm. El rigor del diseño y el trazo ligeramente nórdico se suavizan con las líneas redondeadas, determinando una presencia no sólo de carácter sino también de gran confort. A diferencia del proyecto original, el sofá Kepi abraza la geometría completa con un cojín lumbar doble y un solo cojín de asiento. Por su diseño esencial y elegancia desinteresada, resulta ideal tanto para el ambiente doméstico como para el contract. La esbelta estructura portante es de tubos de acero pintado. Totalmente desenfundable.

p. 178

Divano / Sofa

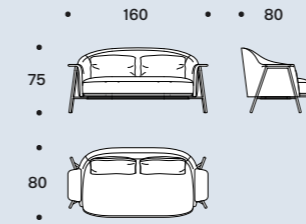

Poltrona / Armchair

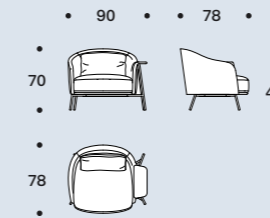

Pouf

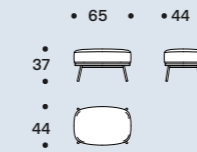

Finitura struttura in metallo / Metal frame finish



- 1 Rosso Bordeaux / Red Bordeaux / Rouge Bordeaux / Rojo Burdeos
- 2 Blu cobalto / Cobalt blue / Bleu cobalt / Azul cobalto
- 3 Grigio / Grey / Gris / Gris



New York Dining design Sergio Bicego

it — La famiglia New York accoglie una nuova proposta di seduta particolarmente idonea per gli ambienti contract. New York Dining, la panca a due posti con o senza braccioli mantiene l'agile struttura di tutta la collezione oltre alla confortevole imbottitura che si distingue per la delicata trapuntatura tono su tono. Disponibile con finitura cromata o verniciata. Completamente sfoderabile.

en — The New York family adds yet another seating solution to the dining area collection. New York Dining is a two-seater bench with integrated armrests that maintains the collection's agile structure as well as the comfortable upholstery distinguished by small tonal quilted parts. Available in chrome or painted finish. Fully removable covers.

fr — La famille New York accueille un nouveau type d'assise particulièrement bien adapté aux environnements professionnels. New York Dining, la banquette à deux places avec ou sans accoudoirs conserve la structure agile qui caractérise toute la collection, en plus d'un rembourrage confortable qui se distingue par un délicat matelassage ton sur ton. Disponible en finition chromée ou laquée. Entièrement déhoussable.

es — La familia New York acoge una nueva propuesta de asiento especialmente adecuada para ambientes contract. New York Dining, el asiento de dos plazas con o sin posabrazos, mantiene la estructura ágil de toda la colección además de un confortable acolchado que se distingue por el delicado pespunte tono sobre tono. Disponible con acabado cromado o pintado. Totalmente desenfundable.



p. 182, 288

Panchetta con e senza braccioli / Bench with and without armrests

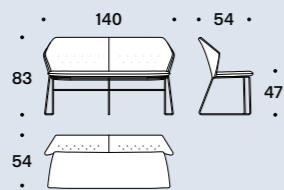
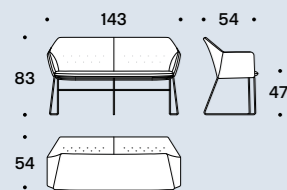

Finitura struttura / Frame finish



- 1 Bianco / White / Blanc / Blanco
- 2 Nero / Black / Noir / Negro
- 3 Cromo / Chrome / Chrome / Cromo
- 4 Black nichel / Black nickel / Nickel noir / Niquel negro

Quinta strada design Sergio Bicego

it — Progettato nel 1996, il sistema di seduta Quinta Strada, è stato un progetto "pioniere" dello stile moderno. Rigoroso ma flessibile nella componibilità, viene ora rieditato attraverso un restyling attento ai dettagli del nuovo linguaggio contemporaneo. La finitura black nichel del piede, l'assottigliamento delle staffe di congiunzione, la leggerezza della base e del supporto schienale sono gli eleganti particolari adeguati al moderno living. I diversi elementi della collezione Quinta Strada permettono numerose configurazioni, consentendo composizioni particolarmente interessanti anche nelle situazioni ad angolo. Completamente sfoderabile.

en — Launched in 1996, the Quinta Strada seating range represented a pioneering design in modern style. Streamlined yet modularly flexible, the range has since then been restyled and re-produced with a sensitivity that is mindful of the new contemporary language. The black nichel finish of the feet, the thinner joining clamps as well as the lightness of the base and back support are elegant touches aligned with modern lifestyle. The various elements in the Quinta Strada collection allow for numerous configurations and particularly interesting compositions even in corner situations. Fully removable covers.

fr — Conçu en 1996, le système de sièges Quinta Strada a été un projet « pionnier » du style moderne. Rigoureux mais flexible dans ses possibilités de composition, il est maintenant réédité à travers un restyling attentif aux détails du nouveau langage contemporain. La finition nickel noir du pied, la finesse des éléments de raccordement, la légèreté de la base et du support du dossier, sont les détails élégants adaptés à un living moderne. Les différents éléments de la collection Quinta Strada permettent de nombreuses configurations, en donnant vie à des compositions particulièrement intéressantes également dans les solutions d'angle. Entièrement déhoussable.

es — Diseñado en 1996, el sistema de asientos Quinta Strada representa un proyecto "pionero" del estilo moderno. Riguroso aunque flexible en su composición, se repropone con un diseño actualizado, atento a los detalles del nuevo lenguaje contemporáneo. El acabado niquel negro de la pata, el afinamiento de las abrazaderas de unión, la ligereza de la base y del soporte del respaldo, son detalles elegantes perfectos para el vivir moderno. Los distintos elementos de la colección Quinta Strada ofrecen la posibilidad de crear numerosas configuraciones, permitiendo composiciones particularmente interesantes, también para los modelos de esquina. Completamente desenfundable.



Finitura piedi & staffa / Feet & bracket finish



- 1 Black nichel / Black nickel / Nickel noir / Niquel negro

p. 186

Divani / Sofas

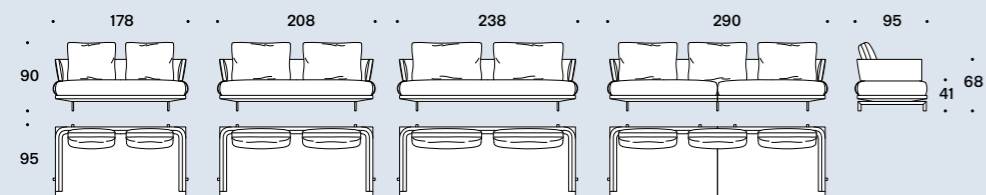

Laterali DX-SX / Right-left side units

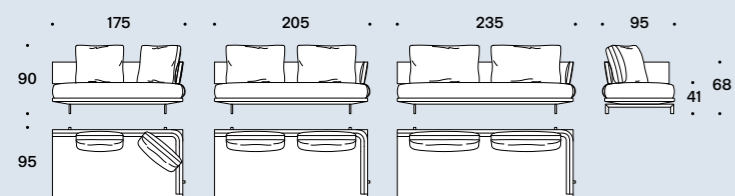

Terminali angolari DX-SX / Right-left corner units

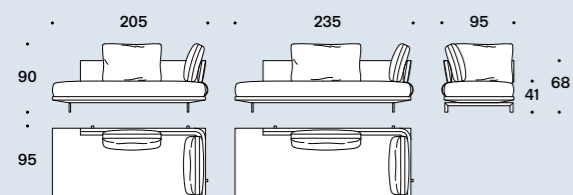

Penisola DX-SX / Right-left chaise longue

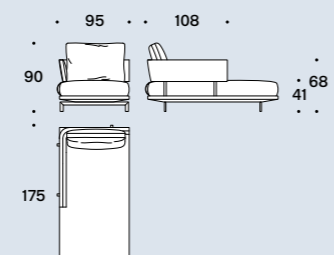

Pouf

Cuscini arredo / Throw cushions

Cuscino poggiatesta / Lower back cushion

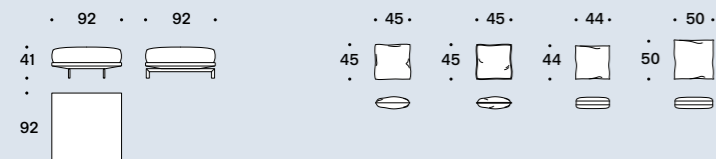

p. 186

Laterali DX-SX angolo 22,5° / Right-left 22,5° corner side units

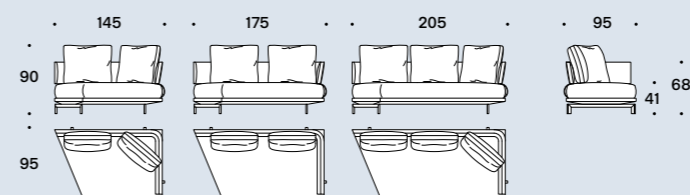

Terminali DX-SX angolo 22,5° / Right-left 22,5° corner end units

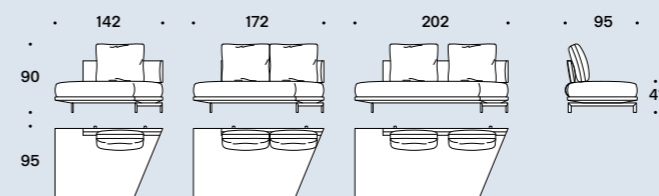

Esempi composizioni angolo 22,5° / Examples of 22,5° corner compositions

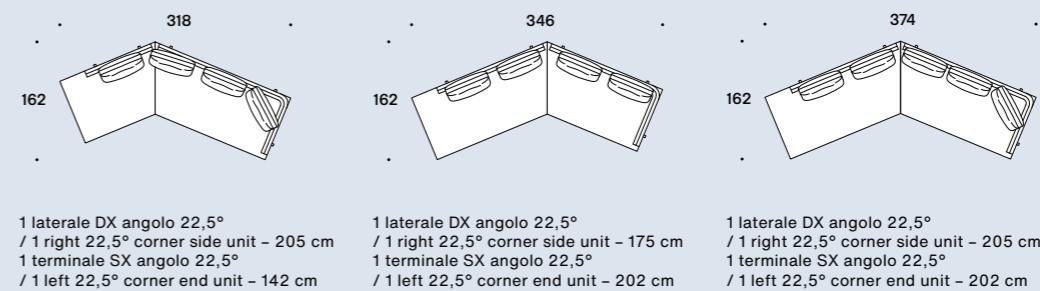
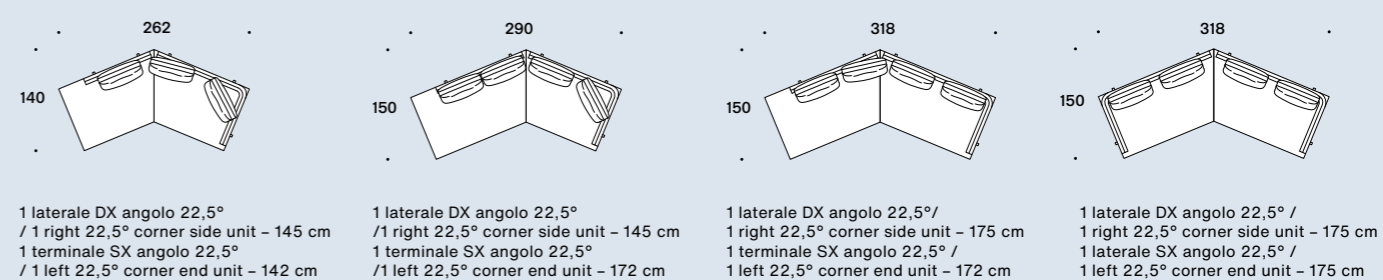

it — La collezione Karma incarna meglio di qualunque altro la versatilità dei prodotti di Saba Italia: un divano che trova posto sia negli ambienti moderni che nelle abitazioni di impronta più classica. Il successo di Karma cavalca così gli anni e le tendenze, grazie a un'attenzione nei dettagli quasi maniacale. I suoi 110 cm di profondità diventano agili per merito di accorgimenti stilistici che ne esaltano l'importanza senza appesantirlo. Proporzioni raffinate, design senza tempo e grande adattabilità a qualsiasi tipo di rivestimento fanno di Karma un divano irrinunciabile. Completamente sfoderabile.

en — The Karma collection is the ultimate expression of the versatility of Saba Italia products: a sofa that fits seamlessly into both modern settings and more classical homes. Karma has been riding the wave of success through passing years and fleeting fashions, thanks to its almost obsessive attention to detail. Design details ensure comfortable seating despite its depth of 110 cm, and add to its substance without weighing it down. Elegant proportions, timeless design and absolute suitability for any type of covering make Karma feel like the sofa of your destiny. Fully removable covers.

fr — La collection Karma incarne mieux que toute autre la flexibilité des créations Saba Italia : un canapé qui trouve sa place aussi bien dans les intérieurs modernes que dans les contextes de style plus classique. Le succès de Karma traverse ainsi les années et les modes, grâce à une attention pour les détails qui frise l'obsession. Ses 110 cm de profondeur sont relativisés par des solutions de style qui en exaltent l'importance sans l'alourdir. Des proportions raffinées, un design sans âge et une grande adaptabilité à n'importe quel type de revêtement font de Karma une valeur sûre. Entièrement déhoussable.

es — La colección Karma encarna mucho mejor que cualquier otra la versatilidad de los productos de Saba Italia: un sofá que encuentra su colocación tanto en los espacios modernos como en las habitaciones de estilo más clásico. El éxito de Karma supera los años y las tendencias, gracias a una atención meticulosa a los detalles. Sus 110 cm de profundidad se hacen ágiles por mérito de soluciones estilísticas que exaltan su importancia sin añadir pesadez. Las proporciones refinadas, el diseño atemporal y la gran adaptabilidad a cualquier tipo de tapizado hacen de Karma un sofá irrenunciable. Completamente desenfundable.

p. 194

Divani / Sofas

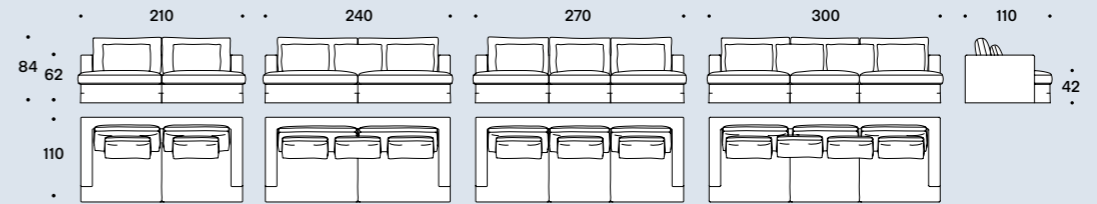

Laterali DX-SX / Right-left side units

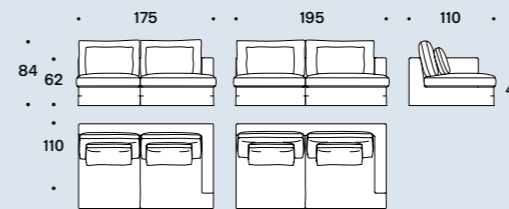

Terminale angolare DX-SX / Right-left corner end unit

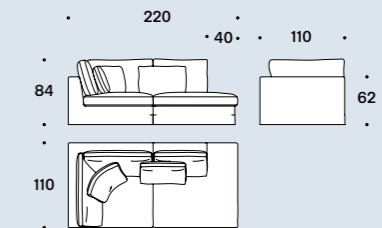

Penisola DX-SX / Right-left chaise longue

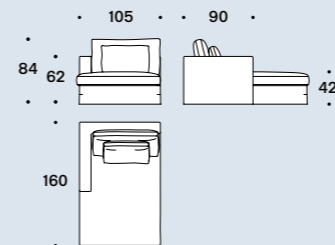

Angolare / Corner unit

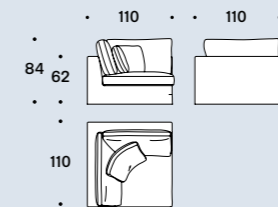

Pouf

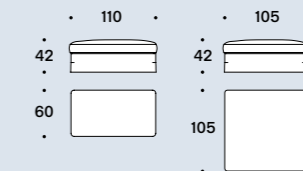

Poltrona / Armchair

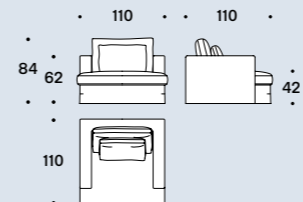

Cuscino arredo / Throw cushion

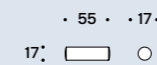

No Logo Light

design Sergio Bicego

it — La doppia anima, maschile e femminile al tempo stesso, di No Logo Light consente a questa poltrona di convivere sia nelle case più familiari ed accoglienti che negli spazi pubblici rigorosi. In particolare risalta il contrasto tra l'austerità della struttura in acciaio e la sorprendente comodità della seduta. Prodotta a partire dal 2005, No Logo Light si pone con carattere al centro del vivere quotidiano, senza creare disturbo ma facendosi sempre notare. Completamente sfoderabile.

en — No Logo Light exhibits a double soul, both masculine and feminine, to fit into the coziest family homes and into the most rigorous of public spaces. Its most striking features are the austerity of the steel frame and the unexpectedly comfortable seat cushion. In production since 2005, No Logo Light places itself squarely at the center of everyday life always drawing attention to itself, yet with the utmost discretion. Fully removable covers.

fr] — La double âme, à la fois masculine et féminine, de No Logo Light permet à cette collection, faite de canapés à deux et trois places et d'un confortable fauteuil, de s'intégrer dans les espaces privés, imprégnés de chaleur domestique, tout comme dans les espaces publics les plus exigeants. Elle met l'accent en particulier sur le contraste entre l'austérité de la structure en acier et le confort surprenant d'assise. Produite depuis 2005, la collection No Logo Light s'impose avec caractère au coeur de notre quotidien, se faisant toujours remarquer mais sans intrusion aucune. Entièrement déhoussable.

es — La doble alma, simultáneamente masculina y femenina de No Logo Light permite que esta colección, compuesta por sofás de dos y tres plazas y por un cómodo sillón, pueda convivir en las casas de familia más acogedoras y en los espacios públicos rigurosos. Resalta particularmente el contraste entre la austeridad de la estructura de acero y la sorprendente comodidad del asiento. Se fabrica desde 2005. No Logo Light impone su carácter y se pone al centro del vivir cotidiano, sin molestar pero haciéndose notar siempre. Completamente desenfundable.



p. 202

Poltrona / Armchair

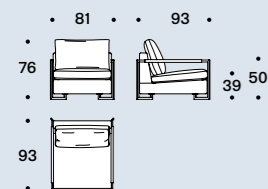

Finitura struttura / Frame finish



1 Black nichel / Black nickel
/ Nickel noir / Níquel negro

New York Armchair

design Sergio Bicego

Saba

it — New York è una collezione che porta con fierezza il nome della Grande Mela. Due anime, uptown e downtown, racchiuse in un unico oggetto di design il cui rivestimento, interamente intercambiabile, ne svela l'innata versatilità. L'insolita e poliedrica ergonomia della poltroncina New York invita a un uso personale del rivestimento e al bicolore, permettendo diverse soluzioni cromatiche attraverso un'unica scelta. La struttura è in tondino di ferro disponibile in molteplici finiture sia di cromatura che di verniciatura. Completamente sfoderabile.

en — New York is a collection which proudly bears the name of the Big Apple. Two souls, uptown and downtown, enclosed in a single design piece whose fully changeable covers reveal its innate versatility. The New York Armchair, with its essential metal frame and endless possibilities of the double textile cushion, allows for a high degree of personalization. The frame in iron rod comes in many colours and coating finishes. Fully removable covers.

fr — New York est une collection qui porte fièrement le nom de la Grande Pomme. Deux âmes, uptown et downtown, réunies dans un unique objet de design dont le revêtement, entièrement interchangeable, en dévoile la flexibilité innée. L'ergonomie insolite aux multiples facettes du fauteuil New York invite à une utilisation personnelle du revêtement et au bicolore, en permettant différentes solutions chromatiques à partir d'un choix unique. La structure est en fil d'acier disponible en de nombreuses finitions, aussi bien chromées que laquées. Entièrement déhoussable.

es — New York es una colección que lleva con orgullo el nombre de la Gran Manzana. Dos almas, uptown y downtown, integradas en un objeto de diseño único, cuyo tapizado, completamente intercambiabile, desvela su innata versatilidad. La ergonomía insólita y poliédrica del sillón New York invita a un uso personal del tapizado y al bicolor, favoreciendo distintas soluciones cromáticas con una elección única. La estructura de barra redonda de hierro está disponible en múltiples acabados cromados y pintados. Completamente desenfundable.



p. 208

Poltrona / Armchair

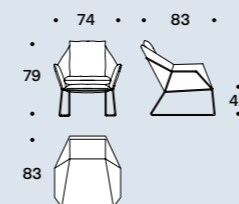

Finitura struttura / Frame finish



1 Bianco / White / Blanc / Blanco



2 Nero / Black / Noir / Negro



3 Rosso / Red / Rouge / Rojo

4 Arancio / Orange / Orange / Naranja

5 Azzurro / Blue / Bleu / Azul

6 Giallo / Yellow / Jaune / Amarillo



7 Cromo / Chrome / Chrome / Cromo



8 Black nichel / Black nickel / Nickel noir / Níquel negro



9 Rame lucido / Glossy copper / Cuivre brillant / Cobre brillante

10 Ottone satinato / Satin brass / Laiton satiné / Latón satinado

11 Bronze copper matt

12 Bronze gold matt

New York
Bergère

design Sergio Bicego

it — La medesima struttura della poltrona New York accoglie la confortevole imbottitura della bergère. La classica funzione della poltrona da lettura o relax è garantita dall'altezza dello schienale, dal comodo poggiatesta e dall'elegante pouf. Un filo continuo con la tradizione interpretato in veste contemporanea con sofisticata leggerezza. Completamente sfoderabile.

en — The same frame as the New York armchair boasts the comfortable upholstery of the bergère. The classic function of the armchair for reading or relaxing is ensured by the height of the back, the comfortable headrest and the elegant pouf. An unbroken link with tradition interpreted in a contemporary style with a sophisticated lightness. Fully removable covers.

fr — La même structure que le fauteuil New York accueille le confortable rembourrage de la bergère. La fonction classique du fauteuil de lecture ou de repos est garantie par la hauteur du dossier, par le confortable appuie-tête et par l'élégant pouf. Un fil continu avec la tradition, interprété sous un jour contemporain avec une légèreté sophistiquée. Entièrement déhoussable.

es — El cómodo relleno acolchado del sillón orejero se replica en la misma estructura del sillón New York. La función clásica del sillón de lectura o descanso está garantizada por la altura del respaldo, el cómodo reposacabezas y el elegante taburete. Un hilo continuo con la tradición interpretado en estilo contemporáneo con sofisticada ligereza. Completamente desenfundable.



p. 213

Bergère

Pouf

Finitura struttura / Frame finish

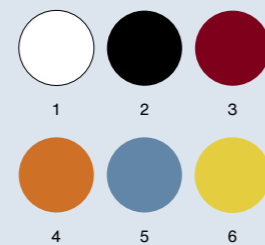
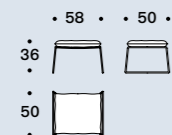
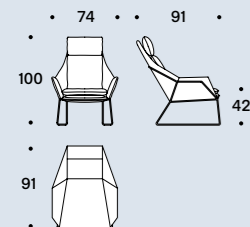

- 1 Bianco / White / Blanc / Blanco
- 2 Nero / Black / Noir / Negro
- 3 Rosso / Red / Rouge / Rojo
- 4 Arancio / Orange / Orange / Naranja
- 5 Azzurro / Blue / Bleu / Azul
- 6 Giallo / Yellow / Jaune / Amarillo

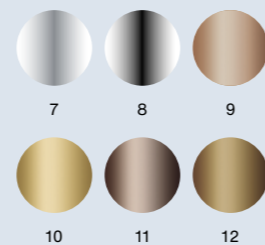

- 7 Cromo / Chrome / Chrome / Cromo
- 8 Black nichel / Black nickel / Nickel noir / Níquel negro
- 9 Rame lucido / Glossy copper / Cuivre brillant / Cobre brillante
- 10 Ottone satinato / Satin brass / Laiton satiné / Latón satinado
- 11 Bronze copper matt
- 12 Bronze gold matt

480

Geo

design Paolo Grasselli

Saba

it — A volte un nome racconta un mondo, a volte un nome è un mondo. Geo è una poltrona a tutto tondo, protagonista dello spazio domestico. Generosa senza essere invadente, accogliente senza essere soffocante, morbida senza essere informe. Voluminosa ma leggera, grazie al particolare disegno della struttura esterna, Geo è come un nido sospeso nel vuoto sostenuto da piccoli rami. I volumi sono disegnati con cura. Tutto è studiato per dar vita ad una creatura dove il tanto (la seduta) e il poco (le gambe) trovano il giusto equilibrio. La struttura metallica su cui poggia impreziosisce il progetto garantendo inoltre una maggiore pulizia. Completamente sfoderabile.

en — Sometimes a name can say a lot, sometimes it says everything. Geo is an all rounded armchair, the protagonist in a home. It's generous without invading space, welcoming without being suffocating and soft without being informal. Thanks to its unique design Geo is voluminous yet light, like a nest suspended in air held up by small branches. The proportions have been designed with upmost attention. Every detail has been carefully studied to give life to a special object where the main volume of the seat and the very light volume of the legs find a unique harmony together. The metallic adds a luxurious feel. Further the material shell is completely removable for dry cleaning and the metal structure in the various finishings is designed for easy cleaning. Fully removable covers.

fr — Parfois, un nom évoque un monde, et d'autres fois un nom est un monde. Geo est un fauteuil tout en rond, qui joue un rôle à part entière dans l'espace domestique. Généreux sans être envahissant, accueillant sans être étouffant, doux sans être informe. Volumineux mais léger, grâce à la forme particulière de sa structure extérieure, Geo est comme un nid suspendu dans le vide par de petites branches. Les volumes sont dessinés avec soin. Tout est étudié pour donner vie à une créature où épaisseur (pour l'assise) et finesse (pour les pieds) sont en équilibre parfait. Sa structure métallique enrichit le projet et lui garantit un aspect plus épuré. Entièrement déhoussable.

es — A veces un nombre habla de un mundo, a veces un nombre es un mundo. Geo es un sillón totalmente redondo, protagonista del espacio doméstico. Generoso sin ser entrometido, acogedor sin ser sofocante, suave sin ser informe. Voluminoso pero ligero, gracias al particular diseño de su estructura externa, Geo es como un nido suspendido en el vacío sostenido por pequeñas ramas. Los volúmenes han sido diseñados con minuciosidad. Todo ello estudiado para dar vida a una criatura en la que lo mucho (el asiento) y lo poco (las patas) encuentran su justo equilibrio. La estructura metálica de apoyo enriquece el proyecto garantizando asimismo una mayor pulcritud. Totalmente desenfundable.



p. 214

Poltrona / Armchair

Finitura struttura / Frame finish

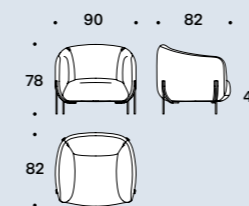

- 1 Rame lucido / Glossy copper / Cuivre brillant / Cobre brillante
- 2 Ottone satinato / Satin brass / Laiton satiné / Latón satinado
- 3 Grigio / Grey / Gris / Gris

481

Armchairs & Poufs

it — La collezione Geo si arricchisce di un elemento: una poltroncina a tutto tondo creata utilizzando come seduta l'omonimo pouf. La struttura in tondino metallico sorregge lo schienale curvato in legno imbottito, le sue forme risultano generose senza essere invadenti. I pouf Geo di diametro 75 cm sono predisposti ad accogliere la struttura dello schienale che può essere agganciata facilmente alla base del pouf anche in un secondo momento. Completamente sfoderabile.

en — The Geo collection is enriched with a fun element: a completely rounded armchair created utilizing the namesake pouf as its seat. The metal rod structure supports the curved padded wooden back. The proportions are generous without being over-bearing. The 75 cm Geo poufs are designed to accommodate the structure of the backrest and can be easily attached to the base of the pouf even at a later time. Fully removable covers.

fr — La collection Geo s'enrichit d'un élément : un fauteuil entièrement rond créé en utilisant comme assise le pouf homonyme. Sa structure en tube métallique soutient le dossier incurvé en bois rembourré, tandis que ses formes sont généreuses sans être envahissantes. Les poufs Geo, d'un diamètre de 70 cm, sont prévus pour accueillir la structure du dossier qui s'accroche rapidement et facilement à la base du pouf. Entièrement déhoussable.

es — La colección Geo cuenta con un elemento: un sillón completamente redondo que ha sido creado utilizando como asiento el puf homónimo. La estructura realizada con varillas de metal soporta el respaldo curvado de madera acolchada, sus formas resultan generosas sin ser demasiado excesivas. Los puf Geo de 70 cm de diámetro han sido diseñados para acoger la estructura del respaldo que puede fijarse fácilmente a la base del puf en un segundo momento. Completamente desenfundable.



p. 218

Poltroncina / Small armchair

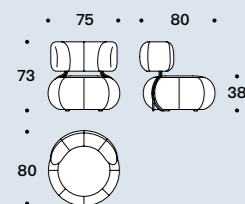

Finitura struttura / Frame finish



1 Rame lucido / Glossy copper
/ Cuivre brillant / Cobre brillante
2 Ottone satinato / Satin brass
/ Laiton satiné / Latón satinado
3 Grigio / Grey / Gris / Gris

it — Chance è una poltroncina girevole dalle dimensioni contenute, adatta a prestarsi come elemento funzionale-decorativo in ogni contesto abitativo e contract. Una forma senza tempo, la cui anima si rivela di volta in volta attraverso l'abito di cui si riveste. Completamente sfoderabile.

en — Chance is a compact swiveling tub chair, equally functional and decorative in both domestic and contract settings. The perfectly round timeless shape can reveal many different souls depending on the chosen textile. Fully removable covers.

fr — Chance est un fauteuil pivotant aux dimensions contenues, qui peut devenir un élément fonctionnel et décoratif dans n'importe quel contexte, privé ou public. Une forme atemporelle, dont l'âme se révèle à chaque fois différente, suivant l'habit qu'on veut lui donner. Entièrement déhoussable.

es — Chance es una butaca giratoria de dimensiones no excesivas, apta para convertirse en un elemento funcional y decorativo en cualquier espacio residencial y colectivo. Una forma atemporal, cuya alma se desvela a través de los tapizados con los que se recubre. Completamente desenfundable.



p. 222

Poltrona / Armchair

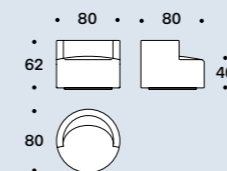

Chillout

it — Avvolgente come una musica d'ambiente, Chillout esplora la nuova tendenza del design di rendere contemporaneo un pensiero classico. Il progetto, che porta la firma del designer Giuseppe Viganò, si ispira a un'idea di living informale e reinterpreta il design anni '50 con le sue linee sinuose. Piccoli accorgimenti sartoriali e l'originale bracciolo, donano a Chillout un'immagine armoniosa e la rendono una seduta estremamente confortevole. Snella eppure accogliente, con la sua silhouette avvolgente dal sofisticato sapore retrò, ha il fascino unico dell'handmade. Un prodotto passepartout, perfetto in ogni ambiente, da quello domestico casa agli spazi contract. Completamente sfoderabile.

design Giuseppe Viganò

en — As soothing as background music, Chillout explores the new design trend that recreates old classics with a modern twist. Designed by Giuseppe Viganò, this piece of furniture draws its inspiration from a laid-back living area, whilst its slinky shape harks back to the '50s. Sharp tailoring details and an original armrest give Chillout a balanced appeal and make for a highly comfortable seat. Slender yet inviting with a sleek retro feel, it oozes the unique allure of handmade objects. From home interiors to contract projects, this is an all-purpose purchase which will fit perfectly into any surroundings. Fully removable covers.

fr — Tel une musique d'ambiance qui vous envelopperait, Chillout explore la nouvelle tendance du design : revisiter le contemporain avec un esprit classique. Le projet, qui porte la signature du designer Giuseppe Viganò, s'inspire d'un concept informel du salon et réinterprète le design des années 1950 avec ses lignes sinueuses. De petites innovations au niveau de la couture, associées à un accoudoir original, confèrent à Chillout un look harmonieux et en font un siège d'un confort incomparable. Simple mais confortable, avec la silhouette enveloppante aux accents rétro sophistiqués, il possède le charme du cousu main. Produit passepartout, il est parfait dans toutes les ambiances, à la maison ou dans les espaces professionnels. Entièrement déhoussable.

es — Envolverte como una música de ambiente, Chillout explora la nueva tendencia del diseño de hacer contemporáneo un pensamiento clásico. El proyecto lleva la firma del diseñador Giuseppe Viganò, se inspira en una idea de sala de estar informal y reinterpreta el diseño años 50 con sus líneas sinuosas. Los pequeños detalles de alta costura y el original brazo dan a Chillout una imagen armoniosa y lo convierten en un sillón sumamente confortable. Esbelto pero acogedor, con su silueta envolvente y con un sofisticado sabor retrò, tiene el encanto único de lo que está hecho a mano. Un producto comodín ideal para cualquier entorno, desde los ambientes domésticos hasta los espacios contract. Completamente desenfundable.



p. 226

Poltrona / Armchair

Pouf

Finitura piedi / Feet finish

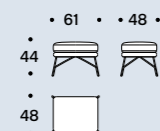
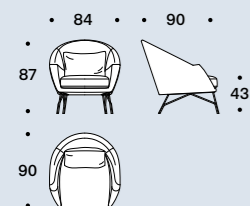

1 Black nichel / Black nickel / Nickel noir / Niquel negro

484

Amélie

it — Deliziosa e aggraziata, la poltroncina Amélie rimanda all'haute couture francese. La particolare trapuntatura che sottolinea le curve interne è realizzata a mano seguendo uno schema non casuale. Contenuta ma di forte appeal, si presta ad arredare qualsiasi spazio in cui ci sia l'esigenza di una seduta. Le cuciture trapuntate possono a scelta essere commissionate a contrasto, in un gioco di personalizzazione infinito. Colore su colore per Amélie: le sfumature di tendenza ne esaltano le forme sinuose. Disponibile anche con base girevole, completamente sfoderabile.

design Sergio Bicego

en — Delightfully pretty, the Amélie tub chair conjures up visions of French haute couture. The inner curves have been deliberately emphasised by a clever hand-quilted patterning effect. Compact yet with a strong appeal, Amélie would be an attractive addition to any space where seating is required. Customers can choose to order the quilted stitching in a contrasting colour, offering endless possibilities to suit personal choice. Tone-on-tone for Amélie: the latest hues give prominence to its graceful lines. Also available with a swivel base, fully removable covers.

fr — Gracieux et raffiné, le fauteuil Amélie renvoie à la haute couture française. Son matelassage qui en souligne les courbes internes est réalisé à la main suivant un schéma précis. De dimensions contenues mais doté d'un grand charisme, il s'adapte à n'importe quel espace. Les coutures du matelassage peuvent être commandées au choix dans une couleur contrastante permettant ainsi une personnalisation infinie. Ton sur ton pour Amélie : les nuances tendance en exaltent les formes sinueuses. Disponible également avec pied pivotant, entièrement déhoussable.

es — Deliciosa y agraciada, la butaca Amélie evoca la alta costura francesa. El pespunteado particular que remarca las curvas internas se realiza a mano siguiendo un esquema definido. De pequeñas dimensiones pero muy atractivo, es ideal para decorar cualquier espacio que presente la exigencia de un asiento. Las costuras pespunteadas pueden realizarse en contraste, con un infinito juego de personalizaciones. Color sobre color para Amélie: las tonalidades de tendencia exaltan las formas sinuosas. Disponible también con base giratoria, totalmente desenfundable.



p. 230

Poltroncina / Small armchair

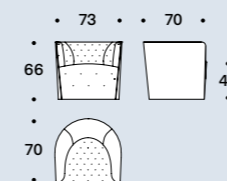

485

Armchairs & Poufs

Bustier

design Giuseppe Viganò

it — Forme eleganti e sinuose per Bustier, una poltrona che trae ispirazione dai busti avvolgenti delle dame ottocentesche. Bustier si compone di una scocca rigida che abbraccia soffici cuscini in piuma prestando le sue forme a innumerevoli cambi d'abito e interpretazioni. La collezione tessuti di Saba Italia, unica nel suo genere, interpreta in modo eclettico Bustier per arredare, decorando, sia zone living che contract. Disponibile anche con base girevole, completamente sfoderabile.

en — Bustier's elegant, curvy shape was inspired by the body-hugging corsets worn by ladies in the 19th century. Its rigid shell embraces soft feather cushions, and its shape means you can adapt it to many different covers and uses. The unique Saba Italia fabric collection offers an eclectic selection of Bustier covers for residential or contract furnishing. Also available with a swivel base, fully removable covers.

fr — Formes élégantes et sinueuses pour Bustier, un canapé qui s'inspire des corsets enveloppants des femmes du XIXe siècle. Bustier se compose d'une coque rigide qui enserre des coussins moelleux en plume, en prêtant ses formes à d'innombrables habillages et interprétations différentes. La collection des tissus Saba Italia, unique en son genre, interprète Bustier avec éclectisme pour meubler, tout en décorant, aussi bien les living domestiques que les espaces collectifs. Disponible également avec pied pivotant, entièrement déhoussable.

es — Formas elegantes y sinuosas para Bustier, un sofá que se inspira en los corsés envolventes de las damas del Ochocientos. Bustier se compone de una estructura rígida que abraza mullidos cojines de pluma, que prestan sus formas a innumerables cambios de tapicería e interpretaciones. La colección de tejidos de Saba Italia es única en su género e interpreta el espíritu de Bustier en modo ecléctico, para amueblar decorando tanto las zonas de estar como los espacios comunitarios. Disponible también con base giratoria, totalmente desenfundable.



p. 234

Poltrona / Armchair

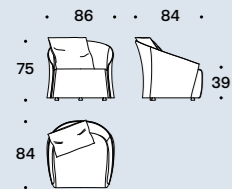

486

Essentiel

design Sergio Bicego

it — La poltrona Essentiel si presenta con una precisa dichiarazione di intenti: un progetto privo di eccessi, dall'ergonomia accogliente, che nella mappa spazio-temporale del design congiunge idealmente l'eleganza storica italiana al tratto nordico. Essenziale nella linea, ma duttile nella personalizzazione, può essere arricchita da un cuscino arredo rettangolare o quadrato con dettaglio bottone. La sua allure sofisticata viene esaltata dalla profilatura in cordino di canetè. Completamente sfoderabile.

en — The Essentiel armchair was born with a clear mission: uncluttered, soft and welcoming, in design terms it magnificently fuses clean Scandinavian lines with traditional Italian flair. It has a clean-cut silhouette, yet it is easy to personalise by adding a rectangular or square throw cushion with a button detail. Its sophisticated allure is accentuated with a grosgrain cord trim. Fully removable covers.

fr — Le fauteuil Essentiel se présente comme une déclaration d'intention sans détours : une proposition dépourvue d'excès, à l'ergonomie accueillante, qui à travers l'espace spatio-temporel du design conjugue idéalement la tradition d'élégance à l'italienne traditionnelle à la solidité nordique. Essentiel est également une ligne qui sait se faire adaptable, il peut être sublimé par un coussin d'ornement rectangulaire ou carré avec détail bouton. Son allure sophistiquée est exaltée en particulier par la densité de la surpiqure. Entièrement déhoussable.

es — El sillón Essentiel se presenta con una declaración de intenciones precisa: un proyecto sin excesos, de ergonomía acogedora, que en el mapa espacial-temporal del diseño une idealmente la histórica elegancia italiana al rasgo nórdico. Esencial en la línea pero dúctil en la personalización, se puede enriquecer con un cojín decorativo rectangular o cuadrado con detalle de botón. Su aspecto sofisticado es exaltado por el perfilado en cinta de canalé. Completamente desenfundable.



p. 238

Poltrona / Armchair

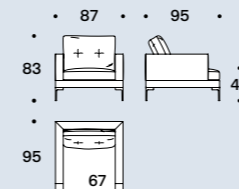

Finitura piedi / Feet finish



1 Grigio / Grey / Gris / Gris
2 Verniciato corten / Painted corten / Peint corten / Pintado corten

487

Armchairs & Poufs

it — Baby Essentiel, la poltroncina della famiglia Essentiel, offre una seduta dalle dimensioni contenute che segue le stesse linee dell'omonimo divano, forme prive di eccessi e dall'ergonomia confortevole. Una poltrona che richiama l'eleganza storica italiana, unendo elementi sofisticati ad una linea essenziale. L'attenzione per i particolari, si ritrova nei cuscini trapuntati e nel particolare piedino leggero verniciato che supporta la poltrona. Disponibile anche con la profilatura in cordino di canetè. Completamente sfoderabile.

en — The Baby Essentiel armchair offers a contained seating solution that follows the same design as the sofa and exhibits a form without excess and with comfortable ergonomics. An armchair that recalls a certain Italian historical elegance, merging sophisticated elements with a simple outline. The attention to details that distinguishes Saba can be found in the quilted cushions and in the thin painted legs that support the armchair. Also available with a grosgrain cord trim. Fully removable covers.

fr — Baby Essentiel, le petit fauteuil de la famille Essentiel, offre une assise aux dimensions réduites, qui suit les mêmes lignes que le canapé du même nom, avec des formes sans excès et à l'ergonomie confortable. Un fauteuil qui rappelle l'élégance historique italienne, alliant des éléments sophistiqués et une ligne essentielle. L'attention accordée aux détails se retrouve dans les coussins matelassés et dans le piètement particulier, peint et léger, qui supporte le fauteuil. Disponible également avec un passepoil en cordon de canneté. Entièrement déhoussable.

es — Baby Essentiel, el sillón de la familia Essentiel, ofrece un asiento de tamaño reducido que sigue las mismas líneas que el sofá homónimo, con formas sin excesos y una ergonomía confortable. Un sillón que evoca la histórica elegancia italiana, combinando elementos sofisticados con una línea esencial. La particular atención por los detalles se aprecia en los cojines acolchados y en el ligero pie pintado que soporta el sillón. También disponible con perfiladura en cinta de canalé. Completamente desenfundable.



p. 243

Poltroncina / Small armchair

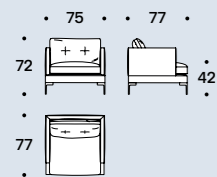

Finitura piedi / Feet finish



1 Grigio / Grey / Gris / Gris
2 Verniciato corten / Painted corten / Peint corten / Pintado corten

it — *Philo* è il prefisso di origine greca che indica amore, propensione e simpatia verso persone o cose. Un filo metallico disegna la sintesi dell'accoglienza, corre, gira, sale e scende, abbraccia e sostiene delicatamente le superfici imbottite. Philo modifica con agilità le sue dimensioni per dare vita a un sistema di sedute capaci di convivere con diversi ambienti: la casa, gli spazi pubblici e in generale i luoghi dell'incontro, dell'accoglienza e delle relazioni. Filantropico per natura si veste con eleganza e semplicità, nelle sue forme asciutte e oneste. Comunica la sua simpatia giocando con le linee e i colori, il filo metallico si trasforma in filo di cucitura e ancora trama e ordito, mescolate e unite in unica armonia. Completamente sfoderabile.

en— *Philo* is a prefix of Greek origins that indicates love, propensity and empathy towards people and things. A metallic thread draws together a welcoming silhouette; it runs, turns, comes up and goes down, hugging and delicately supporting the upholstered surfaces. The agile dimensions give life to a seating system capable of existing in different spaces: home, offices and in places of meeting in general – of welcome and for relationship building. Philanthropic by nature this elegant and simple sofa has a lean yet grounded honest form. The design's character is communicated with an interplay of lines and colours. The metallic thread transforms into sewing thread and continues on to weft and warp creating a singular harmony. Fully removable covers.

fr — *Philo* est le préfixe grec qui indique l'amour, l'attirance et la sympathie envers les personnes ou les choses. Un fil métallique dessine la synthèse de l'accueil, court, tourne, monte et descend, étreint et soutient avec délicatesse les surfaces rembourrées. Philo modifie avec habileté ses dimensions pour donner vie à un système d'assises en mesure de cohabiter dans plusieurs environnements : la maison, les espaces publics et, de manière plus générale, les lieux de rencontre, d'accueil et de relation. Philanthropique par nature, il se pare d'élégance et de simplicité grâce à ses formes épurées et honnêtes. Il communique sa sympathie en jouant avec les lignes et les couleurs, tandis que le fil métallique se transforme en fil de trame et en fil de chaîne, mélangés et unis dans une harmonie unique. Entièrement déhoussable.

es — *Philo* es el prefijo de origen griego que indica amor, propensión y simpatía hacia personas o cosas. Un hilo metálico dibuja la síntesis de acogida, corre, gira, sube y baja, abraza y sostiene de forma delicada las superficies acolchadas. Philo modifica rápidamente sus dimensiones para dar vida a un sistema de asiento capaz de convivir con ambientes diferentes: la casa, los espacios públicos y en general, los lugares de reunión, de acogida y de las relaciones. Filantrópico por naturaleza se viste con elegancia y sencillez, con sus formas puras y honestas. Comunica su simpatía jugando con las líneas y los colores, el hilo metálico se transforma en hilo de coser y trama, mezclados y unidos creando juegos llenos de armonía. Completamente desenfundable.



p. 250

Poltrona / Armchair

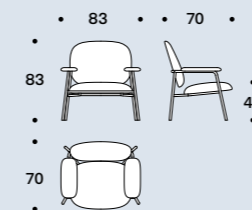

Finitura struttura opaca / Matt frame finish



1 Nero / Black / Noir / Negro

it —La forma asimmetrica della poltrona Kepi, il rigore del disegno e il tratto vagamente nordico si addolciscono sulle sue linee arrotondate, determinando una presenza di carattere oltre che di grande comfort. Il suo design essenziale e l'eleganza disimpegnata lo rendono perfetto sia per l'ambiente domestico che per il contract. La struttura portante a giorno in frassino sbiancato diventa il suo tratto caratterizzante. Disponibile con basamento in tubolare di acciaio verniciato. La collezione Kepi è composta anche da divano due posti e pouf. Completamente sfoderabile.

en — The Kepi armchair's sober design and vaguely Nordic look are softened by rounded lines that add character and improve comfort. Its clean design and nonchalant elegance make it perfect for the home and a contract environments. The structure in bleached ash wood becomes its characteristic trait. The base is also available in varnished tubular stainless steel. The collection also includes a two-seat sofa and a pouf. Fully removable covers.

fr — La forme asymétrique du fauteuil Kepi, le design rigoureux et l'esprit vaguement nordique s'adoucissent en des lignes arrondies, créant une présence de caractère et extrêmement confortable. Son design épuré et son élégance discrète le rendent parfait pour l'espace domestique tout comme pour le contract. La structure portante apparente en frêne blanchi devient son trait caractéristique. Disponible avec piètement en tube d'acier laqué. La collection Kepi est composée également d'un canapé deux places et d'un pouf. Entièrement déhoussable.

es — La forma asimétrica del sillón Kepi, el rigor del diseño y el trazo ligeramente nórdico se suavizan con las líneas redondeadas, determinando una presencia no sólo de carácter sino también de gran confort. Por su diseño esencial y elegancia desinteresada, resulta ideal tanto para el ambiente doméstico como para el contract. La estructura portante abierta de fresno blanqueado se convierte en su rasgo más característico. Disponible con base de tubos de acero pintado. La colección Kepi consiste también en un sofá de dos plazas y un puf. Totalmente desenfundable.

p. 244

Poltrona / Armchair
Base in legno / Wood base

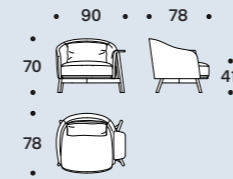

Poltrona / Armchair
Base in metallo / Metal base

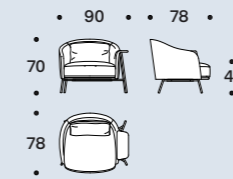

Pouf

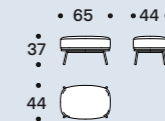

Finitura struttura in legno
/ Wood frame finish

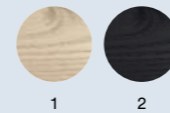

- 1 Frassino sbiancato / Blanched ash / Frêne blanchi / Fresno blanqueado
- 2 Frassino nero opaco / Matt black ash / Frêne noir mat / Fresno negra mate

Finitura struttura in metallo
/ Metal frame finish



- 1 Rosso Bordeaux / Red Bordeaux / Rouge Bordeaux / Rojo Burdeos
- 2 Blu cobalto / Cobalt blue / Bleu cobalt / Azul cobalto
- 3 Grigio / Grey / Gris / Gris



it — Una serie di sedute dal gusto informale con contenuti di praticità e comfort elevati. Le forme morbide, ispirate agli anni '70, rendono Valentine versatile senza trascurare il lato estetico-funzionale. Un appeal estremamente "solido", quasi monolitico, cela un'anima inaspettatamente leggera: una delle sue caratteristiche principali risiede infatti nei materiali scelti per le imbottiture che permettono un facile trasporto dei moduli. Completamente sfoderabile.

en — The soft, 70s inspired shapes make the Valentine armchair versatile while maintaining its aesthetic and functional appeal. A very "solid", almost monolithic quality hides an unexpected lightness: one of its great features is the choice of materials chosen for the padding which allows for easy transportation of the element. Completely removable covers.

fr — Une série de sièges au goût informel avec des contenus d'une praticité et d'un confort incomparables. Les formes moelleuses, s'inspirant des années 70, assurent la polyvalence de Valentine, sans négliger le côté esthétique et fonctionnel. Son aspect compact, presque monolithique, cache une âme étonnamment légère : l'une de ses principales caractéristiques réside en effet dans les matériaux choisis pour le rembourrage qui permettent un transport aisé des éléments. Entièrement déhoussable.

es — Una serie de asientos de gusto informal, muy prácticos y confortables. Las formas suaves, inspiradas en los setenta, hacen de Valentine un modelo versátil, sin olvidar el lado estético-funcional. Una sólida capacidad de atracción, casi monolítica que esconde un alma inesperadamente ligera: una de sus características principales se focaliza en los materiales usados para los rellenos que facilitan el transporte de los módulos. Completamente desenfundable.



p. 254

Poltrona / Armchair

Pouf

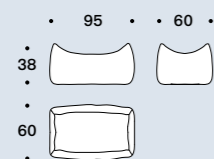
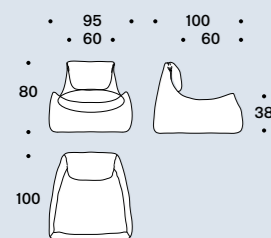

it — La poltroncina Livingston è il giusto complemento all'omonimo divano. Precisa nelle proporzioni, rientra tra gli oggetti che non risentono delle insidie della moda. La struttura in acciaio ben si accosta ai rivestimenti sia in pelle sia in tessuto. Completamente sfoderabile.

en — The Livingston tub chair is the perfect companion to the Livingston sofa. With its balanced proportions, it is one of those objects whose beauty never fades. Its steel frame perfectly matches both leather and fabric upholstery. Fully removable covers.

fr — Le siège Livingston constitue le parfait complément du canapé éponyme. Aux proportions bien pensées, il fait partie des objets qui font fi du temps et des modes passagères. Sa structure en acier est véritablement sublimée par les revêtements proposés, cuir ou tissu. Entièrement déhoussable.

es — El sillón Livingston es el complemento ideal del sofá homónimo. Con sus proporciones precisas, es uno de esos objetos que no se ven influidos por las modas. La estructura de acero se combina perfectamente con los revestimientos de piel o de tejido. Totalmente desenfundable.



p. 256

Poltrona / Armchair

Finitura piedi / Feet finish

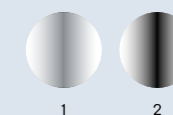
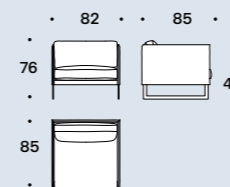

1 Cromo / Chrome / Chrome / Cromo
2 Black nichel / Black nickel / Nickel noir / Niquel negro

it — Ola nasce da un'idea semplice ma al tempo stesso complessa, creare una poltroncina accogliente utilizzando 4 fogli curvi indipendenti tra loro, ciascuno dei quali converge verso un unico centro rappresentato dall'individuo che la utilizza (i fogli diventano 2 per la versione senza braccioli). La struttura in metallo ha un tratto essenziale e grafico in contrasto con le rotondità della parte imbottita. Il prodotto è completamente sfoderabile.

en — Ola originates from a simple idea but at the same time represents a complex concept – a welcoming arm chair created utilising four individual curved sheets. Each sheet converges towards a single centre. Four sheets become two sheets for the variation without arm rests. The metal frame has an essential and graphic silhouette in contrast with the padded rounded forms. The cover is completely removable.

fr — Ola naît d'une idée à la fois simple et complexe : créer un fauteuil accueillant en utilisant 4 feuilles incurvées indépendantes, chacune convergeant vers le centre représenté par l'individu qui l'utilise (dans la version sans accoudoirs, il n'y a que deux feuilles). La structure en métal présente un trait essentiel et graphique, en contraste avec les rondeurs de la partie rembourrée. Le produit est entièrement déhoussable.

es — Ola nace de una idea sencilla al mismo tiempo que compleja, crear un sillón acogedor utilizando 4 hojas curvadas independientes entre sí, cada una de las cuales converge hacia un único centro representado por la persona que las utiliza (las hojas se convierten en 2 en la versión sin reposa brazos). La estructura de metal tiene un trazado esencial y gráfico en contraste con las formas redondeadas de la parte acolchada. El producto puede desenfundarse completamente.

p. 264

Poltroncina con e senza braccioli / Small armchair with and without armrests

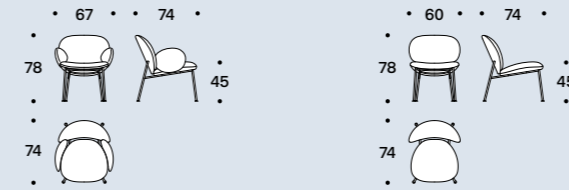

Sedia con e senza braccioli / Chair with and without armrests

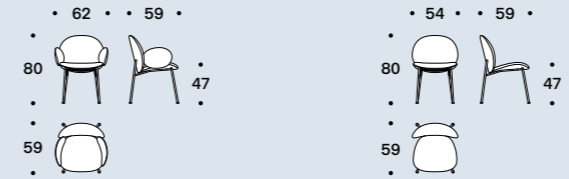

Sgabello alto e basso / High and low stool

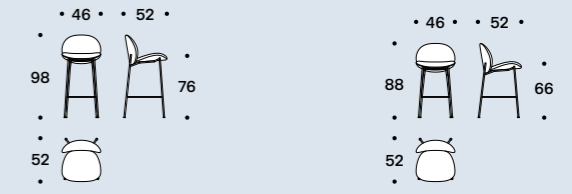

Finitura struttura / Frame finish



- 1 Ottone satinato / Satin brass / Laiton satiné / Latón satinado
- 2 Grigio / Grey / Gris / Gris
- 3 Cromo / Chrome / Chrome / Cromo
- 4 Black nichel / Black nickel / Nickel noir / Níquel negro



it — Poltroncina dalla forma lieve che ricorda l'accoglienza di una piuma, una carezza, una parentesi di armonia realizzata in frassino verniciato e corda nautica intrecciata. Il nome ha origini persiane "seh-tar" letteralmente significa tre corde e trova fonte di ispirazione nello strumento della musica classica indiana più conosciuto in Occidente. Un background lontano per un appeal senza tempo e un design contemporaneo.

en — A light armchair that brings to mind the softness of a feather, a caress, a moment of harmony in ash wood and woven nautical cords. The name has Persian origins: "seh-tar" literally means three strings and the model is inspired by the best known Indian classical music instrument. Faraway origins generating timeless appeal for a modern design.

fr — Fauteuil à la forme légère, qui rappelle la douceur d'une plume, une caresse, une parenthèse d'harmonie réalisée en frêne peint et en cordage nautique tressé. Il tire son nom de l'instrument de musique classique indienne le plus connu d'Occident, dont le nom est dérivé du mot perse « seh-tar », qui signifie littéralement « trois cordes ». Des origines lointaines pour un attrait intemporel et un design contemporain.

es — Butaca de formas ligeras que recuerda a la sensación de una pluma, una caricia, un paréntesis de armonía, fabricada en fresno barnizado y cuerda náutica trenzada. El nombre «seh-tar» tiene origen persa, significa literalmente «tres cuerdas» y se inspira en el instrumento de la música clásica india más conocido en Occidente. Unos orígenes lejanos para un atractivo atemporal y un diseño contemporáneo.



p. 258

Poltrona / Armchair

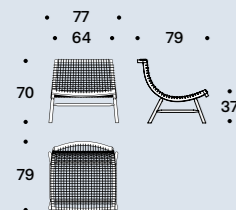

Pouf

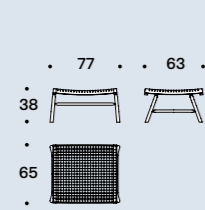

Finitura struttura / Frame finish



1

1 Noce / Walnut / Noyer / Nuez



2

2 Nero / Black / Noir / Negro

Finitura intreccio / Braid finish

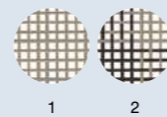

1

1 Monocolore Corda / Cord / Corde / Cuerda
2 Bicolore Corda&Nero / Cord&Black / Corde&Noir / Cuerda&Negro

3

3 Bicolore Grigio&Nero / Grey&Black / Gris&Noir / Gris&Negro

it — Pouf Geo è un accessorio che si colloca idealmente in ogni contesto abitativo e contract. Un elemento passepartout in grado di dialogare con stili eterogenei grazie a un semplice cambio d'abito e a un campionario tessile estremamente ricercato. Geo è un pouf che dona un tocco di colore e di personalità a ogni ambiente, creando allo stesso tempo delle facili sedute extra. La struttura metallica su cui poggia impreziosisce il progetto garantendo inoltre una maggiore pulizia. Completamente sfoderabile.

en — Geo pouf is an accessory that can be placed in any home and contract environment. It is a versatile element that can connect with diverse styles with a simple change of upholstery and choice of exclusive fabrics. Geo is a pouf that adds a touch of color and personality to any environment, while creating easy extra seating. The metal structure on which it rests enhances the design and even facilitates better cleaning. Fully removable covers.

fr — Le pouf Geo est un accessoire qui s'intègre parfaitement dans n'importe quel espace domestique ou contract. Un élément passe-partout en mesure de dialoguer avec des styles hétérogènes grâce à un simple changement de revêtement et une proposition textile extrêmement raffinée. Geo est un pouf qui apporte une touche de couleur et de personnalité aux pièces, créant dans le même temps des assises supplémentaires. Sa structure métallique enrichit le projet et garantit une plus grande propreté. Entièrement déhoussable.

es — El puf Geo es un accesorio que se coloca idealmente en cualquier ambiente doméstico o contract. Un cómodo que dialoga con estilos heterogéneos gracias a un simple cambio de hábito y a un muestrario textil extremadamente refinado. Geo es un puf que aporta un toque de color y personalidad a cualquier ambiente, creando al mismo tiempo asientos adicionales. La estructura metálica de apoyo enriquece el proyecto garantizando asimismo una mayor pulcritud. Totalmente desenfundable.



p. 268

Pouf

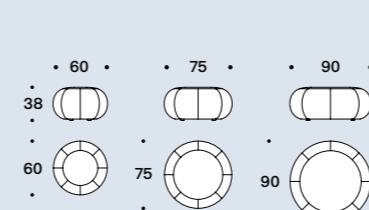

Pouf con telaio / Pouf with frame

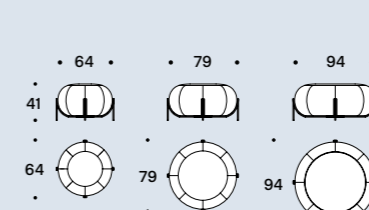

Finitura struttura / Frame finish

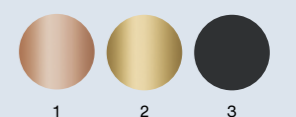

1

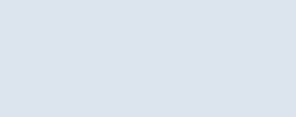
1 Rame lucido / Glossy copper / Cuivre brillant / Cobre brillante
2 Ottone satinato / Satin brass / Laiton satiné / Latón satinado
3 Grigio / Grey / Gris / Gris

2

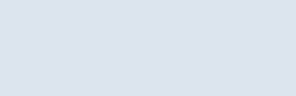

3

Island

design Serena Confalonieri

it — Island è una collezione composta da tre pouf le cui forme organiche richiamano le linee curve delle coste lambite dal mare. Il rimando si fa sentire non solo in pianta, ma su tutte le dimensioni, a ricordare il movimento avvolgente dell'acqua che leviga e modella le pietre. Per questo motivo i volumi vengono percepiti in maniera differente nello spazio a seconda della prospettiva da cui vengono osservati. Lo zoccolo stacca visivamente la seduta da terra e la lascia fluttuare nello spazio. Completamente sfoderabile.

en — Island is a collection made up of three poufs with organic forms that evoke the coast line lapped by the sea. This imagery is felt throughout the entire design, conjuring the enveloping movement of the tide which softens and shapes the shore. For this reason, the volumes are perceived differently depending on the perspective from which they are observed in a space. The base visually elevates the seat from the ground making it seem like it's floating in space. Fully removable covers.

fr — Island est une collection composée de trois poufs dont les formes organiques rappellent les lignes courbes des côtes léchées par la mer. Cela se ressent non seulement dans la vue en plan, mais aussi dans toutes les dimensions, qui évoquent le mouvement enveloppant de l'eau qui polit et modèle les pierres. C'est pourquoi les volumes sont perçus de manière différente dans l'espace selon la perspective depuis laquelle on les observe. Le socle permet de détacher l'assise du sol et de donner l'impression qu'elle flotte dans l'espace. Entièrement déhoussable.

es — Island es una colección compuesta por tres pufs cuyas formas orgánicas recuerdan a las líneas curvas de las costas lamidas por el mar. La referencia se hace sentir no solo en la planta, sino en todas las dimensiones, recordando al movimiento envolvente del agua que pule y da forma a las piedras. Por este motivo, los volúmenes se perciben de una manera diferente en el espacio dependiendo de la perspectiva desde la que se observen. La base separa visualmente el asiento del suelo y lo deja fluctuar en el espacio. Completamente desenfundable.



p. 270

Pouf

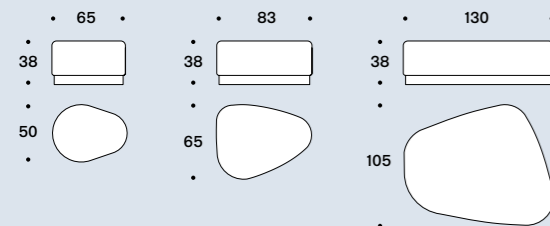

Finitura base / Base finish



1 Verniciato ottone
/ Painted brass
/ Peint laiton
/ Pintado latón

Cookie

design Sergio Bicego

Saba

it — Una nuova evoluzione nella famiglia di pouf firmati Saba, Cookie è disponibile in formato rotondo o quadrato ed è caratterizzato da un'evidente ma leggera trapuntatura sulla seduta. Cookie è un pouf versatile, può esistere in modo indipendente ma si presta anche ad essere accostato ad altri elementi. Completamente sfoderabile.

en — A new evolution of Saba poufs, Cookie are available in a round or square format and are characterized by the light quilting on the seating area. The Cookie poufs are fun and independent elements, that can exist on their own or be placed nearby other products. The cover is completely removable.

fr — Nouvelle évolution dans la famille de poufs signés Saba, le modèle Cookie est disponible en format rond ou carré et est caractérisé par un matelassage visible mais léger sur l'assise. Cookie est un pouf polyvalent, qui peut exister de manière indépendante mais se prête aussi à être associé à d'autres éléments. Entièrement déhoussable.

es — Una nueva evolución en la familia de los pufs firmados Saba, Cookie está disponible en formato redondo o cuadrado, y se caracteriza por un acolchado evidente a la vez que ligero en el asiento. Cookie es un puf versátil, puede funcionar de forma independiente pero también se presta a ser combinado con otros elementos. Completamente desenfundable.



p. 272

Pouf

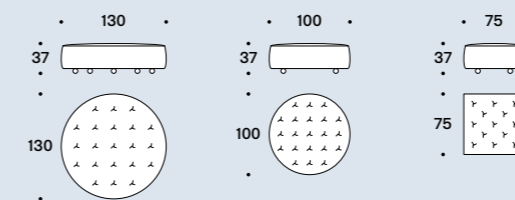

Pixel Pouf

design Sergio Bicego

it — Dal nostro divano best seller Pixel nasce un nuovo elemento, il Pixel pouf. Un singolo modulo forma una seduta semplice e minimale che segue le stesse forme eleganti e generose dell'iconico divano. Completamente sfoderabile.

en — From our best selling Pixel sofa stems a new element, the Pixel pouf. One single module from the geometrical sofa forms a simple and minimal seating element that follows the same elegant and generous shape as the iconic sofa. Fully removable covers.

fr — De notre canapé best-seller Pixel est né un nouvel élément : le Pouf Pixel. Ce module indépendant constitue une assise simple et minimaliste qui possède les mêmes formes élégantes et généreuses que le canapé emblématique du même nom. Entièrement déhoussable.

es — A partir de nuestro sofá best seller Pixel, nace un nuevo elemento, el Pixel puf. Un solo módulo forma un asiento simple y minimalista que sigue las mismas formas elegantes y generosas del emblemático sofá. Completamente desenfundable.



p. 276

Pouf

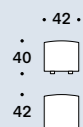

Honey

design Fabio Calvi e Paolo Brambilla

Saba

it — Una piccola cella esagonale, questo è Honey. Ogni elemento ha una propria autonomia formale – funzionale e può essere utilizzato singolarmente. Ma non solo. Honey è un progetto perfettamente modulare, con la possibilità di accostare più moduli a formare un vero alveare. Honey è realizzato artigianalmente tramite un procedimento sartoriale. Completamente sfoderabile.

en — Eclectic by nature, the Honey pouf appears to be a small hexagonal cell that adapts to the needs of the moment. Honey features a seamless modular design, and the various elements can be attached and combined to form a veritable honeycomb. Honey is an artisanal product, created using a sartorial process. Fully removable covers.

fr — Une petite cellule hexagonale, voilà ce qu'est Honey. Chaque élément a sa propre autonomie formelle et fonctionnelle et peut être utilisé individuellement. Mais ce n'est pas tout. Honey est un projet parfaitement modulaire, avec la possibilité de juxtaposer plusieurs modules de manière à former une véritable ruche. Entièrement déhoussable.

es — Una pequeña celda hexagonal, esto es Honey. Cada elemento dispone de una propia autonomía formal y funcional y puede utilizarse individualmente. Pero no sólo esto. Honey es un proyecto perfectamente modular, con la posibilidad de adosar varios módulos que componen una verdadera colmena. Completamente desenfundable.



p. 278

Pouf

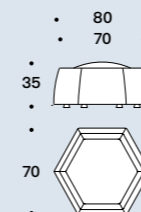

it — Raffinato complemento per la zona pranzo, la sedia New York con o senza braccioli, si distingue per l'agile struttura e la confortevole imbottitura impreziosita da piccole trapuntature tono su tono. Disponibile con finitura cromata o verniciata. Completamente sfoderabile.

en — A sophisticated item of furniture for the dining area, the New York chair with or without armrests stands out with its sprightly structure and comfortable upholstery embellished by small tonal quilted parts. Available in chrome or painted finish. Fully removable covers.

fr — Complément raffiné pour la zone déjeuner, la chaise New York avec ou sans accoudoirs, est caractérisée par sa structure fine et par le confortable rembourrage enrichi par de petits matelassages ton sur ton. Disponible dans une finition chromée ou laquée. Entièrement déhoussable.

es — Complemento refinado para la zona de comer, la silla New York con o sin brazos se distingue por la ágil estructura y el confortable acolchado, embellecido por pespunteados diminutos tono sobre tono. Disponible con acabado cromado o pintado. Completamente desfundable.

p. 282

Sedia con e senza braccioli / Chair with or without armrests

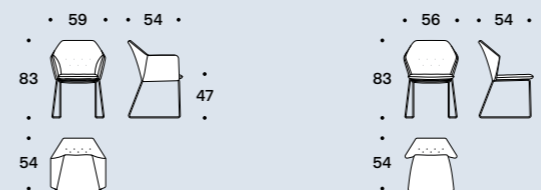

p. 294

New York Chair by Marras



Volti by Marras dis.1



Volti by Marras dis.2



Volti by Marras dis.3



Volti by Marras dis.4

Finitura struttura / Frame finish

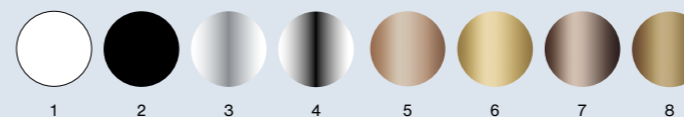

- | | |
|--|---|
| 1 Bianco / White / Blanc / Blanco | 5 Rame lucido / Glossy copper / Cuivre brillant / Cobre brillante |
| 2 Nero / Black / Noir / Negro | 6 Ottone satinato / Satin brass / Laiton satiné / Latón satinado |
| 3 Cromo / Chrome / Chrome / Cromo | 7 Bronze copper matt |
| 4 Black nichel / Black nickel / Nickel noir / Níquel negro | 8 Bronze gold matt |



New York Dining design Sergio Bicego

it — La famiglia New York accoglie una nuova proposta di seduta particolarmente idonea per gli ambienti contract. New York Dining, la panca a due posti con o senza braccioli mantiene l'agile struttura di tutta la collezione oltre alla confortevole imbottitura che si distingue per la delicata trapuntatura tono su tono. Disponibile con finitura cromata o verniciata. Completamente sfoderabile.

en — The New York family adds yet another seating solution to the dining area collection. New York Dining is a two-seater bench with integrated armrests that maintains the collection's agile structure as well as the comfortable upholstery distinguished by small tonal quilted parts. Available in chrome or painted finish. Fully removable covers.

fr — La famille New York accueille un nouveau type d'assise particulièrement bien adapté aux environnements professionnels. New York Dining, la banquette à deux places avec ou sans accoudoirs conserve la structure agile qui caractérise toute la collection, en plus d'un rembourrage confortable qui se distingue par un délicat matelassage ton sur ton. Disponible en finition chromée ou laquée. Entièrement déhoussable.

es — La familia New York acoge una nueva propuesta de asiento especialmente adecuada para ambientes contract. New York Dining, el asiento de dos plazas con o sin posabrazos, mantiene la estructura ágil de toda la colección además de un confortable acolchado que se distingue por el delicado pespunte tono sobre tono. Disponible con acabado cromado o pintado. Totalmente desenfundable.



pp. 182, 282

Panchetta con e senza braccioli / Bench with and without armrests



Finitura struttura / Frame finish



- 1 Bianco / White / Blanc / Blanco
- 2 Nero / Black / Noir / Negro
- 3 Cromo / Chrome / Chrome / Cromo
- 4 Black nichel / Black nickel / Nickel noir / Niquel negro

New York Stool design Sergio Bicego

Saba

it — La collezione New York amplia la propria proposta con una linea di sgabelli, il cui design è lo sviluppo in altezza della medesima sedia senza braccioli. Il risultato è un progetto che enfatizza ancor più l'agile struttura, mantenendo confortevole la consueta imbottitura che viene impreziosita di piccole trapuntature tono su tono. Disponibile con finitura cromata o verniciata. Completamente sfoderabile.

en — The New York chair grows taller to transform into a high stool, emphasizing even more the agile structure of the line. The quilted details on the backrest maintain a constant design aesthetics within the entire New York collection. Available in chrome or painted finish. Fully removable covers.

fr — La collection New York élargit sa proposition avec une ligne de tabourets, dont le design est un développement en hauteur de la chaise sans accoudoirs du même nom. Le résultat est un projet qui souligne encore plus la fine structure, tout en conservant le confort du rembourrage rehaussé de petites matelassures ton sur ton. Disponible dans une finition chromée ou laquée. Entièrement déhoussable.

es — La colección New York amplía su propuesta con una línea de taburetes cuyo diseño se basa en el desarrollo de la altura de la silla sin brazos. El resultado es un proyecto que enfatiza aún más la ágil estructura, manteniendo confortable el relleno habitual, decorado con pequeños pespuntos tono sobre tono. Disponible con acabado cromado o pintado. Totalmente desenfundable.



p. 292

Sgabello alto e basso / High and low stool

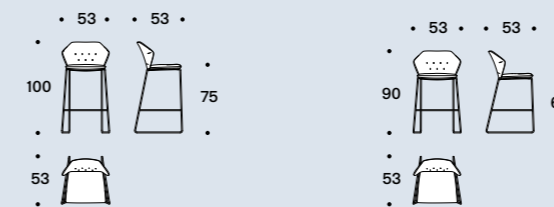

Finitura struttura / Frame finish

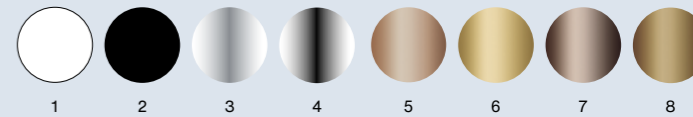

- 1 Bianco / White / Blanc / Blanco
- 2 Nero / Black / Noir / Negro
- 3 Cromo / Chrome / Chrome / Cromo
- 4 Black nichel / Black nickel / Nickel noir / Niquel negro
- 5 Rame lucido / Glossy copper / Cuivre brillant / Cobre brillante
- 6 Ottone satinato / Satin brass / Laiton satiné / Latón satinado
- 7 Bronze copper matt
- 8 Bronze gold matt

Ola Chair

design Team Saba Project
(Resp. Nicola Pavan)

it — La famiglia Ola si estende alla sala da pranzo: Ola sedia nasce dalla stessa idea di fogli curvi che convergono verso un unico centro. I fogli diventano 2 per la versione senza braccioli. La struttura in metallo ha un tratto essenziale e grafico in contrasto con le rotondità della parte imbottita. Completamente sfoderabile.

en — The Ola family extends to the dining room: Ola chair originates from the same concept of curved sheets, each converging towards a single center point. Four sheets become two sheets for the variation without armrests. The metal frame has an essential and graphic silhouette, in contrast with the padded and rounded form. Fully removable covers.

fr — La famille Ola s'étend à la salle à manger : la chaise Ola est un nouveau modèle né de la même idée de feuilles incurvées qui convergent vers un centre unique. Dans la version sans accoudoirs, il n'y a que 2 feuilles. La structure en métal présente un trait essentiel et graphique, qui contraste avec les rondeurs de la partie rembourrée. Entièrement déhoussable.

es — La familia Ola se extiende hasta el comedor: La silla Ola nace a partir de la misma idea de hojas curvadas que convergen hacia un único centro. Las hojas se convierten en 2 en la versión sin posabrazos. La estructura de metal tiene un trazado esencial y gráfico en contraste con las formas redondeadas de la parte acolchada. Totalmente desenfundable.



p. 300

Sedia con e senza braccioli / Chair with and without armrests

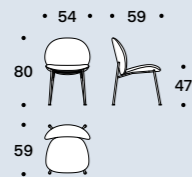
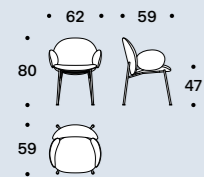

Finitura struttura / Structure finish



- 1 Ottone satinato / Satin brass / Laiton satiné / Latón satinado
- 2 Grigio / Grey / Gris / Gris
- 3 Cromo / Chrome / Chrome / Cromo
- 4 Black nichel / Black nickel / Nickel noir / Níquel negro

506

Ola Stool

design Team Saba Project
(Resp. Nicola Pavan)

it — Lo sgabello Ola adotta lo stesso concetto di fogli curvi che convergono verso un unico centro. La forma accogliente ed imbottita della collezione Ola si estende ad un nuovo uso nella zona pranzo, disponibile in due altezze diverse e pensato per uso residenziale e commerciale. La struttura in metallo ha un tratto essenziale e grafico in contrasto con le rotondità della parte imbottita. Completamente sfoderabile.

en — The Ola chair grows taller: it adapts the same concept of curved sheets converging towards a single central point but this time in the form of a stool. The padded and welcoming form of the Ola collection extends to a different use within the dining area, available in two different heights, intended for both residential and commercial use. Fully removable covers.

fr — Le tabouret Ola adopte le même concept de feuilles incurvées qui convergent vers un centre unique. La forme accueillante et rembourrée de la collection Ola s'étend à un nouvel usage dans l'espace repas. Disponible en deux hauteurs différentes, ce modèle a été imaginé pour un usage résidentiel et commercial. La structure en métal présente un trait essentiel et graphique, qui contraste avec les rondeurs de la partie rembourrée. Entièrement déhoussable.

es — El taburete Ola adopta el mismo concepto de hojas curvadas que convergen hacia un único centro. La forma acogedora y acolchada de la colección Ola se extiende a un nuevo uso en la zona comedor, disponible en dos alturas distintas y concebido para uso residencial y comercial. La estructura de metal tiene un trazado esencial y gráfico en contraste con las formas redondeadas de la parte acolchada. Totalmente desenfundable.



p. 307

Sgabello alto e basso / High and low stool

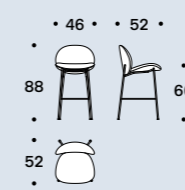
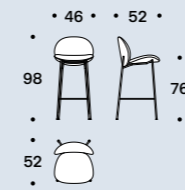

Finitura struttura / Structure finish



- 1 Ottone satinato / Satin brass / Laiton satiné / Latón satinado
- 2 Grigio / Grey / Gris / Gris
- 3 Cromo / Chrome / Chrome / Cromo
- 4 Black nichel / Black nickel / Nickel noir / Níquel negro

507

Chairs & Stools

Isabelle Chair

design Team Saba Project

it — Una sedia come un piccolo racconto femminile: discreta e raffinata, calma e semplice. Una cover tonda accentuata dalla sartorialità del tessuto, velluto in esterno e jacquard boucle all'interno. Completamente sfoderabile.

en— A whimsical, feminine seat: discreet and refined, calm and simple. The rounded shape is accentuated by the sumptuous fabric, velvet on the outside and boucle jacquard on the inside. Fully removable covers.

fr — Un siège qui évoque une petite histoire féminine : discrète et raffinée, calme et simple. Une housse ronde mise en valeur par l'aspect haute couture du tissu, en velours à l'extérieur et jacquard bouclé à l'intérieur. Entièrement déhoussable.

es — Una silla con las características de un pequeño cuento femenino: discreta y refinada, serena y sencilla. Una cubierta redonda acentuada por la sastrería del tejido, terciopelo en el exterior y jacquard boucle en el interior. Totalmente desenfundable.



p. 308

Sedia / Chair

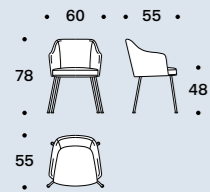

Finitura struttura / Structure finish



- 1 Ottone satinato / Satin brass / Laiton satiné / Latón satinado
- 2 Nero opaco / Matt black / Noir mate / Negro mate
- 3 Cromo / Chrome / Chrome / Cromo
- 4 Black nichel / Black nickel / Nickel noir / Niquel negro

Isabelle Stool

design Team Saba Project

it — Il racconto femminile e raffinato delle sedie Isabelle si declina nella variante sgabello. Discreto e semplice, presenta la stessa forma organica e delicata dell'omonima sedia, accentuata dalla sartorialità del tessuto. La sua altezza di 96 cm lo rende perfetto per uso commerciale. Completamente sfoderabile.

en — The whimsical and feminine touch that defines the Isabelle chairs has been elevated in the form of a stool element. The stool maintains the organic shape that characterizes the seating solution, accentuated by the lavish upholstery: velvet and boucle jacquard. The 96 cm height make it perfect for commercial use. Fully removable covers.

fr — Le récit féminin et raffiné des chaises Isabelle se décline dans une variante tabouret. Discret et simple, ce modèle possède la même forme organique et délicate que la chaise du même nom, accentuée par l'aspect haute couture du tissu. Sa hauteur de 96 cm le rend parfait pour un usage commercial. Entièrement déhoussable.

es — Las formas femeninas y refinadas de las sillas Isabelle se presentan en la variante taburete. Discreto y sencillo, presenta la misma forma orgánica y delicada de la silla homónima, en el que se pone de relieve la sastrería del tejido. Su altura de 96 cm hace que sea ideal para uso comercial. Totalmente desenfundable.



p. 311

Sgabello / Stool

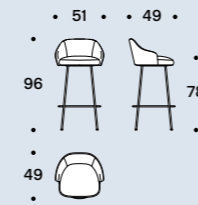

Finitura struttura / Structure finish



- 1 Ottone satinato / Satin brass / Laiton satiné / Latón satinado
- 2 Nero opaco / Matt black / Noir mate / Negro mate
- 3 Cromo / Chrome / Chrome / Cromo
- 4 Black nichel / Black nickel / Nickel noir / Niquel negro

it – **Posizione 1:** nella prima posizione il meccanismo porta la rete obliqua e permette un comodo accesso al box contenitore (figura 1).

Posizione 2: dalla posizione 1 con un semplice scatto, la rete si posiziona orizzontalmente al pavimento, permettendo di lavorare sul materasso con una postura verticale (figura 2). Non sporgendo frontalmente dalla pediera, l'ingombro della rete rimane sempre all'interno delle dimensioni del letto (figura 3).

en – **Position 1:** in position 1 the mechanism puts the slatted base obliquely and allows an easy access to the box container (picture 1).

Position 2: from position 1, the slatted base is positioned horizontally to the floor by a simple click, allowing to operate on the mattress with a vertical posture (picture 2). As the slatted base does not stick out of the foot bed, the slatted base footprint remains within the bed dimensions (picture 3).

fr – **Position 1:** dans la première position le mécanisme met le sommier à lattes obliquement et permet un accès confortable à la boîte de rangement (image 1).

Position 2: à partir de la position 1, par un simple mouvement, le sommier se place horizontalement au sol, en permettant de travailler sur le matelas avec une posture verticale (image 2). Comme le sommier ne sorte pas du pied de lit, l'encombrement du sommier reste toujours à l'intérieur des dimensions du lit (image 3).

es – **Posición 1:** en la primera posición el mecanismo pone el somier con tablas oblicuamente y permite un cómodo acceso a la caja de almacenamiento (imagen 1).

Posición 2: a partir de la posición 1, por medio de un simple movimiento, el somier se posiciona horizontalmente al suelo, permitiendo de trabajar sobre el colchón en postura vertical. (imagen 2). Como el somier no sobresale del pie de cama, el envolverte del somier queda siempre dentro de las dimensiones de la cama (imagen 3).

it – **Angolari:** gli angolari di supporto delle reti permettono, in assenza del meccanismo di sollevamento, di essere regolati in 6 differenti altezze a discrezione del cliente (figura 4). In presenza del meccanismo, è consentita un'unica posizione degli angolari (figura 5).

en – **Angle irons:** in the absence of the lifting mechanism, the support angle irons of the bed bases can be adjusted in 6 different heights at the user's discretion (picture 4). In presence of mechanism, only one angle irons position is allowed (picture 5).

fr – **Cornières:** les cornières de support des sommiers permettent en l'absence de mécanisme de levage de les régler en 6 différents hauteurs à la discretion du client (image 4). En présence de mécanisme, on peut avoir une unique position des cornières de support (image 5).

es – **Perfiles metálicos en forma de L:** los perfiles metálicos en forma de L de apoyo a los somiers permiten a falta de mecanismo de levantamiento de regularlos en 6 diferentes alturas a elección del cliente (imagen 4). En presencia de mecanismo, está permitida una única posición de los perfiles metálicos (imagen 5).



it — Pixel Box Large è la proposta più voluminosa della collezione notte Pixel, completamente avvolto dal generoso e morbido giroletto. Il letto Pixel Box Large è la versione che più evidentemente richiama il divano Pixel e la sua iconica cucitura trapuntata. Completamente sfoderabile

en — Pixel Box Large is the most voluminous option in the Pixel bed collection, completely enclosed by the soft and ample bed frame. Pixel Box Large most evidently recalls the iconic and generous rounded shapes of Saba's Pixel sofa. Fully removable covers.

fr — Pixel Box Large est le modèle le plus volumineux de la collection nuit Pixel, entièrement entouré d'un tour de lit généreux et moelleux. Le lit Pixel Box Large est la version qui rappelle de la manière la plus évidente le canapé Pixel et sa couture matelassée emblématique. Entièrement déhoussable.

es — Pixel Box Large es la propuesta más voluminosa de la colección noche Pixel, completamente envuelto por el generoso y suave cubre somier. La cama Pixel Box Large es la versión que más evidentemente evoca el sofá Pixel y su emblemática costura pespunteada. Completamente desenfundable.



p. 314

Misura rete / Size for Bed base - 160x200 cm

153x203 cm

180x200 cm

193x203 cm

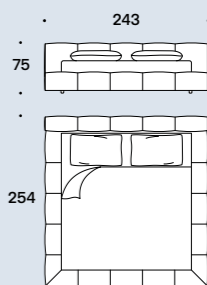
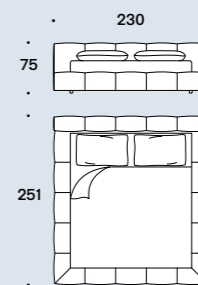
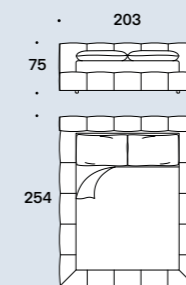
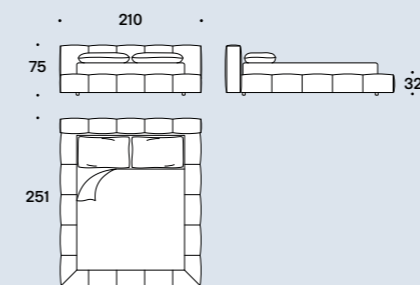

Pixel Box

design Sergio Bicego

it — Pixel Box è un letto morbido a tutti gli effetti: accogliente al tatto, grazie alla generosa imbottitura della cornice in tessuto accoppiato a una ovatta di forte spessore e piacevole alla vista grazie ai suoi angoli arrotondati. Il giroletto e la testiera sono caratterizzati dalla particolare cucitura trapuntata che ricorda l'omonimo divano. Completamente sfoderabile.

en — Pixel Box is soft in the entirety of its design. It offers a generous and comforting single volume thanks to the ample padding of the upholstered structure and rounded corners. The bed-frame and the headboard are characterised by the quilted seams that recall Saba's iconic Pixel sofa. Fully removable covers.

fr — Pixel box est un lit moelleux à tous les égards : accueillant au toucher, grâce au rembourrage généreux du cadre en tissu, associé à une forte épaisseur d'ouate, et agréable à regarder avec ses angles arrondis. Le tour et la tête de lit se distinguent par une couture matelassée particulière qui évoque le canapé homonyme. Entièrement déhoussable.

es — Pixel Box es una cama suave a todos los efectos: acogedora al tacto gracias al generoso acolchado del marco de tela con fibra sintética espesa y agradable a la vista gracias a las esquinas redondeadas. El cubre somier y el cabecero tienen un acolchado cosido que recuerda al homónimo sofá. Completamente desenfundable.



p. 320

Misura rete / Size for Bed base – 160x200 cm

153x203 cm

180x200 cm

193x203 cm

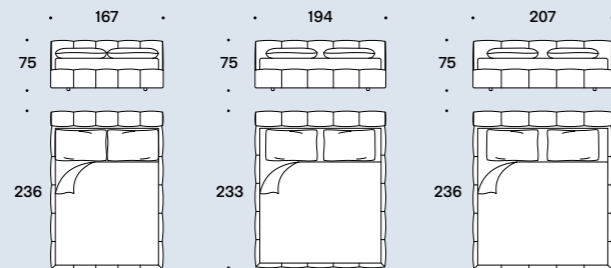
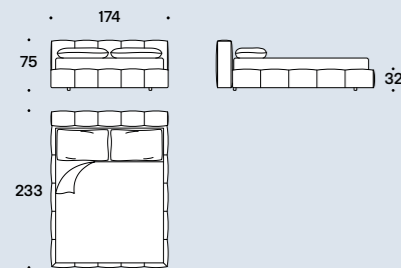

514

Pixel Air

design Sergio Bicego

Saba

it — Pixel Air è la visione estetica leggera delle collezioni Pixel, caratterizzata da una base sollevata da terra da quattro piedini. Il giroletto lineare ed essenziale, dona una nota di leggerezza alla testiera voluminosa che rimane costante nella linea e caratterizzata dalla cucitura trapuntata. Completamente sfoderabile.

en — Pixel Air offers a lighter aesthetic to the Pixel collection, distinguished by being delicately rested on four feet. A linear and essential frame plays with the large and generous headboard that remains constant in the collection and is characterised by the quilted seams. Fully removable covers.

fr — Pixel Air incarne la vision esthétique légère de la collection Pixel, caractérisée par une base soulevée du sol par quatre pieds. Le tour de lit linéaire et essentiel donne une note de légèreté à la tête de lit volumineuse, commune à tous les modèles de la ligne et caractérisée par une couture matelassée. Entièrement déhoussable.

es — Pixel Air es la visión estética ligera de la colección Pixel, caracterizada por una base levantada del suelo por cuatro pies. El cubre somier lineal y esencial da un toque de ligereza al cabecero voluminoso, que se mantiene constante en la línea y se caracteriza por la costura pespunteada. Completamente desenfundable.



p. 324

Misura rete / Size for Bed base – 160x200 cm

153x203 cm

180x200 cm

193x203 cm

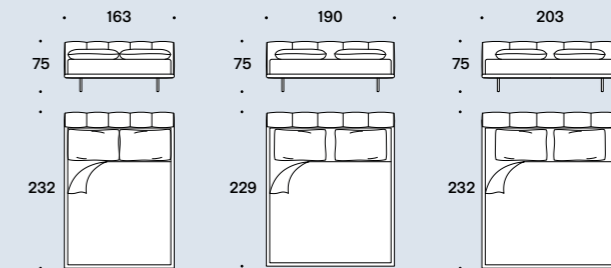
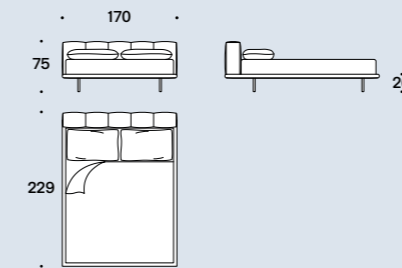

515

Beds & Sofa Beds

Finiture piedi / Feet finish



- 1 Grigio chiaro / Light grey / Gris clair / Gris claro
- 2 Testa di moro / Dark brown / Marron foncé / Marrón oscuro

New York Air

design Sergio Bicego

it — Il letto New York Air segue la stessa linea stilistica dell'omonimo divano con la sua eleganza retrò unita ad un'anima contemporanea e a uno spirito senza tempo. Un letto dalla duplice identità, caratterizzato dalla forma esagonale e i dettagli trapuntati della testiera. New York Air poggia su un agile piedino a slitta. Completamente sfoderabile.

en — The New York Air bed follows the same line of the sofa collection exhibiting all its retro elegance mixed with a contemporary soul and timeless spirit. A bed of two identities and characterised by the hexagonal shape and quilted detailing of the headboard, New York Air rests on a sled base. Fully removable covers.

fr — Le lit New York Air suit la même ligne stylistique que le canapé homonyme, avec son élégance rétro associée à une âme contemporaine et à un esprit intemporel. Un lit à l'identité double, caractérisé par la forme hexagonale et les détails matelassés de la tête de lit. New York Air repose sur un pied coulissant. Entièrement déhoussable.

es — La cama New York Air sigue la misma línea estilística del sofá homónimo, con su elegancia retro unida a un espíritu contemporáneo e intemporal. Una cama de doble identidad, caracterizada por la forma hexagonal y los detalles pespunteados del cabecero. New York Air se apoya sobre un ágil pie corredero. Completamente desenfundable.

New York Box

design Sergio Bicego

Saba

it — La variante con giroletto a terra offre un'opzione più generosa ed esprime l'identità classica del modello New York, mantenendo l'iconica testata con trapuntatura. Completamente sfoderabile.

en — The variation with a floor bed frame offers a fuller option and expresses the classic identity of the New York line, maintaining the iconic quilted headrest. Fully removable covers.

fr — La variante avec tour de lit au sol offre une version plus généreuse et exprime l'identité classique du modèle New York, tout en conservant l'emblématique tête de lit matelassée. Entièrement déhoussable.

es — La variante con cubre somier de suelo ofrece una opción más generosa y expresa la identidad clásica del modelo New York manteniendo el emblemático cabecero con pespunteado. Completamente desenfundable.

Finitura piedi / Feet finish

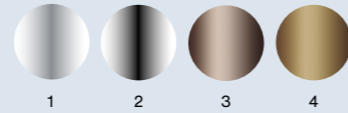

- 1 Cromo / Chrome / Chrome / Cromo
- 2 Black nichel / Black nickel / Nickel noir / Niquel negro
- 3 Bronze copper matt
- 4 Bronze gold matt



p. 330

Misura rete / Size for Bed base – 160x200 cm

153x203 cm

180x200 cm

193x203 cm

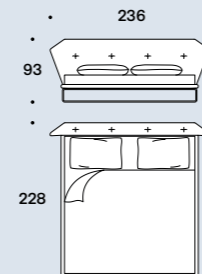
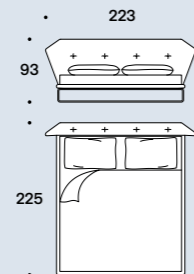
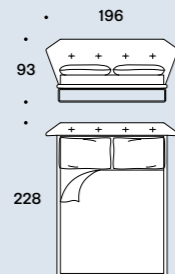
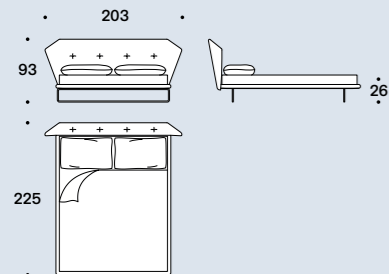

516

p. 336

Misura rete / Size for Bed base – 160x200 cm

153x203 cm

180x200 cm

193x203 cm

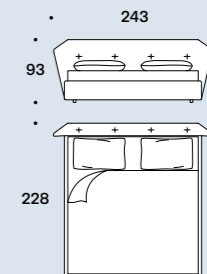
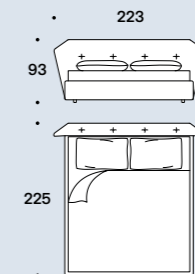
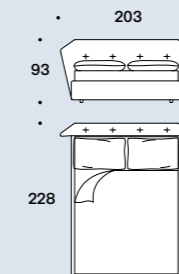
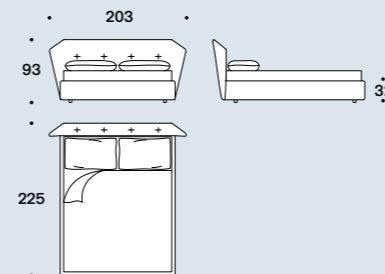

517

Beds & Sofa Beds

it – Limes Large è la proposta più generosa della collezione Limes, grazie ai due lati più ampi che consentono un funzionale e insolito appoggio. Le sezioni rettangolari in metacrilato trasparente su cui è appoggiata la base, danno l'illusione che il letto galleggi. Completamente sfoderabile.

en – Limes Large is the most generous option within the Limes collection, thanks to the two wider sides that allow for a functional and unusual support. The rectangular feet in transparent methacrylate onto which the base is rested, make the bed appear to float. Fully removable covers.

fr – Limes Large est le modèle le plus généreux de la collection Limes, grâce à deux côtés plus larges qui offrent une surface d'appui fonctionnelle et insolite. Les sections rectangulaires en méthacrylate transparent sur lesquelles repose la base donnent l'illusion que le lit est en train de flotter. Entièrement déhousable.

es – Limes Large es la propuesta más generosa de la colección Limes, gracias a los dos lados más amplios, que permiten un apoyo funcional e insólito. Las secciones rectangulares de metacrilato transparente donde se apoya la base dan la ilusión de que la cama flota. Completamente desfundable.

Finitura piedi / Feet finish



1

1 Metacrilato / Methacrylate / Méthacrylate / Metacrilato

Finitura struttura pannelli testiera / Frame headboard panels finish



1

1 Cromo / Chrome / Chrome / Cromo



p. 338

Esempi posizione pannelli testiera / Examples headboard panels position

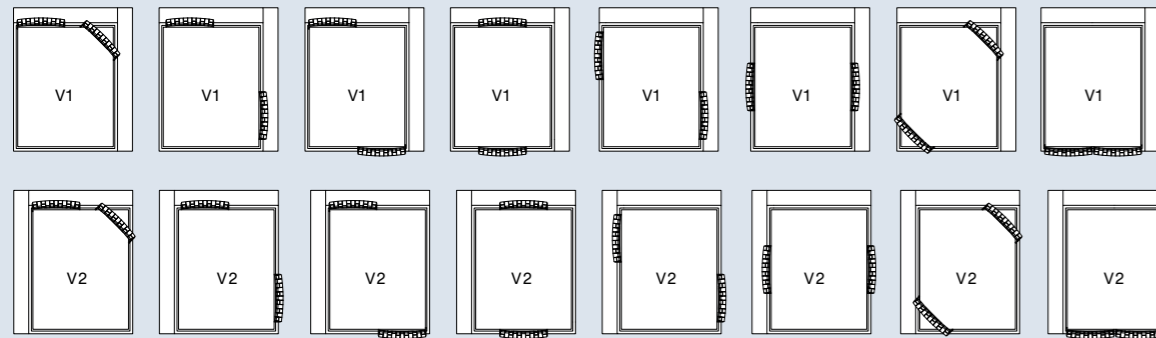

A B C D E F G H

Misura rete / Size for bed base – 160x200 cm

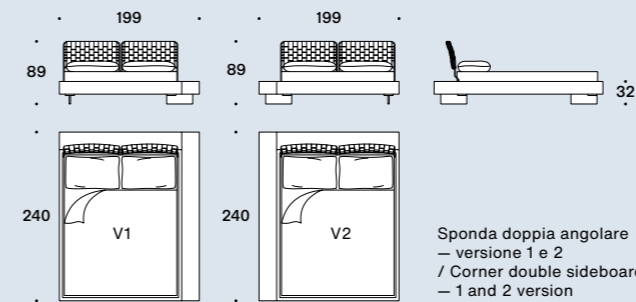

Sponda doppia angolare
– versione 1 e 2
/ Corner double sideboard
– 1 and 2 version

Testiera / Headboard

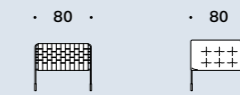

Fasce imbottite / Padded bands
Tessuto trapuntato / Quilted fabric

Fianco con testiera tessuto trapuntato / Side with quilted fabric headboard



Misura rete / Size for bed base – 153x203 cm

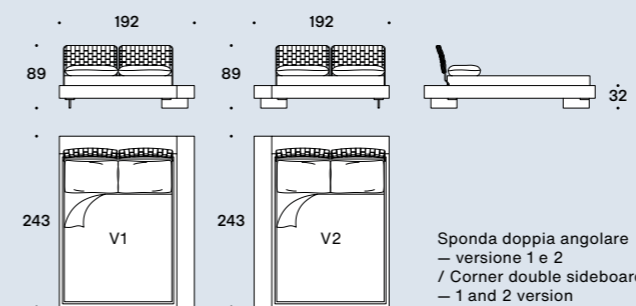

Sponda doppia angolare
– versione 1 e 2
/ Corner double sideboard
– 1 and 2 version

Testiera / Headboard



Fasce imbottite / Padded bands
Tessuto trapuntato / Quilted fabric

Fianco con testiera tessuto trapuntato / Side with quilted fabric headboard

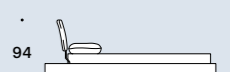

Misura rete / Size for bed base – 180x200 cm

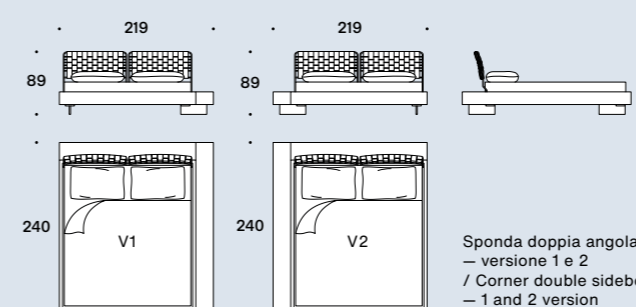

Sponda doppia angolare
– versione 1 e 2
/ Corner double sideboard
– 1 and 2 version

Testiera / Headboard



Fasce imbottite / Padded bands
Tessuto trapuntato / Quilted fabric

Fianco con testiera tessuto trapuntato / Side with quilted fabric headboard



Misura rete / Size for bed base – 193x203 cm

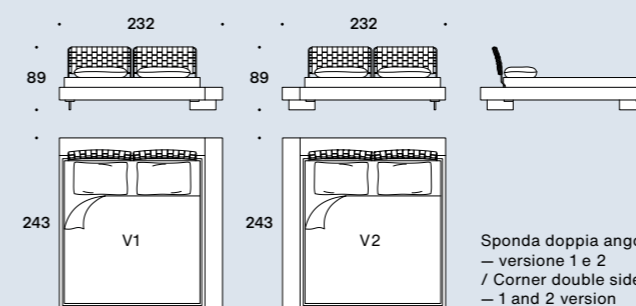

Sponda doppia angolare
– versione 1 e 2
/ Corner double sideboard
– 1 and 2 version

Testiera / Headboard



Fasce imbottite / Padded bands
Tessuto trapuntato / Quilted fabric

Fianco con testiera tessuto trapuntato / Side with quilted fabric headboard



it — Il letto Limes mantiene l'intelligente funzionalità che caratterizza l'omonimo divano adattata alla zona notte. Un'isola leggera appare sospesa su sezioni rettangolari in metacrilato trasparente di 14 cm. Limes può essere completamente riconfigurato spostando le testiere in metallo lungo tutto il perimetro del materasso. Completamente sfoderabile.

en — The Limes bed maintains the intelligent functionality that characterises the sofa line but has been adapted for a different interior area and function. The lightweight mobile island appears to be floating on its 14cm rectangular transparent legs. It can become something else by simply adjusting the position of the two metal headboards that can be placed anywhere along mattress's entire perimeter. Fully removable covers.

fr — Le lit Limes conserve l'intelligente fonctionnalité qui caractérise le canapé homonyme, adaptée à l'espace nuit. Une île légère apparaît suspendue sur des sections rectangulaires en méthacrylate transparent de 14 cm. Le lit Limes peut être complètement reconfiguré en déplaçant les têtes de lit en métal sur tout le pourtour du matelas. Entièrement déhousable.

es — La cama Limes mantiene la inteligente funcionalidad que caracteriza el sofá homónimo adaptándola a la zona noche. Una isla ligera suspendida sobre secciones rectangulares de metacrilato transparente de 14 cm. Limes se puede reconfigurar completamente desplazando los cabeceros de metal a lo largo de todo el perímetro del colchón. Completamente desenfundable.

Finitura piedi / Feet finish



1

1 Metacrilato / Methacrylate / Méthacrylate / Metacrilato

Finitura struttura pannelli testiera / Frame headboard panels finish



1

1 Cromo / Chrome / Chrome / Cromo



p. 340

Esempi posizione pannelli testiera / Examples headboard panels position

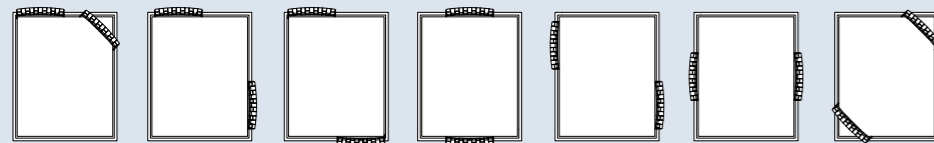

A B C D E F G

Misura rete / Size for bed base - 160x200 cm

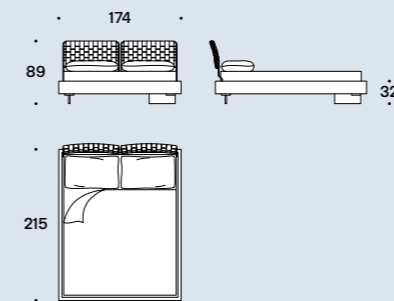

Testiera / Headboard



Fasce imbottite / Padded bands

Tessuto trapuntato / Quilted fabric

Fianco con testiera tessuto trapuntato / Side with quilted fabric headboard

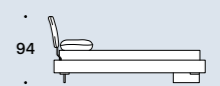

Misura rete / Size for bed base - 153x203 cm

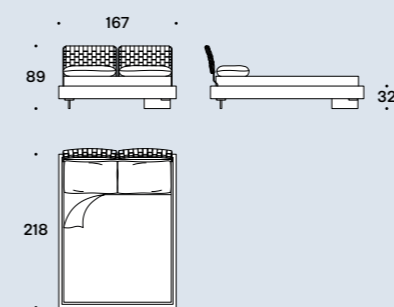

Testiera / Headboard



Fasce imbottite / Padded bands

Tessuto trapuntato / Quilted fabric

Fianco con testiera tessuto trapuntato / Side with quilted fabric headboard



Misura rete / Size for bed base - 180x200 cm

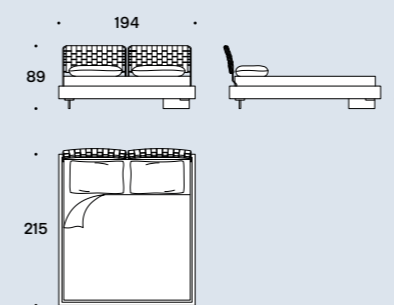

Testiera / Headboard



Fasce imbottite / Padded bands

Tessuto trapuntato / Quilted fabric

Fianco con testiera tessuto trapuntato / Side with quilted fabric headboard



Misura rete / Size for bed base - 193x203 cm

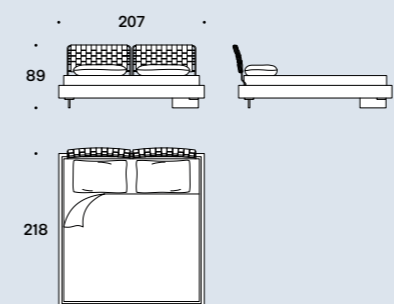

Testiera / Headboard



Fasce imbottite / Padded bands

Tessuto trapuntato / Quilted fabric

Fianco con testiera tessuto trapuntato / Side with quilted fabric headboard

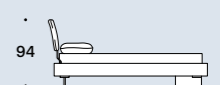

it – Limes T Large segue la stessa linea stilistica della collezione Limes ed è caratterizzato da una funzionale mensola integrata imbottita, che a seconda del posizionamento dei pannelli può aggiungere un'area extra alla testiera o alla pediera. Completamente sfoderabile.

en – Limes T Large follows the same stylistic line of the Limes collection and is characterized by a functional integrated padded shelf, which depending on the panels positioning, can add an extra area to the headboard or footboard. Fully removable covers.

fr – Limes T Large suit la même ligne stylistique que la collection Limes et se caractérise par une étagère intégrée rembourrée très fonctionnelle qui, selon la position des panneaux, peut ajouter un espace supplémentaire à la tête ou au pied de lit. Entièrement déhoussable.

es – Limes T Large sigue la misma línea estilística de la colección Limes y se caracteriza por una repisa funcional integrada y tapizada, que según la posición de los paneles puede añadir un área adicional al cabecero o al piecero. Completamente desenfundable.

Finitura piedi / Feet finish



1

1 Metacrilato / Methacrylate / Méthacrylate / Metacrilato

Finitura struttura pannelli testiera / Frame headboard panels finish



1

1 Cromo / Chrome / Cromo



p. 342

Esempi posizione pannelli testiera / Examples headboard panels position

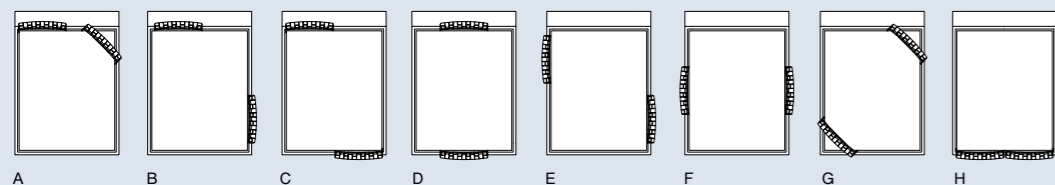

Misura rete / Size for bed base – 160x200 cm

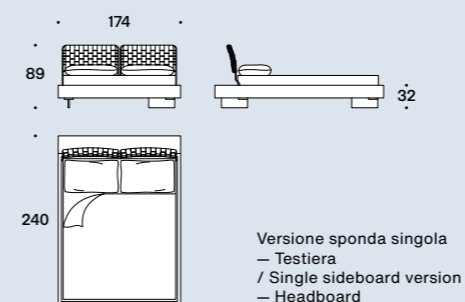

Testiera / Headboard

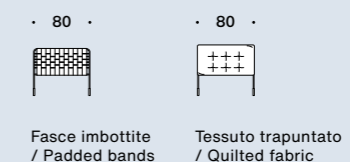

Fianco con testiera tessuto trapuntato / Side with quilted fabric headboard

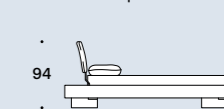

Misura rete / Size for bed base – 153x203 cm

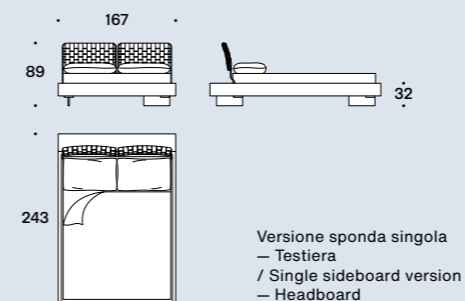

Testiera / Headboard

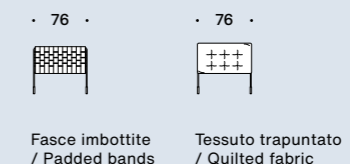

Fianco con testiera tessuto trapuntato / Side with quilted fabric headboard



Misura rete / Size for bed base – 180x200 cm

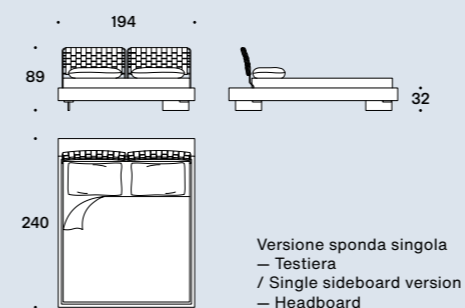

Testiera / Headboard

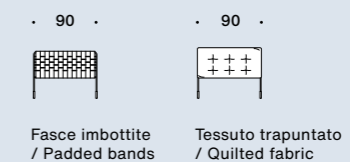

Fianco con testiera tessuto trapuntato / Side with quilted fabric headboard



Misura rete / Size for bed base – 193x203 cm

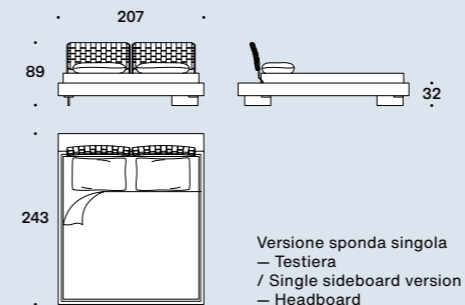

Testiera / Headboard

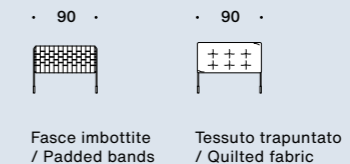

Fianco con testiera tessuto trapuntato / Side with quilted fabric headboard

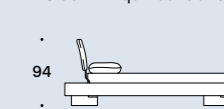

it — Avant-Après ha un'allure sobria e un tratto elegante. Rigoroso eppur leggero, assume configurazioni estremamente interessanti grazie alla particolare testiera che può essere posizionata lungo il perimetro della base. Il giroletto poggia su una base di metallo rivestita in tessuto o in pelle, sollevata da terra su piedini in metallo verniciato. Completamente sfoderabile.

en — The Avant-Après bed has a sober allure and an elegant presence. Grounded yet lightweight, it transforms into extremely interesting configurations thanks to the particular headboards that can be positioned along the bases's perimeter. The bed-frame, available for upholstery in fabric or leather, rests neatly on a metal base finished with painted metal feet. Fully removable covers.

fr — Le modèle Avant-Après possède une allure sobre et une ligne élégante. Rigoureux tout en étant léger, il prend des configurations extrêmement intéressantes grâce à la tête de lit particulière qui peut être positionnée sur tout le pourtour de la base. Le tour de lit repose sur une base en métal revêtue de tissu ou de cuir, soulevée du sol par des pieds en métal laqué. Entièrement déhoussable.

es — Avant-Après tiene un aspecto sobrio y un rasgo elegante. Riguroso y, sin embargo, ligero, asume configuraciones extremadamente interesantes gracias al particular cabecero, que puede colocarse a lo largo del perímetro de la base. El cubre somier se apoya sobre una base de metal revestida de tejido o de piel, levantada del suelo sobre pies de metal pintado. Completamente desenfundable.

Esempi posizione pannelli testiera / Examples headboard panels position

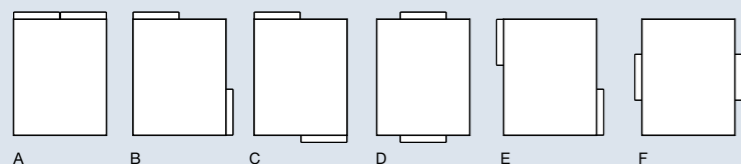

Finitura piedi / Feet finish



- 1 Grigio / Grey / Gris / Gris
- 2 Verniciato cromo satinato / Painted glazed chrome / Peint chrome satiné / Pintado cromo satinado



p. 348

Misura rete / Size for Bed base - 160x200 cm

153x203 cm

180x200 cm

193x203 cm

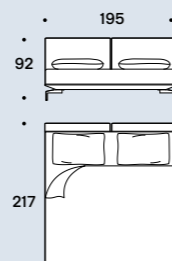
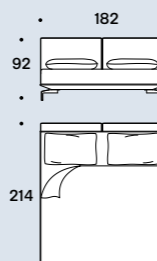
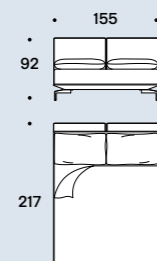
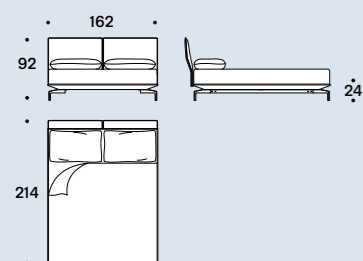

it — Bed & Breakfast è un divano che permette con un semplice movimento di ribaltare lo schienale e trasformarlo in un confortevole letto. La facilità di apertura del divano-letto è resa possibile dalla presenza di un taglio rettangolare sottostante la base e dalla particolare struttura della rete che, scorrendo orizzontalmente grazie a un meccanismo di incastro a pettine, crea un allungamento dello spazio d'appoggio. Bed & Breakfast è composto dal Divano-letto matrimoniale e la Chaise Longue-letto singolo. I maxi cuscini da appoggio possono fungere da piccola trapunta quando utilizzati nella loro interezza, una volta piegati e chiusi dai due bottoni garantiscono invece un'ottima ergonomia come schienale. Completamente sfoderabile.

en — Bed & Breakfast is a sofa which transforms into a comfortable bed simply by folding down the backrest. The sofa bed is easy to open, thanks to a rectangular hole cut into the underside of the base, and to the special structure of the boxspring, which runs horizontally on a finger-jointed mechanism to create the extra length needed. Bed and Breakfast ranges are comprised of the Sofa-double bed and the Chaise Longue-single bed. This is the result of advanced research into new-generation materials which give maximum comfort with optimum resilience. The maxi scatter cushions unfold to create a small quilt, and can then be refolded and fastened with two buttons, to offer excellent back support. Fully removable covers.

fr — Bed & Breakfast est un canapé convertible qui permet, d'un simple mouvement, de rabattre le dossier et de le transformer en un lit confortable. La facilité d'ouverture du convertible est rendue possible par la présence d'une découpe rectangulaire sous la base et par la structure particulière du sommier qui, en coulissant horizontalement, grâce à un mécanisme articulé, permet d'allonger le plan d'appui. Bed & Breakfast est composé de deux éléments : le canapé - lit double et la chaise longue - lit individuel. Les maxi-coussins peuvent se transformer en petits édredons quand il sont ouverts, tandis que repliés et fermés par les deux boutons, ils garantissent une excellente ergonomie du dossier. Entièrement déhoussable.

es — Bed & Breakfast es un sofá cama que permite voltear el respaldo y transformar el sofá en una cama confortable con un simple movimiento. La apertura del sofá es facilitada por la presencia de una hendidura rectangular debajo de la base, y por la estructura particular del somier que, deslizándose horizontalmente gracias a un mecanismo de encastrado a peine, crea un alargamiento del espacio de apoyo. Bed & Breakfast se compone de sofá-cama matrimonial y chaise longue-cama individual. Cuando se usan en su totalidad, los maxicojines de apoyo pueden usarse como un edredón; en cambio, cuando se doblan y cierran con los dos botones, garantizan una óptima ergonomía como respaldo. Completamente desenfundable.

Finitura base / Base finish



- 1 Verniciato alluminio satinato / Painted glazed aluminum / Peint aluminium satiné / Pintado aluminio satinado



p. 356

Divano-letto / Sofa-bed

Chaise longue-letto / Chaise longue-bed

Cuscino / Cushion

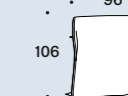
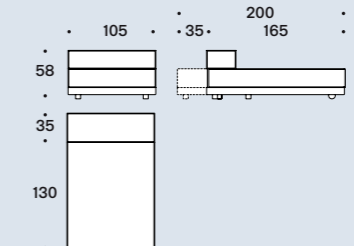
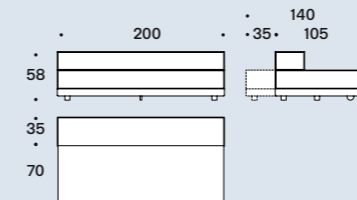

it — Il progetto trae ispirazione dalla memoria, recuperando forme semplici e iconiche che appartengono al passato. L'elemento centrale della collezione è il montante di sezione esagonale usato in edilizia che in questo contesto viene interpretato come uno snodo sul quale va ad attaccarsi perpendicolarmente il piede, anch'esso recupero stilistico che ricorda l'arredo anni '50. La base del tavolino è in trafilato metallico verniciato.

en— The project takes its inspiration from the concept of our memory, reimagining simple and iconic forms with echoes from the past. Central to the design is the upright hexagonal structure typically used in building construction that, in this particular context, is interpreted as a joint onto which the feet are attached perpendicularly. This style detail is reminiscent of 1950's furniture design. The base of the table is painted finished metallic wire drawn.

fr — Le projet puise son inspiration dans la mémoire, en récupérant des formes simples et emblématiques qui appartiennent au passé. L'élément central de la collection est un montant hexagonal utilisé dans le bâtiment. Dans ce contexte, il est interprété comme articulation sur laquelle vient s'attacher perpendiculairement le pied, lui aussi récupération stylistique évoquant les années 50. La base de la table basse est un tube de métal laqué.

es — El proyecto se inspira en la memoria, recuperando formas sencillas e icónicas que pertenecen al pasado. El elemento central de la colección es el montante de sección hexagonal propio del mundo de la construcción que en este contexto vemos interpretado como una articulación que se une a la pata de forma perpendicular, y que representa un detalle de estilo que recuerda a la decoración de los años 50. La base de la mesita es un trefilado metálico pintado.

p. 366

Tavolini tondi / Round low tables

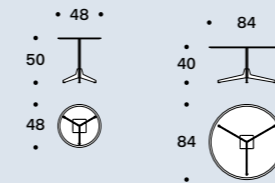

Tavolino ovale / Oval low table

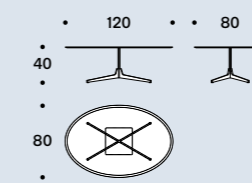

p. 370

Consolle / Console

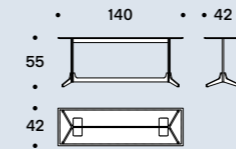

Finitura struttura / Frame finish



1 Nero opaco / Matt black / Noir mate / Negro mate

Finitura top marmo / Top marble finish

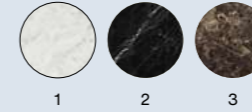
1 Bianco Carrara / White Carrara / Blanc Carrara
2 Noir antique
3 Emperador dark

Finitura top in legno / Top wood finish



1 Noce canaletto / Walnut veneer / Bois de noyer / Nogal canaletto



526



527

Low Tables & Furniture

it — Haiku è il termine giapponese che descrive un componimento poetico costituito da soli tre versi per un totale di diciassette sillabe. Il coffee table firmato Marco Zito per Saba Italia si compone appunto di tre elementi: la struttura e i due piani. L'esile architettura sospende i piani su due livelli che giocano sulla parziale sovrapposizione e su accostamenti di colore dalle nuances pastello, in un semplice e misurato rapporto di equilibrio e proporzioni. Haiku è stato pensato in una palette raffinata di colori. Struttura in tondino metallico verniciato. Piani in MDF laccato.

en — Haiku is a Japanese poem consisting of just three lines and a total of seventeen syllables. The coffee table designed by Marco Zito for Saba Italia is in fact made up of three parts: the frame and the two tops. The slim architecture suspends the tops on two levels which play with the partial overlap of colors, in a simple and well-gauged relationship of balance and proportions. Haiku was designed with a sophisticated color palette. Frame in painted metal rod. Top in lacquered MDF.

fr — Haiku est le terme japonais qui décrit un poème constitué de seulement trois vers pour un total de dix-sept syllabes. La table basse signée Marco Zito pour Saba Italia se compose justement de trois éléments : la structure et les deux plateaux. Cette architecture fine suspend les plateaux sur deux niveaux, jouant sur la superposition partielle et sur des rapprochements de couleurs aux nuances pastel, dans un rapport d'équilibre et de proportions simple et bien dosé. Haiku a été pensé dans une palette raffinée de couleurs. Structure en rond de métal laqué. Plateaux en MDF laqué.

es — Haiku es el término japonés que describe una composición poética formada solo por tres versos, hasta llegar a un total de diecisiete sílabas. La mesita de café firmada Marco Zito para Saba Italia se compone precisamente por tres elementos: la estructura y los dos tableros. La arquitectura delicada suspende los tableros en dos niveles que juegan en la superposición parcial y en las combinaciones de color de tonos pastel, en una relación simple y mesurada de equilibrio y proporciones. Haiku ha sido ideada en una refinada paleta de colores. Estructura de varilla redonda metálica pintada. Tableros de MDF lacado.



p. 372

Tavolini / Low tables

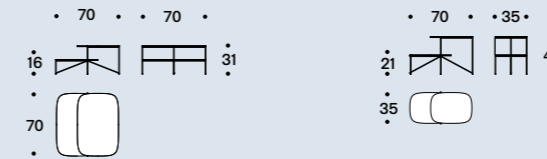
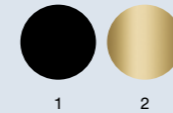
Finitura struttura
/ Frame finish

1 Nero opaco / Matt black / Noir mate
/ Negro mate
2 Ottone satinato / Satin brass
/ Laiton satiné / Latón satinado

Finitura opaca piani / Tops matt finish



1 Nero / Black / Noir / Negro

Finitura struttura
/ Frame finish

1 Nero opaco / Matt black / Noir mate
/ Negro mate

Finitura opaca piani / Tops matt finish



1 Cipria / Mud cream / Rose chair
/ Maquillage
2 Verde lichene / Moss green / Vert lichen
/ Verde liqúen
3 Grigio / Grey / Gris / Gris

it — Tavolino dalla struttura “a griglia” in tondino di ferro verniciato e saldato a quadri regolari, sofisticato e poco invasivo alla vista, decora il living room con un tocco di leggerezza e contemporaneità. Della collezione “Leyva” fa parte anche una libreria con la medesima struttura dal design lineare ed essenziale. La sua silhouette snella e minimale evoca un’idea di grande leggerezza, rendendola inseribile in qualsiasi ambiente, sia posizionata a parete che appoggiata a terra. Perfetta in soggiorni contemporanei, trova la sua collocazione ideale anche in ambienti di stile industriale ma può essere affiancata, come nota inattesa, anche ad arredi classici. Mensole mobili e basamento, per la versione a terra, sono in lamiera verniciata.

en — The Leyva table is made of painted iron rod welded into a grille of uniform squares. Sophisticated and unintrusive, Leyva decorates the living room with a light, contemporary touch. The Leyva collection also includes a latticework bookcase with the same design, a clean-cut and essential silhouette. Its willowy minimal contours conjure up an airy lightness. Whether it is wall-mounted or free-standing, it will easily blend into any setting. Perfect for modern settings and a seamless solution for industrial surrounds, it could also bestow an unexpected twist on more classical décor. Moveable shelves and the base, for floor version, are in coated sheet metal.

fr — Table basse structurée à partir d'une armature en acier soudée et vernie. Sophistiquée et peu envahissante, elle décore le living avec une touche de légèreté et de modernité. La collection Leyva comprend également une bibliothèque de même design, linéaire et épuré. Sa silhouette simple et minimaliste évoque une idée de légèreté extrême, et la rend compatible avec toutes les ambiances. Elle s'installe librement soit en aplomb d'un mur soit en appui au sol. Parfaitement à sa place dans les séjours contemporains, elle est tout aussi idéale dans les ambiances de style industriel ou peut constituer un élément inattendu dans un décor plus classique. Les étagères du meuble et la base, pour la bibliothèque autoportante, sont en tôle vernis.

es — Mesa de centro con estructura a rejilla, en varilla de hierro pintado y soldado formando cuadrados regulares, sofisticado y algo impactante a la vista, decora la sala de estar con un toque de levedad y contemporaneidad. La colección Leyva también incluye una librería con el mismo diseño, lineal y esencial. Su silueta esbelta y minimalista evoca una idea de gran ligereza y se adapta a cualquier ambiente, ya sea contra una pared o apoyada en el suelo. Ideal para salas de estar contemporáneas y también para ambientes de estilo industrial, puede aportar una nota inesperada en combinación con muebles clásicos. Los repisas móviles y la base, para la librería de suelo, son de chapa pintada.

p. 376

Tavolini / Low tables

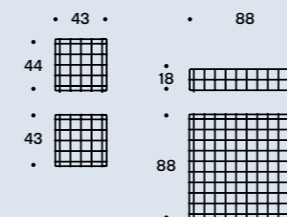

p. 376

Libreria alta / High bookcase

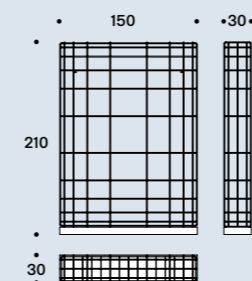

Libreria pensile / Wall bookcase

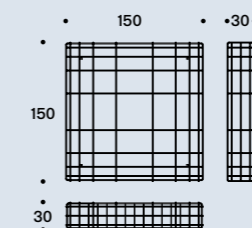
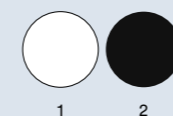
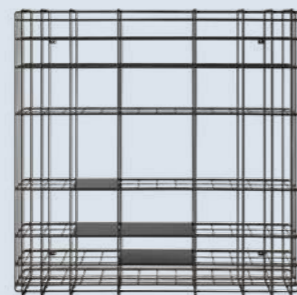
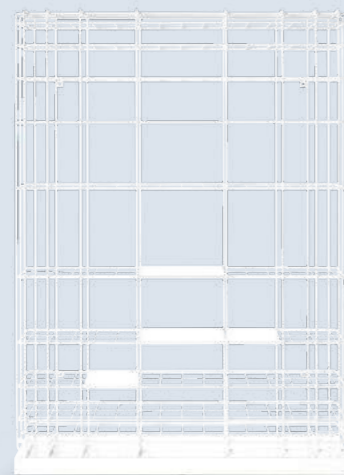
Finitura lucida struttura
/ Frame glossy finish1 Bianco / White / Blanc / Blanco
2 Nero / Black / Noir / Negro

it — Eleganti come gioielli, i tavolini da caffè Ring si ispirano ai tagli delle pietre preziose quando vengono montate sugli anelli. La scelta delle finiture mira a sottolineare questa similitudine: le strutture in metallo sono disponibili in diverse varianti a cui corrispondono altrettante forme. Su queste basi i piani in vetro, trasparenti e lievemente colorati, vengono letteralmente montati.

en — Elegant like jewellery, the Ring coffee tables are inspired by raw cuts of precious stones prior to being mounted into rings. The choice of materials is aimed to emphasise this inspiration behind the collection. The metal base structures are available in several variants each of which corresponds to a geometric form. Like in jewellery design, the glass tops in transparent or light colours are literally set onto the base structures.

fr — Aussi élégantes que des bijoux, les tables basses Ring s'inspirent des découpes des pierres précieuses que l'on monte sur les bagues. Le choix des finitions vise à souligner cette similitude : les structures en métal sont disponibles en plusieurs variantes auxquelles correspondent autant de formes. Les plateaux en verre, transparents et légèrement colorés, sont littéralement sertis sur ces piètements.

es — Elegantes como joyas, las mesas de café Ring se inspiran en los cortes de las piedras preciosas cuando se montan en los anillos. La elección de los acabados busca destacar esta similitud: las estructuras de metal están disponibles en variantes que se corresponden con otras tantas formas. Sobre estas bases literalmente se engarzan las tapas de vidrio, transparentes y levemente coloreadas.

p. 382

Tondo / Round

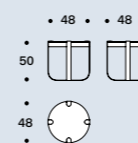

Quadrato / Square

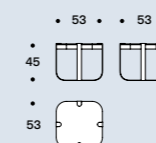

Ottagonale / Octagonal

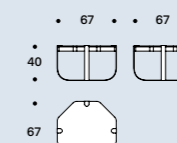

Ovale / Oval

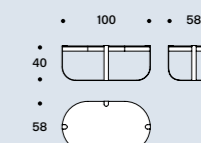

Combinazione finitura struttura e top in vetro
/ Frame and glass top finish combo

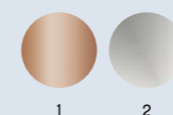

Tondo / Round / Ronde / Redondo
1 Rame / Copper / Cuivre / Cobre
2 Fumè / Fumè / Fumè / Ahumado



Quadrato / Square / Carré / Cuadrado
3 Ottone satinato / Satin brass / Laiton satiné / Latón satinado
4 Trasparente / Transparent / Transparent / Transparente

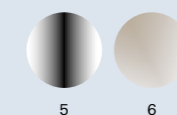

Ottagonale / Octagonal / Octagonal / Octagonal
5 Black nichel / Black nickel / Nickel noir / Níquel negro
6 Bronzo / Bronze / Bronze / Bronce



Ovale / Oval / Ovale / Oval
7 Cromo / Chrome / Chrome / Cromo
8 Acqua marina / Sea water / Eau de mer / Agua de mar



it — Metallo, legno, corda: materiali semplici che reinventano oggetti di uso comune. Una collezione di pouf e tavolini in tondino di metallo e corda nautica intrecciata, si mescolano come in una tavolozza di pittore. La citazione al noto brano Ziggy Stardust di David Bowie non è casuale e rimanda a un'idea di ironia e stravolgimento della tipologia del complemento nella zona relax. Le silhouettes a botte e a clessidra s'incontrano per comporre isole che si espandono: intrecci e volumi si perfezionano negli abbinamenti delle tonalità mixate delle corde, indicando una nuova idea di complemento con una possibilità illimitata di personalizzazione dello spazio. La corda intrecciata a due colori è una combinazione esclusiva Saba.

en — Metal, wood, rope: simple materials which reinvent commonly used objects. A collection of poufs and coffee tables made in metal rods and woven nautical cords, mixed together like the paints on an artist's palette. The reference to David Bowie's iconic Ziggy Stardust is no accident and relates to the irony in the idea of revolutionising the type of accessory furniture in the area for relaxing. The barrel and hourglass silhouettes come together to make up islands which expand: interweaving and volumes are enhanced in the coordination of the mixed colours of the cord, pointing to a new idea of furnishing accessory with endless possibilities of personalising the space. The two-tone plaited rope is an exclusive Saba combination.

fr — Métal, bois, corde, des matériaux simples pour réinventer les objets d'usage courant. Une collection de poufs et de tables basses en tiges métalliques, pour se fondre comme sur la palette d'un peintre. Les silhouettes en tonneau et en sablier se rencontrent pour composer des îlots en expansion: les tressages et les volumes se perfectionnent dans les rapprochements des teintes mélangées des cordages, en proposant un nouveau concept du mobilier d'appoint pour une personnalisation de l'espace. Le cordage tressé bicolore est une combinaison exclusive signée Saba.

es — Metal, madera, cuerda, materiales simples que reinventan objetos de uso común. Una colección de taburetes bajos y mesas de centro en varillas redondas de metal y cuerda náutica trenzada, se mezclan como en una paleta de pintor. Las siluetas tipo barril y clessidra se reúnen para componer islas expansibles: asociaciones y volúmenes que se perfeccionan en las combinaciones de tonalidades mezcladas de los cabos, indicando una nueva idea de complemento con una posibilidad ilimitada de personalización del espacio. La cuerda trenzada de dos colores es una combinación exclusiva de Saba.



p. 386

Tavolini botte e clessidra
/ Low tables - barrel and hourglass

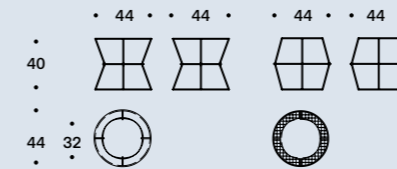

Combinazione finitura struttura + top e cime - Tavolini
/ Frame + top and ropes finish combo - Low tables



Pouf botte e clessidra
/ Pouf - barrel and hourglass

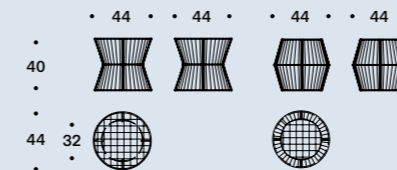

Finitura struttura / Frame finish - Pouf



1 Grigio ardesia / Slate grey / Gris ardoise / Gris pizarra

Finitura cime / Ropes finish - Pouf

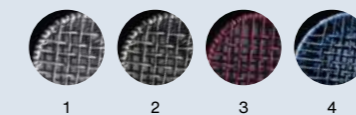

1 Grigio / Grey / Gris / Gris
2 Canapa / Hemp / Chanvre / Cáñamo
3 Bordeaux Arancio / Bordeaux Orange / Bordeaux Orange / Burdeos Naranja
4 Azzurro / Azure / Azur / Azul

Più Table

design Giuseppe Viganò

it — Tavolino leggero e stilisticamente definito, dal design netto e deciso ma dall'anima elegante e delicata. Base in metallo e piano in MDF. È disponibile con finitura laccata opaca.

en — A light, crisp and stylish table with a strong, clean design and an elegant, dainty spirit. Metal base and MDF top. Available in a matt lacquered finish.

fr — Table basse légère au style bien défini. Design net et franc au service d'une âme élégante et délicate. Base en métal et plateau en MDF. Disponible en finition laquée.

es — Mesa de centro ligera y con personalidad estilística definida, de diseño neto y determinado pero con alma elegante y delicada. Base de metal y tapa de MDF. Está disponible con acabado lacado mate.



p. 390

Tavolini / Low tables

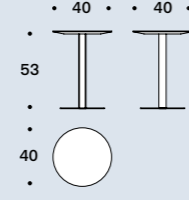
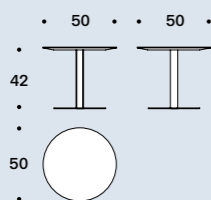
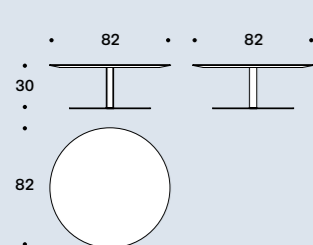

Finitura opaca piani e struttura
/ Matt table top and frame finish

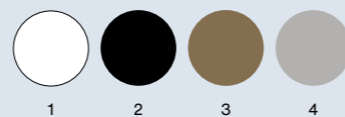

1 Bianco / White / Blanc / Blanco
2 Nero / Black / Noir / Negro
3 Bronzo / Bronze / Bronze / Bronce
4 Argento / Silver / Argent / Plata

536

Shade

design Marco Zito

it — In giapponese Shade indica il paravento. Saba reinterpreta l'oggetto in chiave contemporanea destinandogli un posto nel living. Shade è un filtro, una quinta, un piccolo sistema che si compone costruendo gli spazi, decorando, separando, ritagliando angoli di privacy. Le due misure permettono di creare ambienti fortemente caratterizzanti, scegliendo tra diversi tessuti che si accostano armoniosamente agli imbottiti e agli accessori. La forma morbida priva di angoli è la cifra riconducibile al poetico segno progettuale del designer Marco Zito. Disponibile anche con inserto fonoassorbente.

en — Shade, as in the Japanese meaning of "divider", has been restyled in a contemporary way and found a place in the living area. Shade is a filter, a divider, a compact system created for constructing spaces: decorating, separating, reserving private and intimate corners. The two sizes and the different textiles for upholstery allow for a high degree of customization in terms of space and product. The lyrical design trait of Marco Zito is evident in the lack of corners, an organic and soft shape. Also available with soundproof insert.

fr — En japonais Shade indique le paravent. Saba réinterprète l'objet sous un jour contemporain en lui donnant une place dans le séjour. Shade est un filtre, un panneau, un petit système qui se compose en construisant les espaces, en décorant, en séparant, en créant des coins intimes. Les deux dimensions permettent de créer des environnements distincts à travers la sélection des tissus qui se coordonnent harmonieusement avec les meubles rembourrés et les accessoires. La forme douce sans angles vifs renvoie immédiatement la poésie qui caractérise les créations du designer Marco Zito. Disponible également avec panneau insonorisé.

es — En japonés, el término Shade indica el biombo. Saba reinterpreta este objeto en clave contemporánea y le asigna un lugar en la sala de estar. Shade es un filtro, un bastidor, un pequeño sistema que se compone construyendo los espacios, decorando, separando y delimitando rincones de privacidad. Las dos medidas permiten crear ambientes de gran personalidad, eligiendo entre distintos tejidos que se combinan armoniosamente con los acolchados y los complementos. La forma suave sin esquinas es la cifra inspiradora de la poética peculiaridad de diseño de Marco Zito. Disponible también con panel insonorizado.



p. 392

Paraventi / Dividers

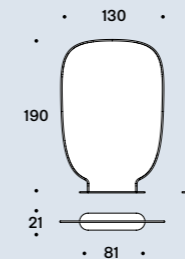
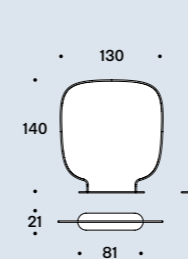

Finitura opaca struttura
/ Frame matt finish



1 Nero / Black / Noir / Negro

537

Low Tables & Furniture

it — La collezione New York outdoor amplia la propria proposta con una linea di sedute dall'intreccio esclusivo interamente realizzato a mano. New York Soleil è il risultato di un'accurata ricerca sui materiali al fine di preservare l'unicità del progetto originale. Corde nautiche intrecciate di diverse nuance ricamano con leggerezza la struttura in tondino di metallo verniciato con trattamento per esterni. L'ergonomica seduta è rivestita in tessuto tecnico che non assorbe l'acqua, consentendo una rapida asciugatura, inoltre l'alta performance al test martindale garantisce resistenza all'abrasione e contemporaneamente un'igienica traspirazione. Nel 2020 la collezione amplia la propria proposta con un nuovo elemento: la Poltrona Lounge. New York Soleil interpreta l'arte di vivere l'esterno con poetica leggerezza di stile e suggestioni cromatiche, offrendo la possibilità di scegliere tra nuance diverse, mélange e tinta unita. La collezione comprende il divano, la poltroncina, il pouf, la sedia con e senza braccioli e lo sgabello. Completamente sfoderabile.

en — The New York outdoor collection expands with a line of exclusive woven seating made entirely by hand. New York Soleil is the product of careful research into materials and the desire to maintain the unique original design. Woven nautical cords of different colors softly cover the painted metal rod structure. The ergonomic cushion is covered in a quick-drying, non-absorbent technical fabric, and its superior performance in the Martindale test guarantees abrasion resistance as well as hygienic breathability. In 2020 the collection adds a new element: the Lounge Armchair. The New York Soleil embodies outdoor living with a casual style and colorful charm. It is available in different blends and solid colors. The collection includes a sofa, an armchair, a pouf, a chair with or without armrests and a stool. Fully removable covers.

fr — La collection New York outdoor élargit sa proposition avec une ligne d'assises dont l'entrelacement exclusif est entièrement réalisé à la main. New York Soleil est le résultat d'une recherche approfondie sur les matériaux afin de préserver le caractère unique du projet original. Des cordages nautiques tressés dans plusieurs nuances forment une légère broderie sur la structure en ronds de métal laqués avec traitement adéquat pour résister à l'extérieur. L'assise ergonomique est revêtue d'un tissu technique qui n'absorbe pas l'eau permettant ainsi un séchage rapide. De plus, la haute performance au test Martindale garantit la résistance à l'abrasion ainsi qu'une respiration hygiénique. En 2020, la collection s'agrandit en proposant un nouvel élément : le Fauteuil Lounge. New York Soleil interprète l'art de vivre l'extérieur avec une légèreté de style et des suggestions chromatiques à l'enseigne de la poésie, en offrant la possibilité de choisir entre nuances différentes, mélangées ou unies. La collection comprend un canapé, un petit fauteuil, un pouf, une chaise avec ou sans accoudoirs et un tabouret. Entièrement déhoussable.

es — La colección New York para exteriores amplía su propuesta con una línea de asientos trenzados exclusivos realizados totalmente a mano. New York Soleil es fruto de un estudio minucioso de los materiales con el fin de preservar la unicidad del proyecto original. Cuerdas náutica trenzada de distintos matices bordean con ligereza la estructura realizada con varillas de metal pintado con tratamiento para exteriores. Tiene un asiento ergonómico revestido de un tejido técnico que no absorbe el agua, permitiendo un secado rápido; además, las altas prestaciones en el test martindale garantizan resistencia a la abrasión y al mismo tiempo una transpiración higiénica. En 2020 la colección amplía su propuesta con un nuevo elemento: el Sillón Lounge. New York Soleil interpreta el arte de vivir al aire libre con una poética ligereza de estilo y sugerencias cromáticas, ofreciendo la posibilidad de elegir entre colores, mélange y liso. La colección incluye el sofá, el sillón, el pouf, la silla con y sin brazos y el taburete. Totalmente desfundable.

p. 396

Divano / Sofa

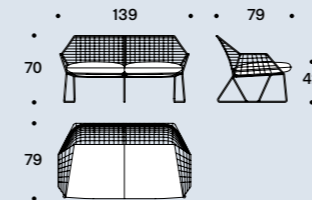

Poltrona / Armchair

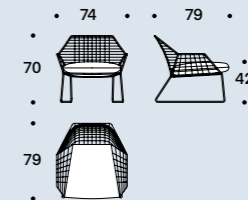

Pouf

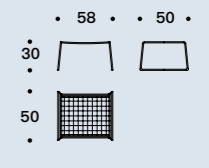

Sedia con e senza braccioli / Chair with and without armrests

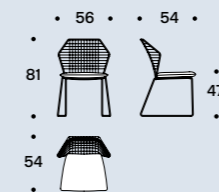
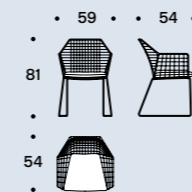

Sgabello alto e basso / High and low stool

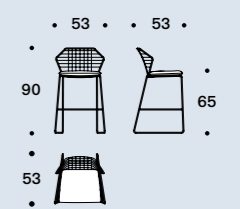
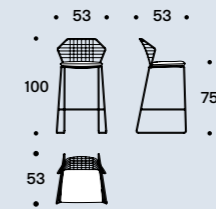

Poltrona lounge / Lounge armchair

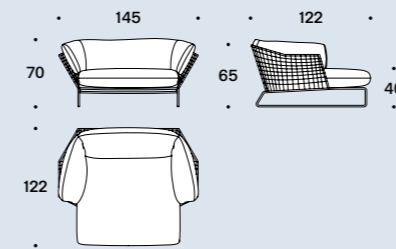

Finitura struttura / Frame finish
Divano, poltrona, poltrona lounge e pouf
/ Sofa, armchair, lounge armchair and pouf

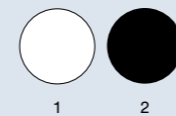

- 1 Outdoor - Bianco / White / Blanc / Blanco
- 2 Outdoor - Nero / Black / Noir / Negro

Finitura struttura / Frame finish
Sedie e sgabelli / Chairs and stools

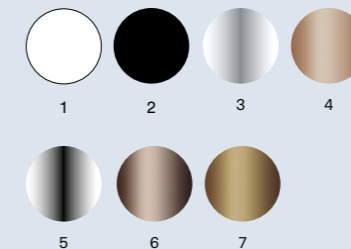

- 1 Outdoor - Bianco / White / Blanc / Blanco
- 2 Outdoor - Nero / Black / Noir / Negro
- 3 Cromo / Chrome / Chrome / Cromo
- 4 Rame lucido / Glossy copper / Cuivre brillant / Cobre brillante
- 5 Black nichel / Black nickel / Nickel noir / Niquel negro
- 6 Bronze copper matt
- 7 Bronze gold matt

Finitura cime / Ropes finish



- 1 Nero / Black / Noir / Negro
- 2 Canapa / Hemp / Chanvre / Cáñamo
- 3 Grigio / Grey / Gris / Gris
- 5 Azzurro / Azure / Azur / Azul
- 6 Arancio / Orange / Orange / Naranja



it — Garden è un tavolo outdoor leggero e stilisticamente definito, dal design netto e deciso ma dall'anima elegante. Il top in HPL e la base in metallo sono verniciati con trattamento adatto agli ambienti esterni. Il tavolo, disponibile in tre dimensioni, è completamente smontabile e facilmente trasportabile. Abbinato alla nuova collezione New York Soleil ricrea l'oasi di comfort ideale per esterni.

en — Garden is a stylish outdoor table, with a distinct design and elegant look. The HPL top and metal base are painted to suit outdoor environments. The table, available in three sizes, can be completely dismantled and easily transported. Matched with the new New York Soleil collection, it creates an oasis of comfort, ideal for outdoor use.

fr — Garden est une table basse pour extérieur légère et au style bien défini, au design épuré et décidé mais à l'âme élégante. Dessus en HPL et piètement en métal laqués avec traitement adéquat pour résister à l'extérieur. La table, disponible en trois dimensions, est entièrement démontable et facile à transporter. Associée à la nouvelle collection New York Soleil, elle recrée une oasis de confort idéale pour extérieur.

es — Garden es una mesa para exteriores, ligera y estilisticamente definida, de diseño neto y decidido pero de alma elegante. Encimera de HPL y base de metal pintadas con tratamiento apto para ambientes exteriores. La mesa está disponible en tres medidas y es completamente desmontable y fácilmente transportable. Combinada con la nueva colección New York Soleil, recrea el oasis de confort ideal para ambientes exteriores.



p. 410

Tavolini / Low tables

Tavoli / Tables

Finitura struttura & top / Frame & top finish

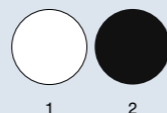

1 Bianco / White / Blanc / Blanco
2 Nero / Black / Noir / Negro

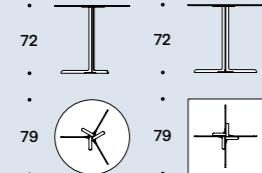
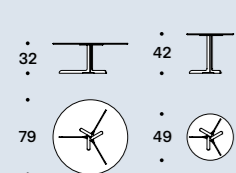

it — Il magico intreccio di colori delle corde nautiche dei paraventi Shade of Venice, si ispira alle isole veneziane, grazie a una campionatura di tinte tipiche dei luoghi. Nascono così quattro collezioni: Murano, Burano, Giudecca e Sant'Erasmus. Dalla pietra bianca della Giudecca, ai colori delle verdure coltivate nell'isola orto di Venezia Sant'Erasmus come il carciofo. I colori del vetro azzurro e verde acqua giocano nella trama e nell'ordito del paravento ispirato a Murano, mentre le sfumature accese e a contrasto della serie Burano citano le case a tinte forti dell'isola, arancio e blu. Un gioco di pieni e vuoti cela o lascia trasparire gli ambienti con leggerezza, per infinite composizioni in interno o esterno.

en — The Shade of Venice dividers, inspired by the Venetian islands and their local glow, are created with a magical colorful weave of nautical cords. From the white stone of Giudecca to the colors of the vegetables that grow in the garden patches of Venice's Sant'Erasmus, four variations were born: Murano, Burano, Giudecca and Sant'Erasmus. The light blue and green colors of Murano play in the threads of the divider's weave, whilst the bright tonalities and contrasts of the Burano design reflect the colorful houses of the island in orange and blue. The design plays with positive and negative space, creating a peek-a-boo effect subtly revealing the surroundings beyond. The Shade of Venice dividers allow for great flexibility and infinite styling possibilities, both indoor and outdoor.

fr — L'entrelacement magique de couleurs des cordes nautiques des paravents Shade of Venice s'inspire des îles vénitienes, auxquelles ils ont emprunté un échantillon de nuances caractéristiques. C'est ainsi que sont nées quatre collections : Murano, Burano, Giudecca et Sant'Erasmus. De la pierre blanche de l'île de la Giudecca aux couleurs des légumes tels que l'artichaut cultivés sur l'île potager de Venise, Sant'Erasmus. Les couleurs du verre bleu ciel et vert d'eau jouent dans la trame et la chaîne du paravent inspiré de l'île de Murano, tandis que les nuances vives et contrastées de la série Burano évoquent les maisons aux couleurs fortes de l'île, l'orange et le bleu. Un jeu de pleins et de vides qui tantôt dissimule les espaces tantôt les laisse entrevoir avec légèreté, pour une multitude de compositions en intérieur ou en extérieur.

es — El mágico entramado de los colores de las cuerdas náuticas del biombo Shade of Venice se inspira en las islas venecianas gracias a una muestra de tintas típicas del lugar. Nacen de este modo cuatro colecciones: Murano, Burano, Giudecca y Sant'Erasmus. De la piedra blanca de la Giudecca, a los colores de las verduras cultivadas en la isla huerto de Venecia, Sant'Erasmus, como la alcachofa. Los colores del vidrio azul y verde agua juegan en la trama y en el urdimbre del biombo inspirado en Murano, mientras que los tonos vivos y en contraste de la serie Burano recuerdan las casas de colores brillantes de la isla, en naranja y azul. Un juego de llenos y vacíos oculta o deja que se transparenten los ambientes con ligereza, para crear infinitas composiciones tanto en el interior y como en el exterior.

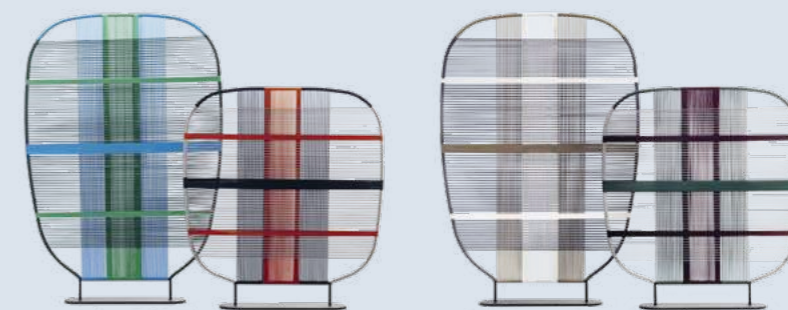

p. 412

Paraventi / Dividers

Finitura opaca struttura / Frame matt finish

Finiture cime / Ropes finish

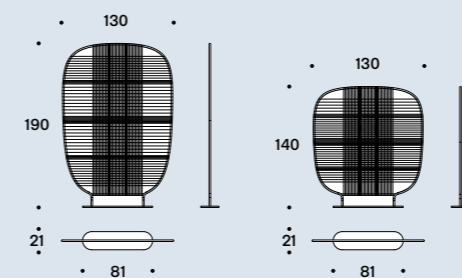

1 Nero / Black / Noir / Negro

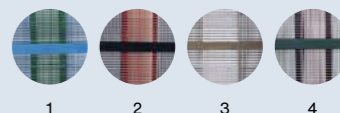

1 Murano
2 Burano
3 Giudecca
4 Sant'Erasmus

it — Metallo, legno, corda: materiali semplici che reinventano oggetti di uso comune. Una collezione di pouf e tavolini in tondino di metallo e corda nautica intrecciata, si mescolano come in una tavolozza di pittore. La citazione al noto brano Ziggy Stardust di David Bowie non è casuale e rimanda a un'idea di ironia e stravolgimento della tipologia del complemento nella zona relax. Le silhouettes a botte e a clessidra s'incontrano per comporre isole che si espandono: intrecci e volumi si perfezionano negli abbinamenti delle tonalità mixate delle corde, indicando una nuova idea di complemento con una possibilità illimitata di personalizzazione dello spazio. La corda intrecciata a due colori è una combinazione esclusiva Saba.

en — Metal, wood, rope: simple materials which reinvent commonly used objects. A collection of poufs and coffee tables made in metal rods and woven nautical cords, mixed together like the paints on an artist's palette. The reference to David Bowie's iconic Ziggy Stardust is no accident and relates to the irony in the idea of revolutionising the type of accessory furniture in the area for relaxing. The barrel and hourglass silhouettes come together to make up islands which expand: interweaving and volumes are enhanced in the coordination of the mixed colours of the cord, pointing to a new idea of furnishing accessory with endless possibilities of personalising the space. The two-tone plaited rope is an exclusive Saba combination.

fr — Métal, bois, corde, des matériaux simples pour réinventer les objets d'usage courant. Une collection de poufs et de tables basses en tiges métalliques, pour se fondre comme sur la palette d'un peintre. Les silhouettes en tonneau et en sablier se rencontrent pour composer des îlots en expansion: les tressages et les volumes se perfectionnent dans les rapprochements des teintes mélangées des cordages, en proposant un nouveau concept du mobilier d'appoint pour une personnalisation de l'espace. Le cordage tressé bicolore est une combinaison exclusive signée Saba.

es — Metal, madera, cuerda, materiales simples que reinventan objetos de uso común. Una colección de taburetes bajos y mesas de centro en varillas redondas de metal y cuerda náutica trenzada, se mezclan como en una paleta de pintor. Las siluetas tipo barril y clesidra se reúnen para componer islas expansibles: asociaciones y volúmenes que se perfeccionan en las combinaciones de tonalidades mezcladas de los cabos, indicando una nueva idea de complemento con una posibilidad ilimitada de personalización del espacio. La cuerda trenzada de dos colores es una combinación exclusiva de Saba.



p. 416

Tavolini botte e clessidra / Low tables - barrel and hourglass

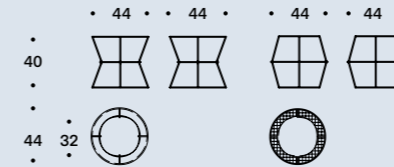

Combinazione finitura struttura + top e cime - Tavolini / Frame + top and ropes finish combo - Low tables



Pouf botte e clessidra / Pouf - barrel and hourglass

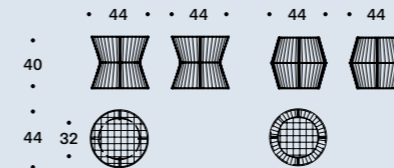

Finitura struttura / Frame finish - Pouf



Finitura cime / Ropes finish - Pouf



Geo Pouf Outdoor

design Paolo Grasselli

it — Gli iconici Geo pouf di Saba escono all'aperto. Geo è un elemento di arredo versatile che può ora essere utilizzato anche in ambienti outdoor grazie alla tela termo saldata che rende l'imbottitura impermeabile. Nella versione outdoor la struttura in metallo non è disponibile. Completamente sfoderabile.

en — Saba's iconic Geo pouf moves outdoor. The versatile element that is the Geo pouf can now be used in outdoor environments thanks to the thermo-treated upholstery that allows for the seating to be water resistant. In the outdoor version the metal structure is not available. Fully removable covers.

fr — Les emblématiques poufs Geo de Saba sortent au grand air. Geo est un élément de mobilier polyvalent qui peut désormais être utilisé également à l'extérieur grâce à sa toile thermo-soudée qui rend le rembourrage imperméable. Dans la version outdoor, la structure en métal n'est pas disponible. Entièrement déhoussable.

es — Los emblemáticos Geo puf de Saba salen al exterior. Geo es un elemento de decoración versátil que ahora se puede utilizar también en ambientes al aire libre gracias a la tela termoadherida que hace que el acolchado sea impermeable. La estructura de metal no está disponible en la versión para exteriores. Completamente desenfundable.



p. 420

Pouf

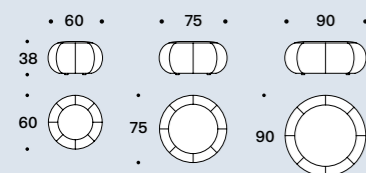

544

New York Outdoor

design Sergio Bicego

Saba

it — Il divano New York Outdoor è il risultato di un'accurata ricerca sui materiali al fine di preservare l'unicità del progetto originale. Si caratterizza per la struttura in tondino di metallo verniciato con trattamento adatto agli ambienti esterni. L'ergonomica cuscineria è rivestita in tessuto tecnico che non assorbe l'acqua, consentendo una rapida asciugatura, inoltre l'alta performance al test martindale garantisce resistenza all'abrasione e contemporaneamente un'igienica traspirazione. L'imbottitura dei cuscini è in poliuretano drenante rivestita da una fodera bianca impermeabile. New York Outdoor interpreta l'arte di vivere l'esterno con poetica leggerezza di stile e suggestioni cromatiche, offrendo la possibilità di scegliere tra diverse nuance, mélange e tinta unita. Abbinato alla poltroncina di serie ricrea l'oasi di comfort ideale per esterni. Completamente sfoderabile.

en — New York Sofa outdoor is the result of careful research into materials so as to preserve the uniqueness of the original design. It features a painted tubular metal frame specifically treated for outdoor use. The ergonomic cushion is covered in a quick-drying, non-absorbent technical fabric, and its great performance in the Martindale test guarantees abrasion resistance as well as hygienic breathability. The cushions are filled with quick-draining polyurethane, with a waterproof white cover. New York outdoor interprets the art of outdoor living with poetically light style and colorful charm, offering a choice of different tones, blends and solid colors. Combined with the standard armchair, it creates the ideal oasis of comfort outdoors. Fully removable covers.

fr — Le canapé New York outdoor est le résultat d'une recherche approfondie sur les matériaux afin de préserver le caractère unique du projet original. Il se caractérise par une coque en rond de métal laqué avec traitement adéquat pour résister à l'extérieur. Les coussins ergonomiques sont revêtus d'un tissu technique qui n'absorbe pas l'eau en permettant un séchage rapide. De plus, la haute performance au test Martindale garantit la résistance à l'abrasion ainsi qu'une respiration hygiénique. Le rembourrage des coussins est en polyuréthane drainant, revêtu d'une doublure blanche imperméable. New York outdoor interprète l'art de vivre l'extérieur avec une légèreté de style et des suggestions chromatiques à l'enseigne de la poésie, en offrant la possibilité de choisir entre différentes nuances, mélangées et unies. Associé au fauteuil de la collection, il crée une oasis de confort idéale, pour l'extérieur. Entièrement déhoussable.

es — Los sofás New York outdoor para exteriores es el resultado de una esmerada investigación aplicada a los materiales cuyo objetivo es preservar la unicidad del proyecto original. Se caracteriza por la estructura en varilla de metal pintado, con tratamiento apropiado para exteriores. Los cojines ergonómicos están tapizados con tejido técnico que no absorbe el agua y facilita el secado. Además de los excelentes resultados a la prueba de Martindale garantiza resistencia a la abrasión y, a su vez, una transpiración higiénica. El relleno de los cojines es de poliuretano de óptimo drenaje revestido por una funda blanca impermeable. New York outdoor interpreta el arte de vivir al aire libre con una poética ligereza de estilo y sugerencias cromáticas, ofreciendo la posibilidad de elegir entre diferentes colores, mélange y liso. Combinado con la butaca de serie, recrea el oasis de confort ideal para ambientes exteriores. Completamente desenfundable.



p. 424

Divano / Sofa

Poltrona / Armchair

Finitura struttura / Frame finish

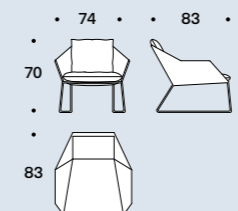
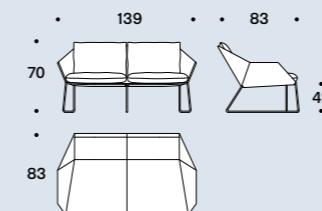

1

1 Bianco / White / Blanc / Blanco

545

Outdoor

it — Grace, la collezione outdoor firmata Paolo Grasselli, arreda lo spazio con evocativa leggerezza. Segni grafici si fanno materia e cerchi in metallo disegnano trame nello spazio in una geometria dai legami solo apparentemente casuali. Anelli in metallo di diverse misure danno vita a una famiglia di sedute e complementi dove l'aspetto decorativo si fonde con quello strutturale. In un gioco di pieni e vuoti, colore e trasparenza, si delineano le forme di una poltroncina, di un divano a due posti, di un tavolino e di un pouf. Forme in divenire dove l'idea di seduta si frammenta e si ricompone al tempo stesso senza un perimetro ben definito, ma in un etereo confine tra lo spazio e la materia, tra l'oggetto e l'ambiente. In base alla disposizione degli anelli e alla posizione dei cuscini si crea un'armonia di segni che danno vita a oggetti dal forte impatto decorativo e dalla sorprendente comodità. Prodotto non sfoderabile.

en — The Grace outdoor collection by Paolo Grasselli is an irresistibly dainty decorative range. Geometric patterns materialize and metal lines trace circles through the air in an artistic élan that is much more deliberate than what it seems at first glance. Metal rings of differing sizes breathe life into a seating and accessories collection where practicality and beauty become one. Empty circles clasp cushioned spheres in a cluster of colored and transparent bubbles, settling down magnificently into a tub chair, a loveseat, a low table and a pouf. New forms arise where the concept of a chair has been torn apart and made whole again; yet the distinction between space, matter, and object has become blurred. Depending on the arrangement of the rings and the positioning of the cushions, different harmonious patterns can be created - the end result will always be strikingly decorative and surprisingly comfortable. Non removable covers.

fr — Grace, la collection signée par Paolo Grasselli, organise l'espace avec une légèreté évocatrice. Les signes graphiques se font matières et les cercles de métal trament dans l'espace au fil d'une géométrie dont les liens ne semblent qu'aléatoires. Des anneaux de métal de différentes proportions donnent vie à une famille de sièges et d'accessoires dont l'aspect décoratif se fonde dans la structure. Par un jeu de pleins et de déliés, de couleur et de transparence, un siège prend forme, et la ligne se décline en canapé deux places, table basse et poufs. Des formes en devenir: l'idée de siège se fragmente et se recompose simultanément sans périmètre prédéfini, mais dans des limites éthérées entre l'espace et la matière, entre l'objet et son environnement. A partir de la disposition des anneaux et du jeu des coussins se crée une harmonie des signes qui donne vie à ces objets à fort impact décoratif, mais d'une surprenante adaptabilité. Produit non déhoussable.

es — Grace, la colección para exteriores firmada por Paolo Grasselli, viste el espacio con una ligereza evocadora. Signos gráficos se hacen materia y círculos de metal dibujan tramas en el espacio en una geometría con vínculos sólo aparentemente casuales. Anillos de metal de diferentes medidas dan vida a una familia de asientos y complementos donde el aspecto decorativo se une al estructural. En un juego de llenos y vacíos, color y transparencia, se delinean las formas de un sillón, de un sofá de dos plazas, de una mesa de centro y de un puf. Formas cambiantes que fragmentan y al mismo tiempo recomponen la idea de un asiento sin un perímetro bien definido, en un etéreo confín entre el espacio y la materia, entre el objeto y el ambiente. En base a la disposición de los anillos y a la posición de los cojines se crea una armonía de signos que dan vida a objetos de fuerte impacto decorativo y sorprendente comodidad. Producto no desenfundable.

p. 428

Divano / Sofa

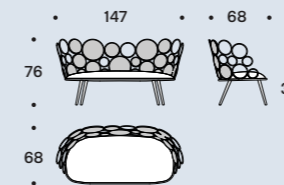

Poltrona / Armchair

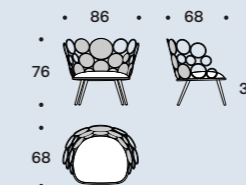

Pouf

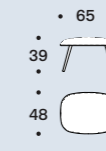

p. 428

Tavolino imbottito / Low padded table

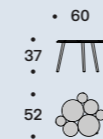

Tavolino / Low table

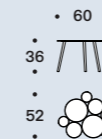

Finitura struttura / Frame finish

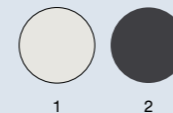

- 1 Grigio chiaro / Light grey
/ Gris clair / Gris claro
- 2 Grigio ardesia / Slate grey
Gris ardoise / Gris pizarra



Project managers
Alessandra Santi
Amelia Pegorin

Art direction
Studio MILO

Photography
Beppe Brancato
ContrattiCompany
Claudio Rocci

Graphic Design
Designwork

Text translation
Isabel Migliore
PSG Translations
Studio Intra

Made and printed in
Italy, July 2020
by Grafiche Antiga



Thanks to:

altreforme
Atelier Vetra
Barbara Schweizer Edizioni
Bloc Studios
Bosa
cc-tapis
Contardi Lighting
Davide Groppi
Desalto
Eligo
Federica Biasi
Fiandre Surfaces
FROM LIGHTING
Il Fanale
JCP
LATOxLATO
Manerba
Manfredi Style
Martinelli Luce
MBAE Studio
MMairo
MM Lampadari
Masiero
Mason Editions
Mingardo
Miniforms
Nahoor
Panzeri
Residenza Location
Salvatori
SEM Milano
Serena Confalonieri
SERVOMUTO
Simona Cardinetti
Society Limonta
Studio Sonia Pedrazzini
Tato Italia
TIPIQA
Tubes Radiatori
Vito Nesta
ZAVA luce

A special thanks to Camp Design Gallery and all the artists who have contributed to this issue.

Jon Thomas sculptures
pp: 108, 110, 111, 114-115, 117, 138, 140-141, 147, 148-149, 153, 172, 175, 226, 364

Camp Design Gallery
Paolo Gonzato Baracche, 2016
pp: 022-023, 142-143, 145, 147, 148-149, 307

Studio La Cube sculpture
Trigo, Perro, Roca R1 - R3, 2018
p: 101

Matteo Pellegrino White vase, 2017
pp: 096, 102-103

Ginevra Taccola Crateria collection, 2018
pp: 06, 142-143, 145, 146

APalazzo Gallery
Paolo Gonzato and Alessandro Mendini vase Tutankhamon, 2013
pp: 221, 256

Manfredy Style Gallery
Ahryun Lee Tasty collection porcelain vases
pp: 108, 112-113, 250, 348, 350-351

Merve Kahraman Minos Lamp White
pp: 314, 316-317, 318, 319

Alessandro Teoldi courtesy of Suprainfinit Gallery
pp: 010, 012-013, 018-019, 062-063, 064, 182, 234

Antonio Marras
pp: 015, 016-017, 075, 078-079, 080-081, 130-131, 204-205, 308

antigallery
pp: 030, 032-033, 034-035, 037, 038-039, 040-041, 118, 120-121, 156-157, 202, 204-205

Saba Italia

35018 S. Martino di Lupari
Padova / Italy
via dell'Industria, 17
T +39 049 946 2227
F +39 049 946 2219
infosaba@sabaitalia.it
www.sabaitalia.it

The background is a rich, textured brown color with a fine, repeating pattern. Overlaid on this are several white, thin-lined geometric shapes. These shapes are primarily quarter-circles and semi-circles, some of which are partially cut off by the edges of the frame. The lines are clean and minimalist, creating a modern, architectural feel.

sabaitalia.it