



C O N T R O L U C E

---

I T A L I A N H O M E F A S H I O N

BOOK 02

preview



# CONTROLUCE

ITALIAN HOME FASHION

Eleganza, design e forte personalità per “vestire” tutta la casa: CONTROLUCE risponde al desiderio di un prodotto di arredo sofisticato e prezioso, curatissimo in ogni dettaglio, come un capo di alta moda. Una collezione dall’alto contenuto sartoriale, ispirata nelle finiture e nei dettagli al mondo della moda, da sempre testimone indiscusso dello stile italiano nel mondo. Linee moderne lasciano trasparire un fascino senza tempo, ispirato al lusso di qualità. CONTROLUCE arreda con raffinatezza e gusto ambienti classici e moderni, osservando e interpretando con sapienza e originalità le tendenze dell’abitare contemporaneo.

~

Elegance, design and a strong personality to “dress” the entire house: CONTROLUCE satisfies the desire for a sophisticated and precious furnishing product, careful attention is given to every detail, just like an haute couture garment. An exquisitely tailored collection, with finishes and details inspired by the world of fashion, always the undisputed testimony of Italian style around the world. Modern lines reveal a timeless charm, inspired by high quality luxury. CONTROLUCE furnishes classic and modern interiors with elegance and taste, observing and interpreting the trends of contemporary living with skill and originality.

designed and dressed by  
Alessandro Castello ~ Maria Antonietta Lagravinese

## INDICE/INDEX BOOK 02

### DIVANI/SOFAS

|         |              |
|---------|--------------|
| Stewart | 8-11, 15     |
| Celine  | 24-27, 30-31 |
| Tracy   | 32-34        |

### POLTRONE/ARMCHAIRS

|                  |              |
|------------------|--------------|
| Vivien           | 8-9, 14      |
| Vivien alta/high | 6-7          |
| Grace            | 16-17, 58-59 |
| Stewart          | 12-13        |
| Celine           | 24-25, 29    |
| Tracy            | 32-33, 38-39 |

### LETTI/BEDS

|              |       |
|--------------|-------|
| Vivien Royal | 56-61 |
|--------------|-------|

### PANCHE/BENCHES

|              |       |
|--------------|-------|
| Vivien Royal | 58-59 |
|--------------|-------|

### TAVOLO DA PRANZO/DINING TABLE

|         |              |
|---------|--------------|
| Humprey | 18-21        |
| Judy    | 40-43, 50-55 |

### SEDIA/CHAIR

|          |              |
|----------|--------------|
| Samantha | 18-21, 50-55 |
| Ingrid   | 40-41, 44-45 |

## INDICE/INDEX BOOK 02

### MOBILI/FURNITURE

|                                     |                            |
|-------------------------------------|----------------------------|
| Alexander mobilebar/winecabinet     | 18-19, 22-27, 40-41, 46-47 |
| Alexander credenza/cupboard         | 40-41, 48-49               |
| Jasmine comodino/bedside table      | 56-59, 62-63               |
| Jasmine cassetiera/chest of drawers | 64-65                      |

### CONSOLLE/CONSOLES

|           |                  |
|-----------|------------------|
| Elizabeth | 24-25, 28, 66-67 |
|-----------|------------------|

### TAVOLINI/SMALL TABLES

|           |                                     |
|-----------|-------------------------------------|
| Richard   | 8-9, 14-15                          |
| Elizabeth | 24-25, 27                           |
| Judy      | 6-7, 16-17, 24-25, 29, 32-35, 37-39 |

### POUFS

|       |       |
|-------|-------|
| Tracy | 36-37 |
|-------|-------|

### SPECCHI/MIRRORS

|        |           |
|--------|-----------|
| Joan   | 40-41, 48 |
| Lauren | 32-33     |

### LAMPADE/LAMPS

|         |                                 |
|---------|---------------------------------|
| Natalie | 7, 28, 40-41, 48, 56-59, 63, 66 |
|---------|---------------------------------|

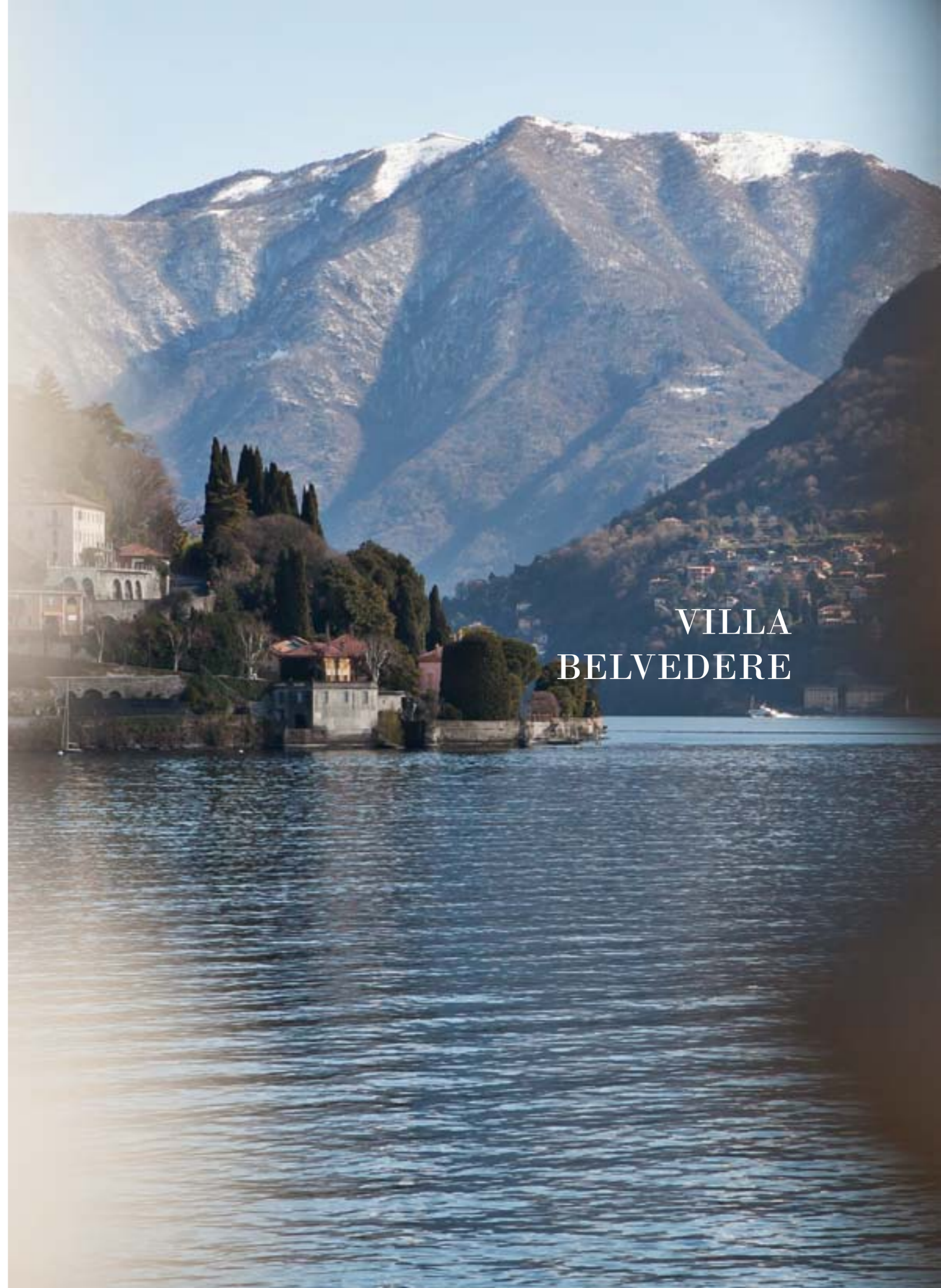
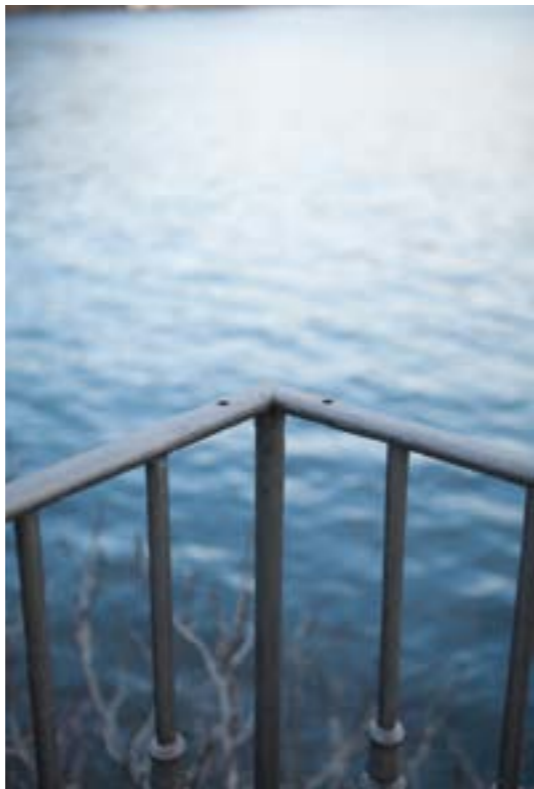
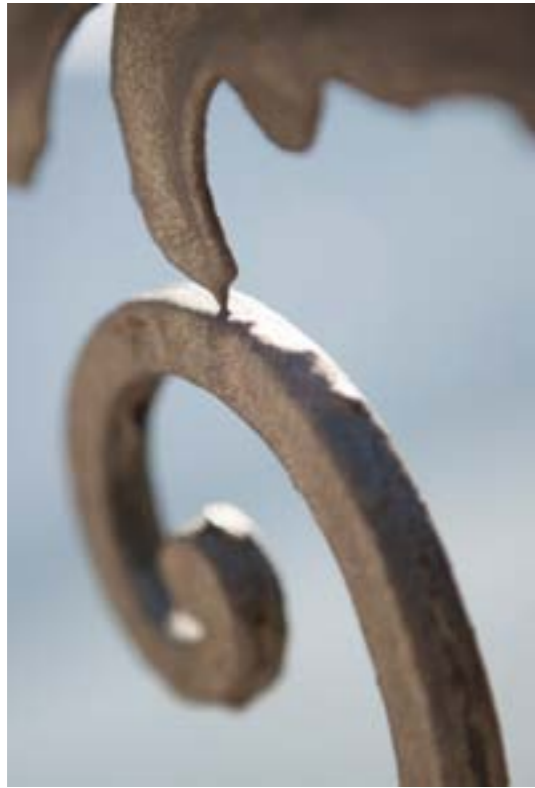

VILLA  
BELVEDERE



Poltrona alta/high armchair **Vivien**  
Tavolino/small table **Judy 53**  
Lampada piantana/floor lamp **Natalie**





Divano/sofa **Stewart**  
Poltrona/armchair **Vivien**  
Tavolini/small tables **Richard 120x80, Richard 90**



Divano/sofa **Stewart**



Poltrona/armchair **Stewart**





Poltrona/armchair **Vivien**  
Divano/Sofa **Stewart**  
Tavolino/small table **Richard 120x80**



Poltrona/armchair **Grace**  
Tavolino/small table **Judy 53**



Tavolo da pranzo/dining table **Humphrey**  
Sedia con cameo/chair with cameo **Samantha**  
Mobile bar/wine cabinet **Alexander**



Tavolo da pranzo/dining table **Humprey**  
Sedia con cameo/chair with cameo **Samantha**



mobile bar/wine cabinet **Alexander**



Divano/sofa **Celine**

Cuscino con logo Lux/pillow with logo Lux **77**

Poltrona/armchair **Celine**

Tavolino/small table **Elizabeth 120**

Consolle bassa/low console **Elizabeth**

Tavolino/small table **Judy 53**

Mobile bar/wine cabinet **Alexander**



Divano/sofa **Celine**  
Cuscino con cameo/pillow with cameo **77**  
Tavolino/small table **Elizabeth 120**  
Mobile bar/wine cabinet **Alexander**



Poltrona/armchair **Celine**  
 Tavolino/small table **Judy 53**  
 Consolle bassa/low console **Elizabeth**  
 Lampada da tavolo/table lamp **Natalie**







Divano/sofa **Celine**  
Cuscino con cameo/pillow with cameo **41**



Divano/sofa **Tracy**

Cuscino con cameo/pillow with cameo **77**

Poltrona small/small armchair **Tracy**

Tavolini/small tables **Judy 53, Judy 90**

Specchio/Mirror **Lauren**



Divano/sofa **Tracy**  
Tavolino/small table **Judy 53**



Pouf **Tracy**  
Tavolino/small table **Judy 53**





Poltrona small/small armchair **Tracy**  
Tavolino/small table **Judy 53**





Tavolo da pranzo/ dining table **Judy**  
Sedia con cameo/ chair with cameo **Ingrid**  
Mobile bar/wine cabinet **Alexander**  
Credenza/cupboard **Alexander**  
Specchio/Mirror **Joan**  
Lampade applique/applique lamps **Natalie**



Tavolo da pranzo/dining table **Judy**



Sedia con cameo/chair with cameo **Ingrid**





Mobile bar/wine cabinet **Alexander**



Credenza/cupboard **Alexander**  
Specchio/mirror **Joan**  
Lampade applique/applique lamps **Natalie**

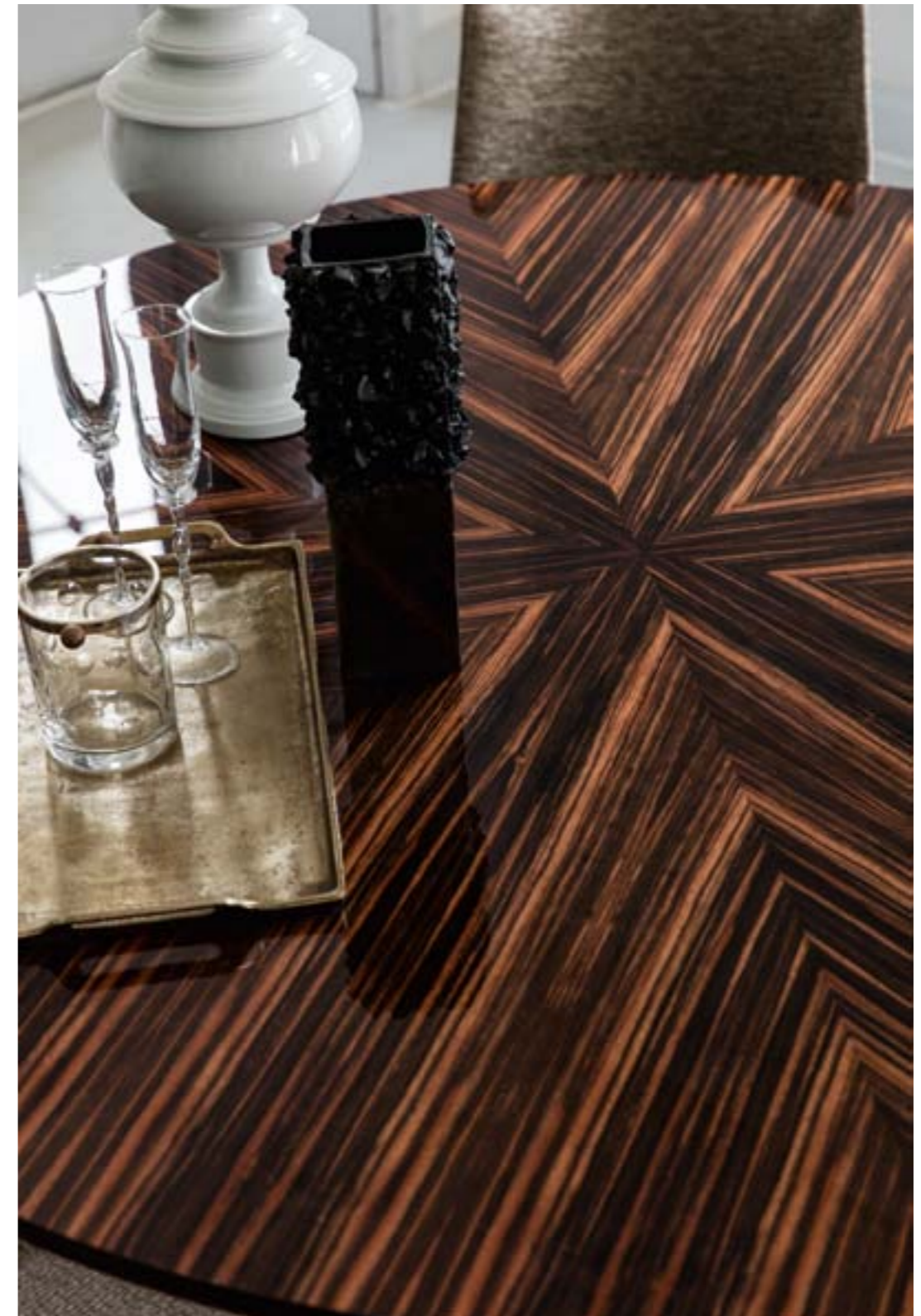

Tavolo da pranzo/dining table **Judy**  
Sedia con cameo/chair with cameo **Samantha**



Tavolo da pranzo e lazy susan/dining table and lazy susan **Judy**  
Sedia con cameo/chair with cameo **Samantha**



Tavolo da pranzo e lazy susan/dining table and lazy susan **Judy**  
Sedia con cameo/chair with cameo **Samantha**

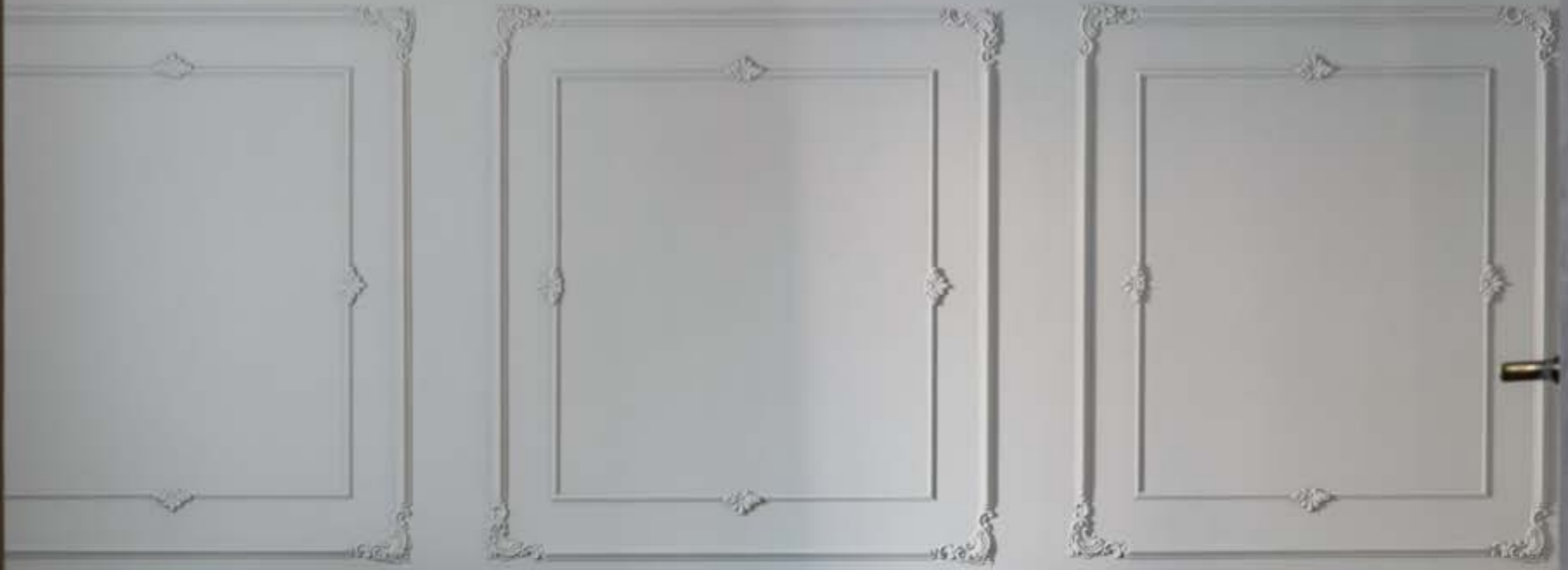

Letto/bed **Vivien Royal**  
Comodini/bedside tables **Jasmine**  
Lampade da tavolo/table lamps **Natalie**



Letto/bed **Vivien Royal**  
Panca/bench **Vivien Royal**  
Comodini/bedside tables **Jasmine**  
Poltrona/armchair **Grace**  
Lampade/lamps **Natalie**



Letto/bed Vivien Royal





Comodino/bedside table **Jasmine**  
Lampada da tavolo/table lamp **Natalie**





Cassettiera/chest of drawers **Jasmine**



Consolle bassa/low console **Elizabet**  
Lampada da tavolo/table lamp **Natalie**



**RIEPILOGO  
SUMMARY**

## RIEPILOGO/SUMMARY

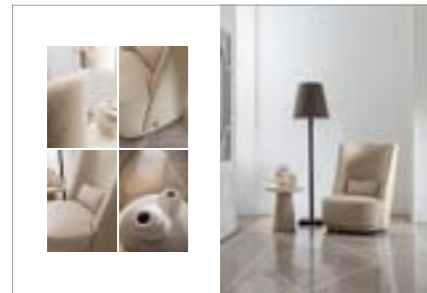

6

7

**VIVIEN** poltrona alta/high armchair  
 • 01VIVC2 (2VIVPH-2VIVPGS) • 9G9 Nabuk daino/9G9S1  
 Bamboo Daino stampa intreccio/woven print, Cat. L  
**JUDY 53** tavolino/small table Ø53  
 • 2JUDTD53L • Top Cream • Base 9G9 Nabuk daino, Cat. I  
**NATALIE** Lampada piantana/floor lamp  
 • PAPIA

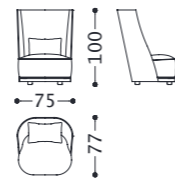

18

19

**HUMPHREY** tavolo da pranzo/dining table 220x110  
 • 1HUMTPR20 • Top Ebano/ebony • struttura/structure  
 bronze  
**SAMANTHA** sedia con cameo/chair with cameo  
 • 2SAMSECM-2SAMSECMCB • 9G9 Nabuk Daino -919 Raji  
 daino, Cat. M • struttura/structure wengè  
**ALEXANDER** mobile bar/wine cabinet  
 • 03ALEC13 (IATLBMBLTOP-2ALEBMB) • Top Mist • Base  
 919 Raji daino, Cat. M

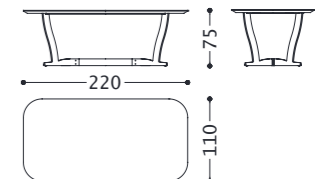

8

9

**STEWART** divano/sofa  
 • 02STWC4 (2STWD2SPSX-2STWD2SPDX) • 9J1 Silk pearl,  
 Cat. I-logo trapuntato/quilted logo  
**VIVIEN** poltrona/armchair  
 • 1VIVP • 8235 Visus panna, Cat. 8  
**RICHARD 120X80** tavolino/small table 120x80  
 • 1RICTAVR • marmo/marble Daino reale, Cat. X2  
 • struttura/structure bronze  
**RICHARD 90** tavolino/small table 90x90  
 • 1RICTQ90 • marmo/marble Daino reale, Cat. X2  
 • struttura/structure bronze

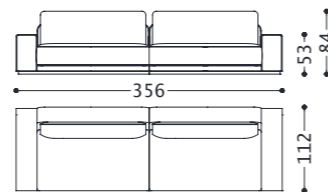

24

25

**CELINE** divano/sofa • 1CELEFAP • 8215 Platus lino, Cat. 8  
 77 cuscino con logo Lux/pillow with logo Lux • 177CQRIL •  
 919 Raji daino, Cat. M  
**CELINE** poltrona/armchair • 1CELESA • 6071 Teller ghiaccio,  
 Cat. 6  
**ELIZABETH 120** tavolino/small table 120x120 • 1ELITQ120  
 • marmo/marble Onice rosso, Cat. X4 • struttura/structure  
 Noce canaletto/Canaletto walnut  
**ELIZABETH** consolle bassa/low console • 1ELICL56 • marmo/  
 marble Onice rosso, Cat. X4 • struttura/structure Noce  
 canaletto/Canaletto walnut  
**JUDY 53** tavolino/small table Ø53 • 2JUDTD53 • Top noce  
 Canaletto/Canaletto walnut • Base 918 Raji avorio, Cat. M  
**ALEXANDER** mobile bar/wine cabinet • 03ALEC13  
 (IATLBMBLTOP-2ALEBMB) • Top Rust • Base 917 Raji  
 bruciato, Cat. M

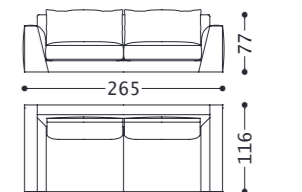

10

13

**STEWART** divano/sofa  
 • 2STWD3MSP • 9J1 Silk pearl, Cat. I-logo trapuntato/quilted  
 logo  
**STEWART** poltrona/armchair  
 • 2STWP • 9J1 Silk pearl, Cat. I-logo trapuntato/quilted logo

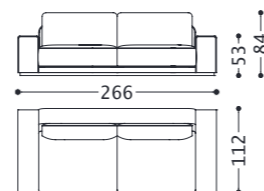

30

31

**CELINE** divano/sofa  
 • 2CELEFAP • 9G11 Nabuk bosco, Cat. I  
 41 cuscino con cameo/pillow with cameo  
 • 2C41CQR1 • 9G11 Nabuk bosco, Cat. I

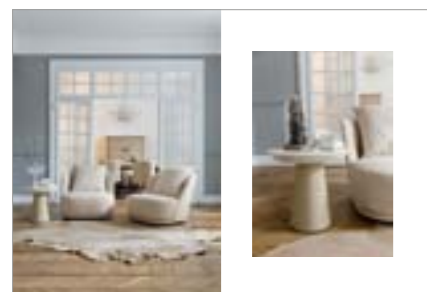

16

17

**GRACE** poltrona/armchair  
 • 1GRAP • 8235 Visus panna, Cat. 8  
**JUDY 53** tavolino/small table Ø53  
 • 2JUDTD53 • Top noce Canaletto/Canaletto walnut • Base  
 918 Raji avorio, Cat. M  
**JUDY 53** tavolino/small table Ø53  
 • 2JUDTD53L • Top Cream • Base 9G9 Nabuk daino, Cat. I

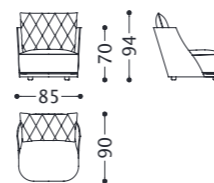

32

33

**TRACY** divano/sofa • 2TRCD3M • 8A4 Capital corda, Cat. G  
 77 cuscino con cameo/pillow with cameo • 177CQR1 • 6086  
 Teller felce, Cat. 6  
**TRACY** poltrona small/small armchair • 2TRCPS • 8A4 Capital  
 corda, Cat. G -logo trapuntato/quilted logo  
**TRACY** pouf • 1TRCPOUFF • 6086 Teller felce, Cat. 6  
**JUDY 53** tavolino/small table Ø53 • 2JUDTD53 • Top Noce  
 canaletto/Canaletto walnut • Base 918 Raji avorio, Cat. M  
**JUDY 90** tavolino/small table Ø90 • 2JUDTD90 • Top Noce  
 canaletto/Canaletto walnut • Base 918 Raji avorio, Cat. M  
**LAUREN** specchio/mirror • LAUSPEE

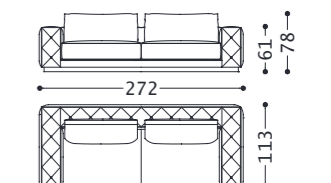

## RIEPILOGO/SUMMARY



40

41

**JUDY** tavolo da pranzo/dining table 280x100  
 • 2JUDTAVP • Top Ebano/ebony • Base 9I9 Raji daino, Cat. M - logo trapuntato/quilted logo  
**INGRID** sedia con cameo/chair with cameo  
 • 2INGSECM-2INSECMCB • 8A4 Capital corda, Cat. G • struttura/structure wengè  
**ALEXANDER** credenza/cupboard  
 • 03ALEC16 (1ALQCREDTOP-2ALECRED) • Top Ebano/ebony • Base 9I9 Raji daino, Cat. M  
**ALEXANDER** mobile bar/wine cabinet  
 • 03ALEC13 (1ATLBMBLTOP-2ALEBMB) • Top Rust • Base 9I7 Raji bruciato, Cat. M  
**JOAN** specchio/mirror • JOASPEO  
**NATALIE** applique • PAAPP

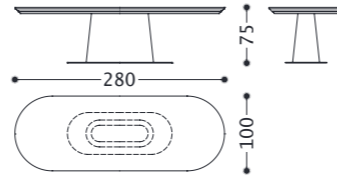

50

53

**JUDY** tavolo da pranzo/dining table Ø180  
 • 2JUDTPR1 • Top Ebano/ebony • Base 9I10 Raji mud, Cat. M- logo trapuntato/quilted logo  
**JUDY** lazy susan  
 • 2JUDLS • bronze-ebano/ebony  
**SAMANTHA** sedia con cameo/chair with cameo  
 • 1SAMSECM • A001 Yoda tortora - COO1 Heliodor tortora, Cat. 12 • struttura/structure wengè

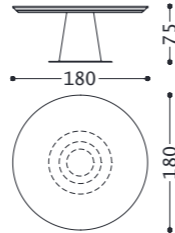

58

59

**VIVIEN LETTO ROYAL** letto/bed • 2VIRLA180 • 9G9 Nubuk daino, 9G9S1 Bamboo daino stampa intreccio/woven print, Cat. L  
**VIVIEN LETTO ROYAL** panca/bench • 2VIRPC180 • 9G9 Nubuk daino, Cat. I  
**VIVIEN LETTO** cuscini e coordinati letto/pillows and bedding set • 1VILCL180 • 8153 Zincy greige, Cat. 8 • 1VILCQ60P • 8153 Zincy greige, Cat. 8 • 1VILCQ45 • 7011 Satin nocciola, Cat. 7, 8230 Villa latte, Cat. 8 • 1VILCOPLA180 • 8230 Villa latte, Cat. 8  
**VIVIEN** cuscini e coordinati letto/pillows and bedding set • 2VIVPGB • 9G9S1 Bamboo daino stampa intreccio/woven print, Cat. L  
**JASMINE** comodino/bedside table • 2JASCOMOD • struttura/structure cream • frontali/front parts 9G9S1 Bamboo daino stampa intreccio/woven print, Cat. L  
**GRACE** poltrona/armchair • 1GRAP • 8235 Visus panna, Cat. 8  
**NATALIE** Lampade/lamps • PALTA • PAPIA

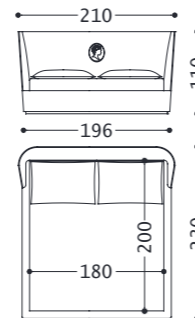

64

66

**JASMINE** cassettiera/chest of drawers  
 • 2JASDRW • struttura/structure cream • frontali/front parts 9G9S1 Bamboo daino stampa intreccio/woven print, Cat. L  
**GRACE** poltrona/armchair  
 • 1GRAP • 8235 Visus panna, Cat. 8  
**ELIZABETH** consolle bassa/low console  
 • 1ELICL56 • marmo/marble Onice rosso, Cat. X4 • struttura/structure Noce canaletto/canaletto walnut  
**NATALIE** lampada da tavolo/table lamp  
 • PALTA

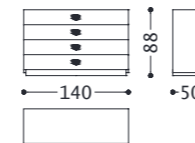

FINITURE  
FINISHES



MARMO/MARBLE

---

Magic Brown • Cat. X1



Arabesque purple • Cat. X1



Daino Reale • Cat. X2



Calacatta White • Cat. X4



Cream Calacatta • Cat. X4



Verde Issorie • Cat. X4



Marquina black • Cat. X2



Emperador Brown • Cat. X3

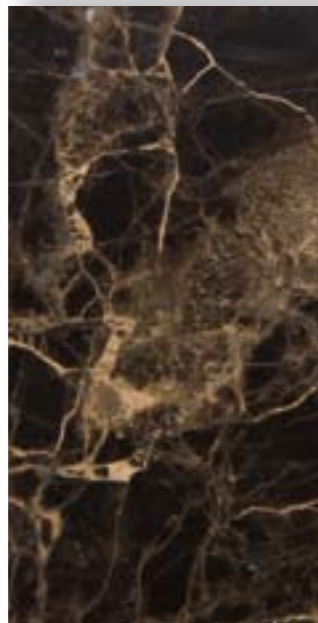

Onice Rosso • Cat. X4



METALLO/METAL

---

Brunito / Browned



Bronzo / Bronze



Rame / Copper



LEGNO/WOOD

---

Noce Canaletto / Walnut



Rovere Scuro / Dark Oak



Ebano / Ebony



LACCATI/LACQUERED

---

Cream

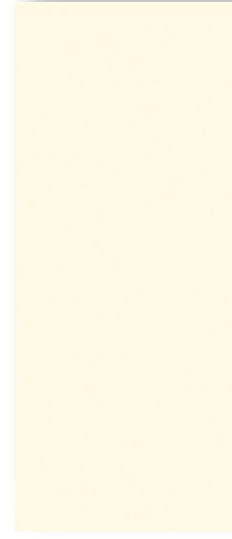

Mist

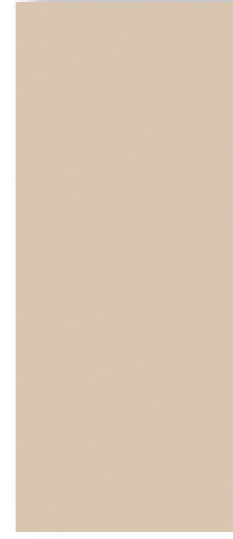

Rust



Dark brown





HISTOIRE  
DU  
PAPIER PEINT  
EN  
FRANCE



DISEGNI TECNICI  
TECHNICAL DRAWINGS

divano/sofa **Vivien**

elementi/elements



Cod. Tessuto/fabric: 1/01  
Cod. Pelle/leather: 2/02

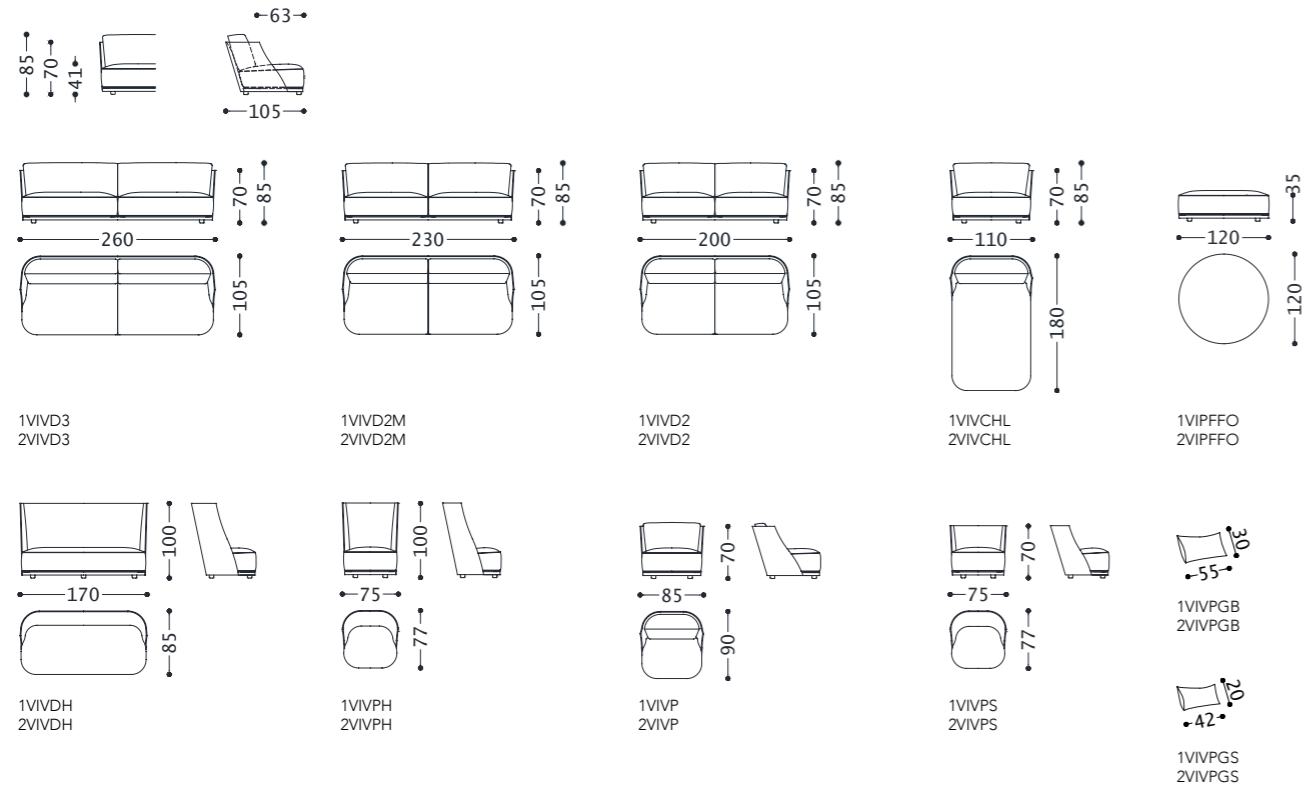

divano/sofa **Vivien**

composizioni/composition

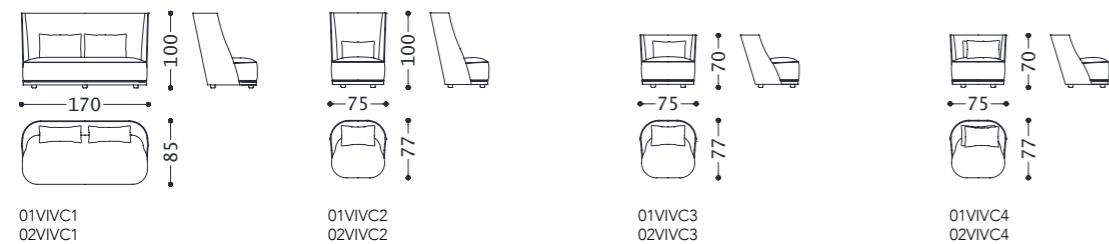

divano/sofa **Grace**

elementi/elements



Cod. Tessuto/fabric: 1  
Cod. Pelle/leather: 2

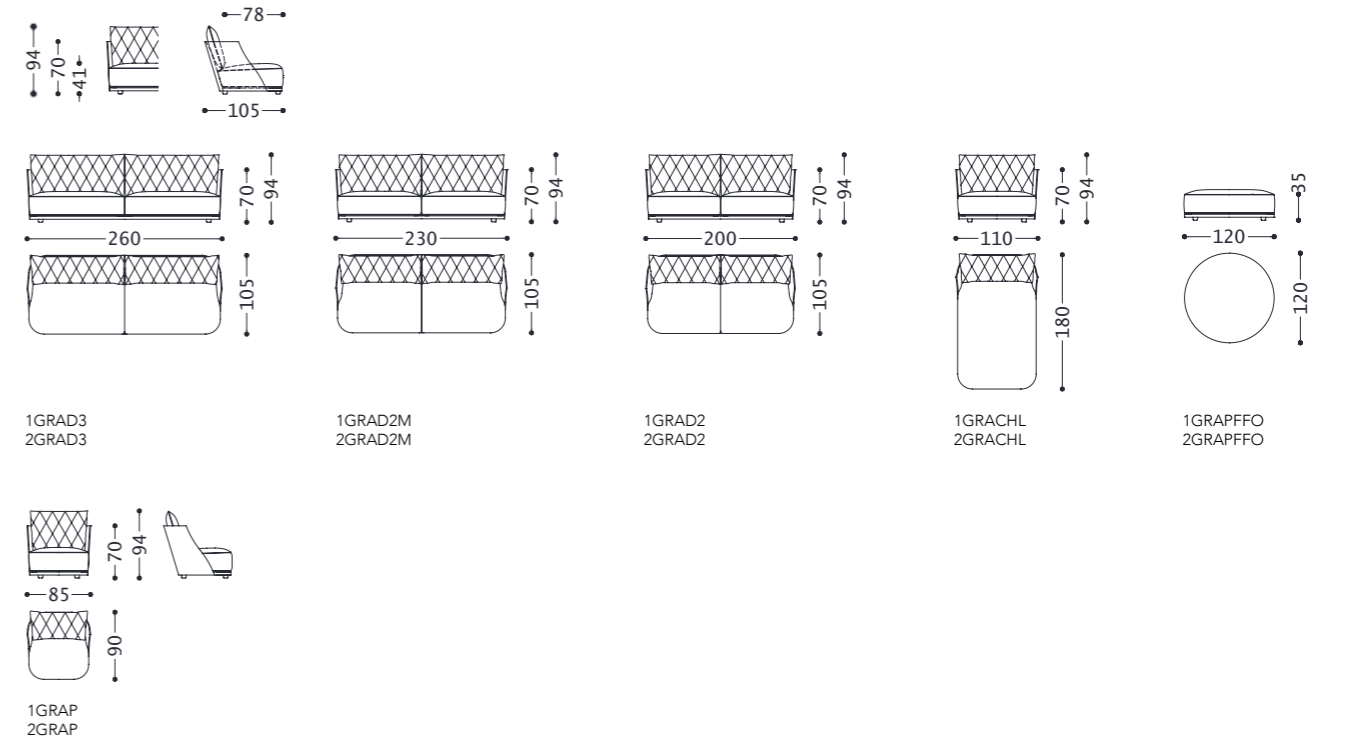

divano/sofa **Stewart**

elementi/elements

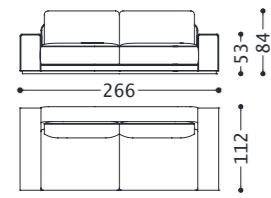
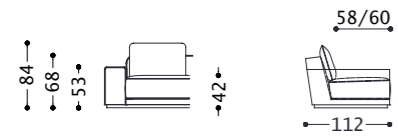

2STWD3MSP

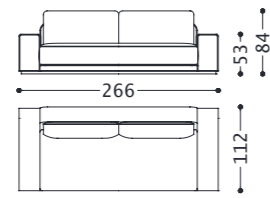

2STWD3M

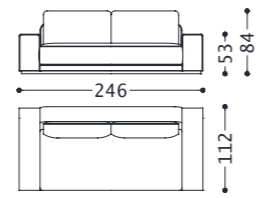

2STWD3

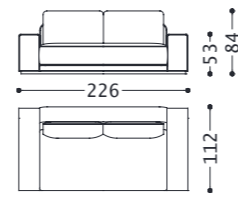

2STWD2M

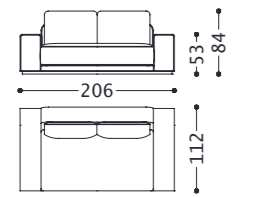

2STWD2

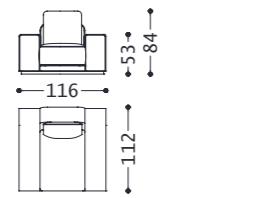

2STWP

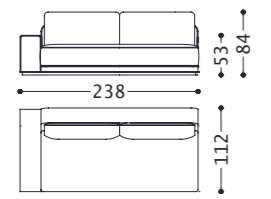

2STWD3MSX

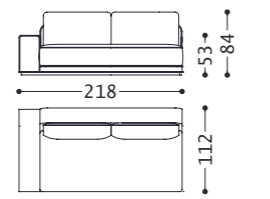

2STWD3SX

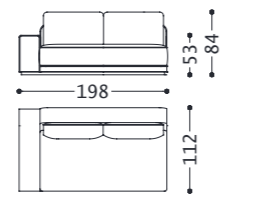

2STWD2MSX

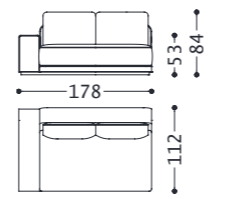

2STWD2SX

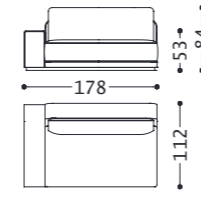

2STWD2SPSX

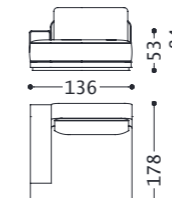

2STWDORMXSX

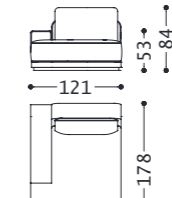

2STWDORMSX

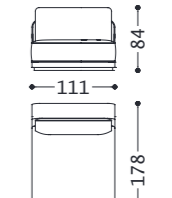

2STWCHL

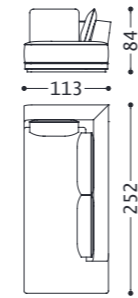

2STWMERSX

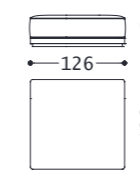

2STWPQG

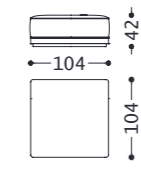

2STWPQP

divano/sofa **Stewart**

composizioni/compositions

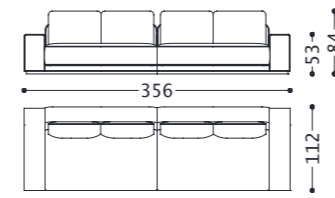

02STWC1

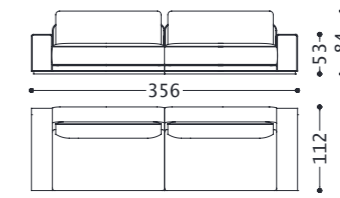

02STWC4

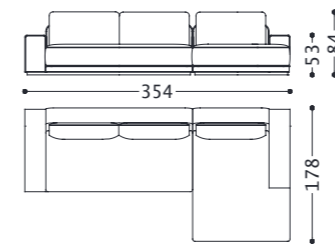

02STWC3

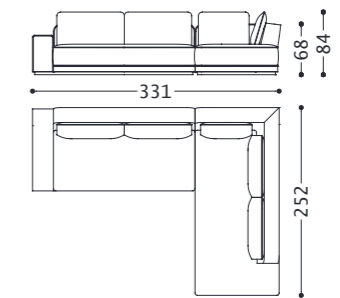

02STWC2

divano/sofa **Celine**

elementi/elements



Cod. Tessuto/fabric: 1/01  
Cod. Pelle/leather: 2/02

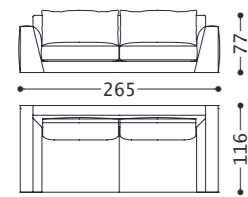

1CELEFAP  
2CELEFAP

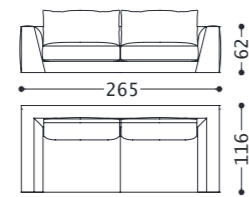

1CELEFBP  
2CELEFBP

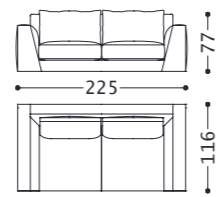

1CELEEAP  
2CELEEAP

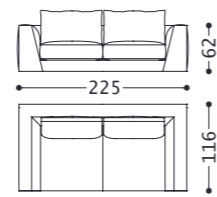

1CELEEBP  
2CELEEBP

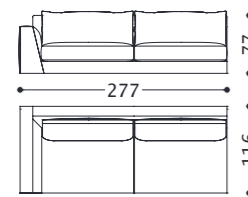

1CELEGASXP  
2CELEGASXP

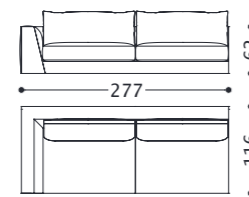

1CELEGBSXP  
2CELEGBSXP



1CELEFASXP  
2CELEFASXP

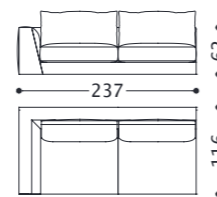

1CELEFBSXP  
2CELEFBSXP

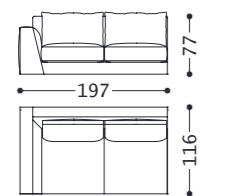

1CELEEASXP  
2CELEEASXP

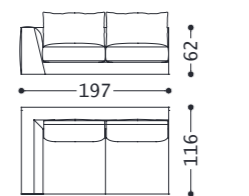

1CELEEBXP  
2CELEEBXP

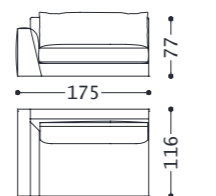

1CELEDASXP  
2CELEDASXP

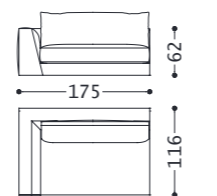

1CELEDBSXP  
2CELEDBSXP

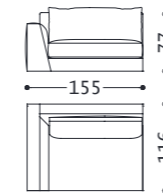

1CELECASXP  
2CELECASXP

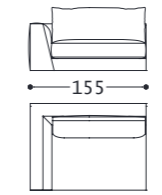

1CELECBSXP  
2CELECBSXP

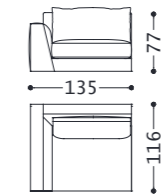

1CELEBASXP  
2CELEBASXP

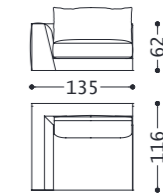

1CELEBBSXP  
2CELEBBSXP

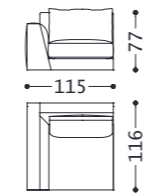

1CELEAASXP  
2CELEAASXP

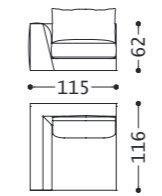

1CELEABSXP  
2CELEABSXP

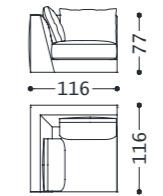

1CELEXAP  
2CELEXAP

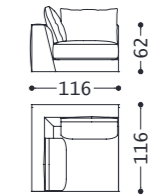

1CELEXBP  
2CELEXBP

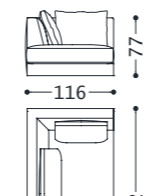

1CELEOASXP  
2CELEOASXP

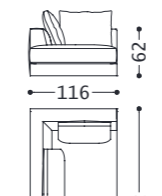

1CELEOBSXP  
2CELEOBSXP

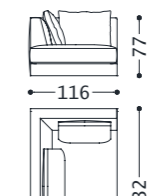

1CELENASXP  
2CELENASXP

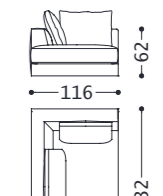

1CELENBSXP  
2CELENBSXP

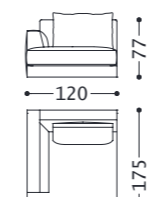

1CELEPASXP  
2CELEPASXP

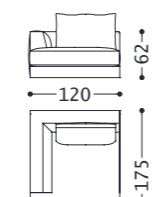

1CELEPBSXP  
2CELEPBSXP

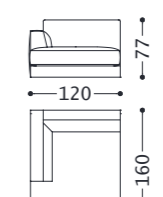

1CELEPASX  
2CELEPASX

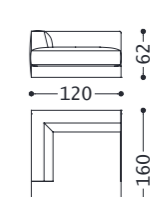

1CELEPBSX  
2CELEPBSX

divano/sofa **Celine**

elementi/elements



divano/sofa **Celine**

composizioni/compositions

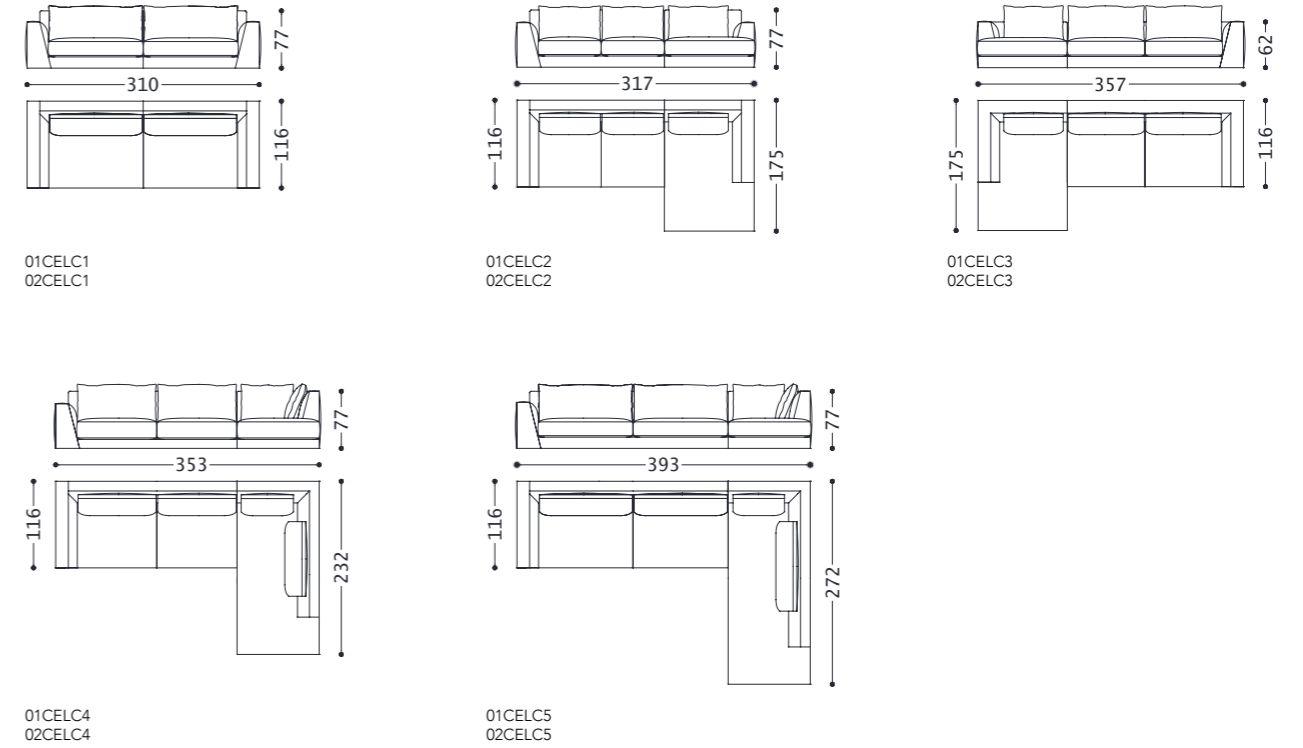

divano/sofa **Tracy**

elementi/elements



Cod. Tessuto/fabric: 1  
Cod. Pelle/leather: 2

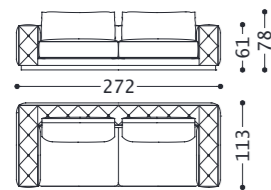
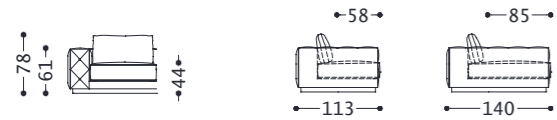

1TRCD3M  
2TRCD3M

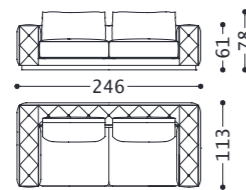

1TRCD3  
2TRCD3

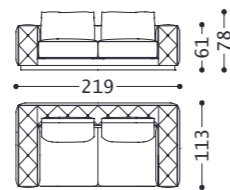

1TRCD2M  
2TRCD2M

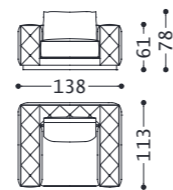

1TRCPL  
2TRCPL

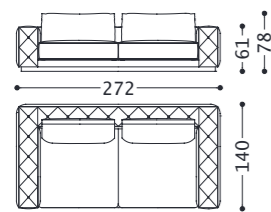

1TRCD3MPR  
2TRCD3MPR

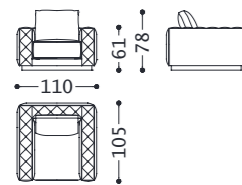

1TRCPS  
2TRCPS

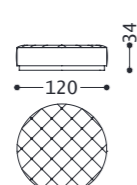

1TRCPOUFF  
2TRCPOUFF

sedia/chair **Samantha**

elementi/elements



Cod. Tessuto/fabric: 1  
Cod. Pelle/leather: 2

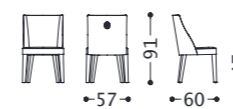

1SAMSECM  
2SAMSECM

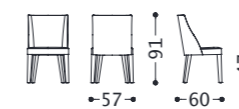

1SAMSESM  
2SAMSESM

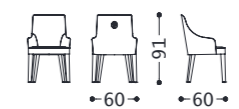

1SAMSECMCB  
2SAMSECMCB

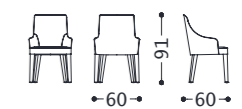

1SAMSESMCB  
2SAMSESMCB

sedia/chair **Ingrid**

elementi/elements



Cod. Tessuto/fabric: 1  
Cod. Pelle/leather: 2

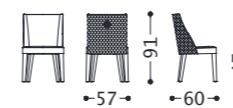

1INGSECM  
2INGSECM

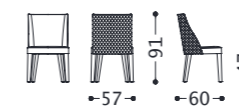

1INGSESM  
2INGSESM

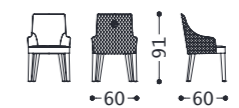

1INGSECMCB  
2INGSECMCB

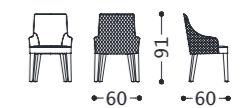

1INGSESMCB  
2INGSESMCB

tavolo/table **Humphrey**

elementi/elements

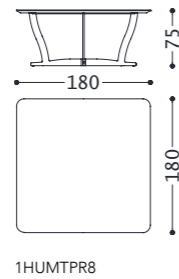
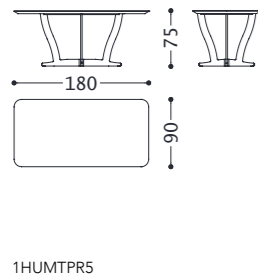
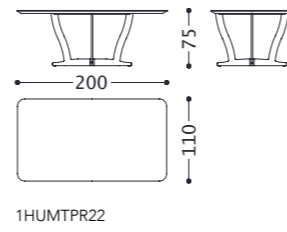
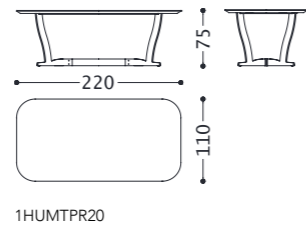
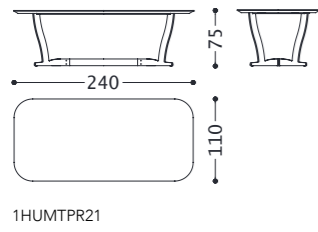
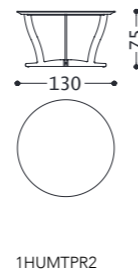
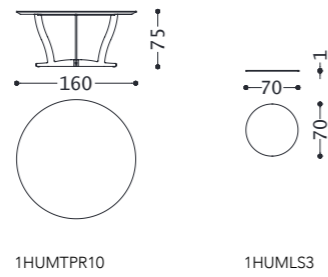
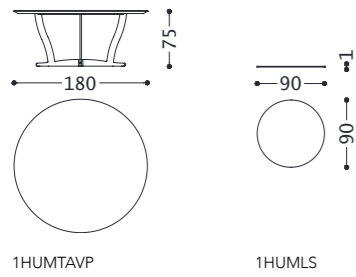

tavolo/table **Judy**

elementi/elements



(\*) Top ebano/ebony  
(\*\*) Top noce canaletto/canaletto walnut  
(\*\*\*) Top rovere scuro/dark oak

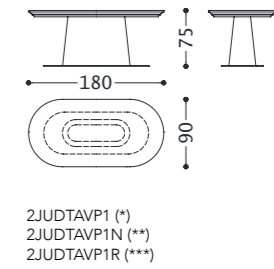
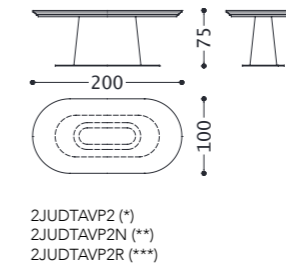
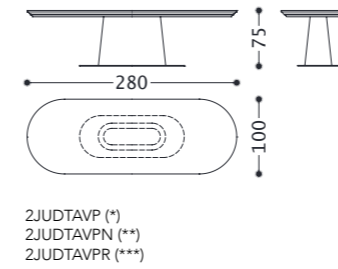
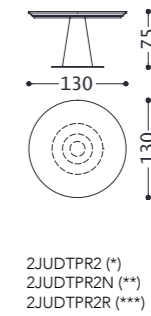
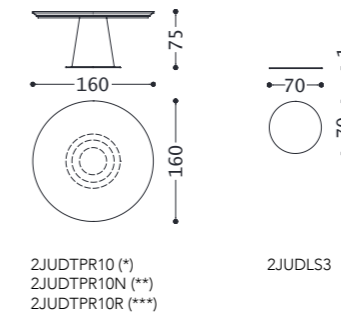
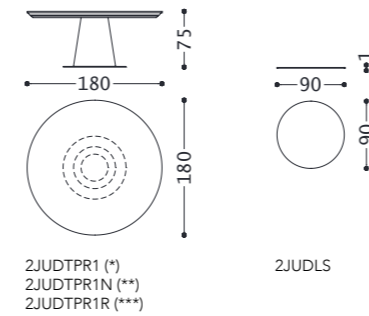

mobili/furniture **Alexander**

elementi/elements



(\*): Top marmo/marble  
 (\*\*): Top laccato/lacquered  
 (\*\*\*): Top ebano/ebony

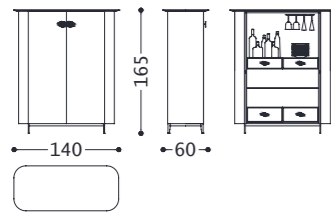

03ALEC6 (\*)  
 03ALEC13 (\*\*)  
 03ALEC20 (\*\*\*)

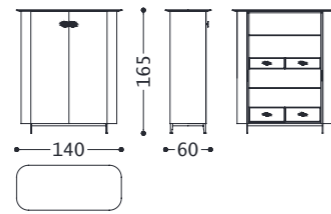

03ALEC7 (\*)  
 03ALEC14 (\*\*)  
 03ALEC24 (\*\*\*)

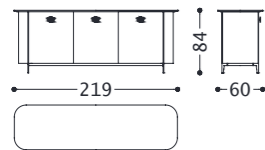

03ALEC2 (\*)  
 03ALEC9 (\*\*)  
 03ALEC16 (\*\*\*)

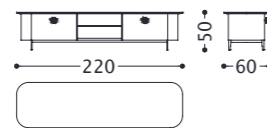

03ALEC4 (\*)  
 03ALEC11 (\*\*)  
 03ALEC18 (\*\*\*)

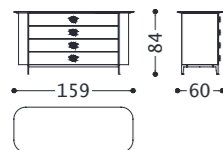

03ALEC3 (\*)  
 03ALEC17 (\*\*)  
 03ALEC10 (\*\*\*)

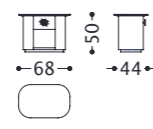

03ALEC1 (\*)  
 03ALEC8 (\*\*)  
 03ALEC15 (\*\*\*)

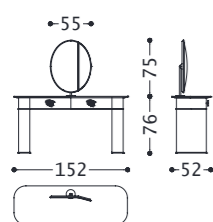

03ALEC5 (\*)  
 03ALEC12 (\*\*)  
 03ALEC19 (\*\*\*)

mobili/furniture **Jasmine**

elementi/elements

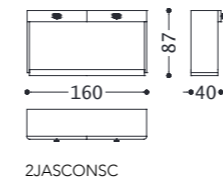

2JASCONSC

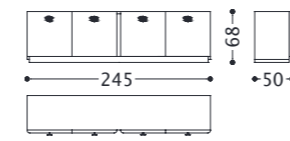

2JASCREDE

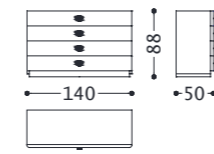

2JASDRW

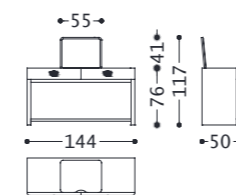

2JASTOISS



2JASMOTVC

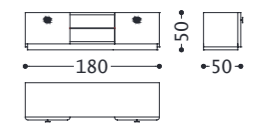

2JASMOTVS

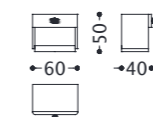

2JASCOMOD

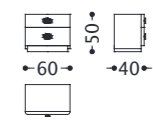

2JASCOMOD2



letto/bed **Vivien Royal**

elementi/elements

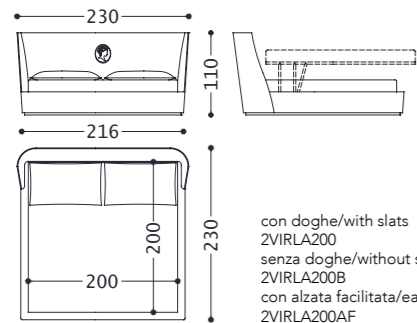
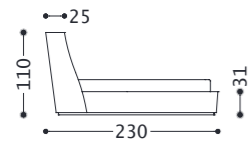

con doghe/with slats  
2VIRLA200  
senza doghe/without slats  
2VIRLA200B  
con alzata facilitata/easy lift mechanism  
2VIRLA200AF

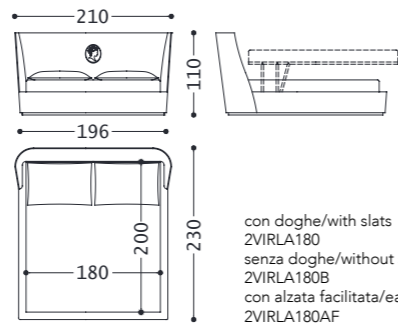

con doghe/with slats  
2VIRLA180  
senza doghe/without slats  
2VIRLA180B  
con alzata facilitata/easy lift mechanism  
2VIRLA180AF

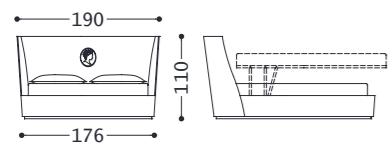

con doghe/with slats  
2VIRLA160  
senza doghe/without slats  
2VIRLA160B  
con alzata facilitata/easy lift mechanism  
2VIRLA160AF

panca/bench **Vivien Royal**

elementi/elements

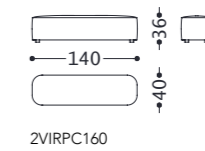
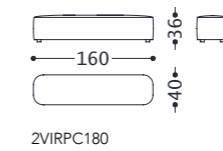
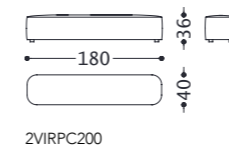

cuscini e coordinati letti/pillows and bedding set

elementi/elements

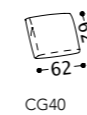

CG40



188CQ60P



CQ55SCP40

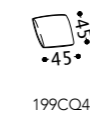

199CQ45



CQ45SP40



177CQRI  
2C41CQRI



177CQRIL  
2C41CQRIL



1VILCQ60P

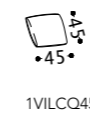

1VILCQ45

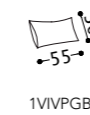

1VIVPGB  
2VIVPGB



1VILCOPLA200

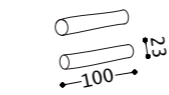

1VILCL200

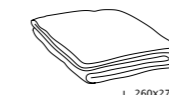

1VILCOPLA180

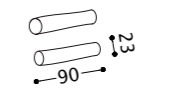

1VILCL180



1VILCOPLA160

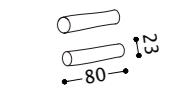

1VILCL160

consolle/console **Elizabeth** (wooden base)

elementi/elements

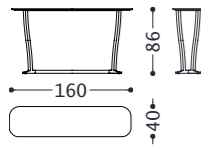

1ELICL86

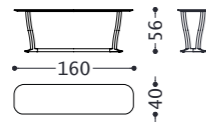

1ELICL56

consolle/console **Richard** (metal base)

elementi/elements

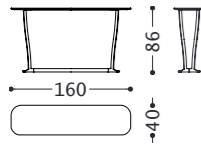

1RICCL86

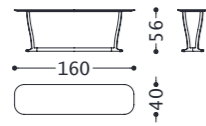

1RICCL56

tavolino/small table **Elizabeth** (wooden base)

elementi/elements

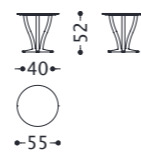

1ELITD55

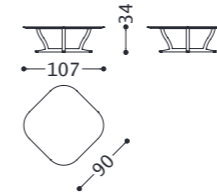

1ELITQ90

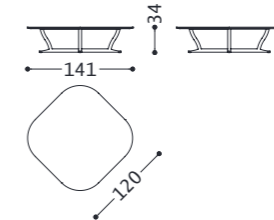

1ELITQ120

tavolino/small table **Richard** (metal base)

elementi/elements

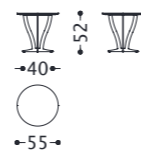

1RICTD55

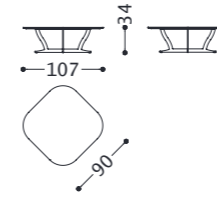

1RICTQ90

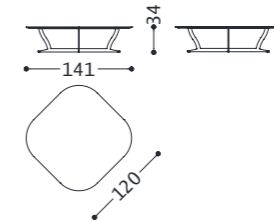

1RICTQ120

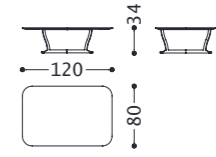

1RICTAVR

tavolo/table ~ tavolino/small table **Judy**

elementi/elements



(\*): Top noce canaletto o rovere scuro/canaletto walnut or dark oak  
 (\*\*): Top ebano/ebony  
 (\*\*\*) : Top laccato/lacquered



2JUDTD53 (\*)  
 2JUDTD53Q (\*\*)  
 2JUDTD53QL (\*\*\*)

2JUDTD90 (\*)  
 2JUDTD90Q (\*\*)  
 2JUDTD90QL (\*\*\*)

lampada/light **Natalie**

elementi/elements

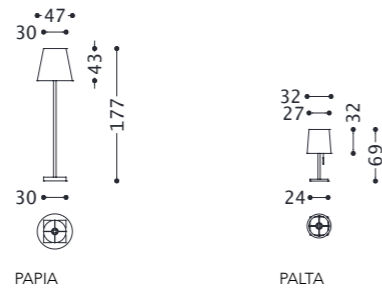

PAPIA

PALTA

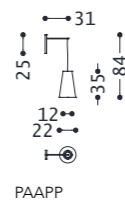

PAAPP

specchio/mirror **Joan**

elementi/elements

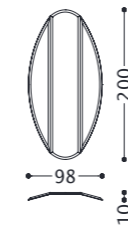

JOASPEO

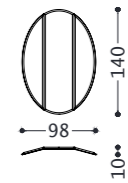

JOASPEOS

specchio/mirror **Lauren**

elementi/elements

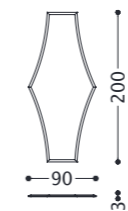

LAUSPEE



# CONTROLUCÈ

ITALIAN HOME FASHION

Art Direction  
Product Development  
Set Coordination  
Graphic Project  
**Castello Lagravinese Studio**



Photography  
**Daide Cerati**  
Styling  
**Paola Annunziata**  
Graphic assistance  
**Bplus marketing**  
Color Separation  
**GM Studio 1**



Special thanks to  
**Sigma L2**  
**Carpet Edition**

**alberta**

via Toniolo 41, 31028 Vazzola (TV) - ITALY  
[www.alberta.it](http://www.alberta.it)

**alberta**

via Toniolo 41, 31028 Vazzola (TV) - ITALY

[www.alberta.it](http://www.alberta.it)