

Afro-SG.....	340
Afro-SGQ	344
Afro-SGT.....	344
Anais-SG.....	300
Anais-SGB.....	302
Bouchon	326
Bouchon-SGA	330
Bouchon-SGB	330
Chloe-SGB	304
Cool-SG	348
Coquille-SG.....	288
Dot-P-SG.....	310
Dot-SG	310
Dot-SGB	314
Echo-SGB	318
Ego-P-SG	352
Fly-SGB	298
Gel-R-SGB	320
Gel-SGB	320
Jude-P-SG	306
Jude-SGT	306
Pick-M-SGA	334
Pick-M-SGB	334
Pick-SG.....	338
Playa-P-SG	324
Playa-SGB.....	322
Style-SGB	290
Style-SGT	294
Swing-SGT	350
Traffic-SGB	316

Sgabelli
Stools
Hocker
Tabourets
Taburetes



Coquille-SG



Coquille-SG

designed by
Radice & Orlandini • Patented



Misure / Measures



118	60	58	61	104
96			83	82

Finiture / Finishes

Base
Base

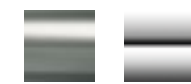

AS C

Seduta
Seat

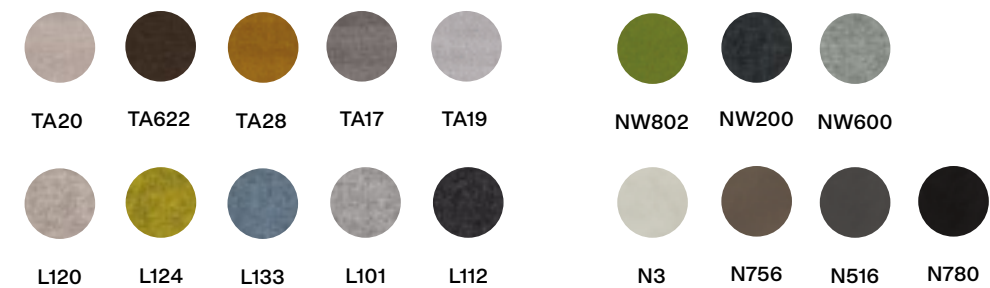

Style-SGB





Style-SGB

designed by
Radice & Orlandini • Patented



Misure / Measures



Finiture / Finishes

Gambe
Legs

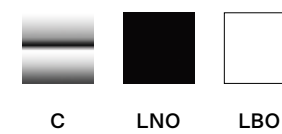

Seduta
Seat

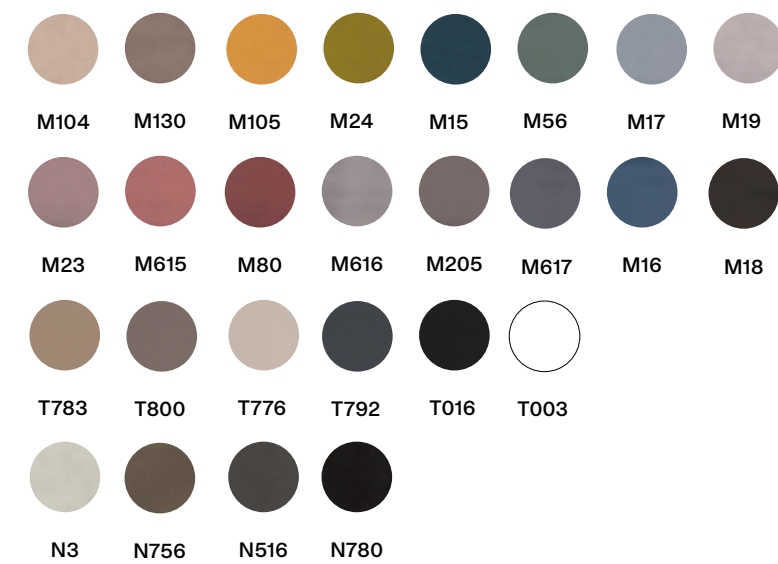

Style-SGT





Style-SGT

designed by
Radice & Orlandini • Patented



Misure / Measures



Finiture / Finishes

Base
Base

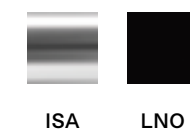

Seduta
Seat

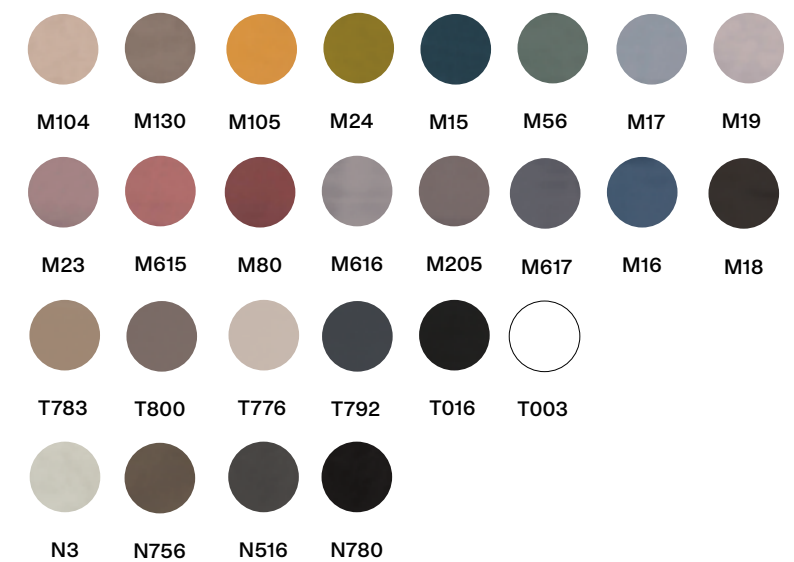

Fly-SGB



Fly-SGB

designed by
Radice & Orlandini • Patented



Misure / Measures



98 53 53,5 67

Finiture / Finishes

Gambe
Legs



C LNO LBO

Seduta
Seat



LN LB FRS NCA

Anais-SG



Anais-SG

designed by
Domitalia • Patented



Misure / Measures

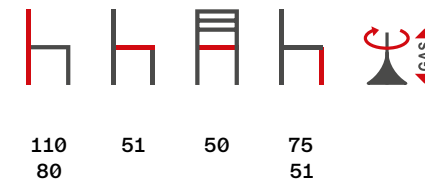

Finiture / Finishes

Base
Base



LNO

Seduta
Seat



TA20 TA622 TA28 TA17 TA19



N3 N756 N516 N780



B9 B14 B7 B8 B1

Anais-SGB



302

Anais-SGB

designed by
Domitalia • Patented



Misure / Measures

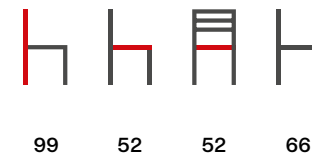

Finiture / Finishes

Gambe
Legs

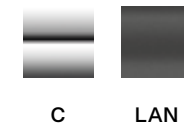

Seduta
Seat



303

Chloe-SGB



Chloe-SGB

designed by
Domitalia • Patented



Misure / Measures

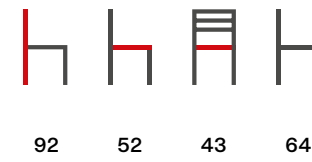

Finiture / Finishes

Rivestimento
Upsholstery

BO615	BO05	BO622	BO017	BO0100
TA20	TA622	TA28	TA17	TA19
PS	PC	PTM	PN	PB
N3	N756	N516	N780	

Jude





Jude

designed by
Domitalia • Patented



JUDE-P-SG



JUDE-SGT

Misure / Measures

JUDE-P-SG

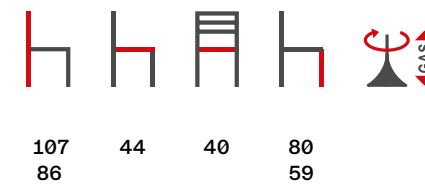

JUDE-SGT

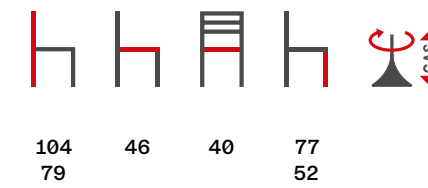

Finiture / Finishes

JUDE-P-SG

Base
Base

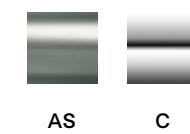

Seduta
Seat

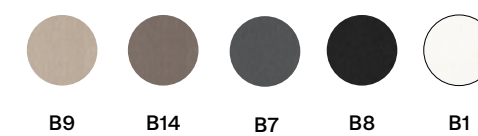

JUDE-SGT

Base
Base

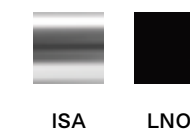

Seduta
Seat

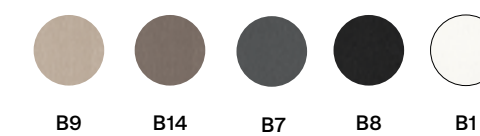

Dot-SG





Dot-SG

designed by
Radice & Orlandini • Patented



DOT-SG



DOT-P-SG

Misure / Measures

DOT-SG

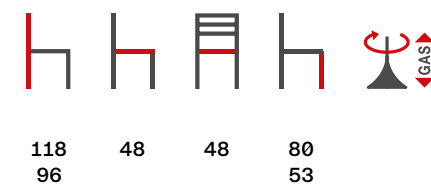

DOT-P-SG



Finiture / Finishes

DOT-SG

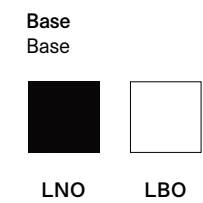

Seduta
Seat



DOT-P-SG

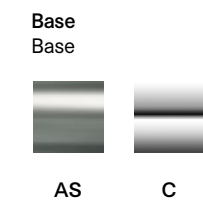

Dot-SGB



Dot-M
→ P. 226

Dot-SGB

designed by
Radice & Orlandini • Patented



Misure / Measures

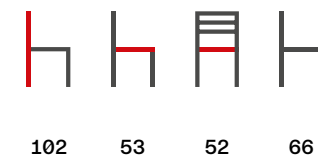

Finiture / Finishes

Gambe
Legs

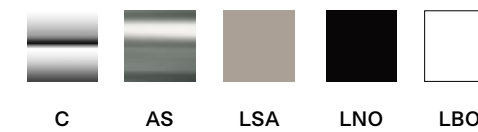

Seduta
Seat

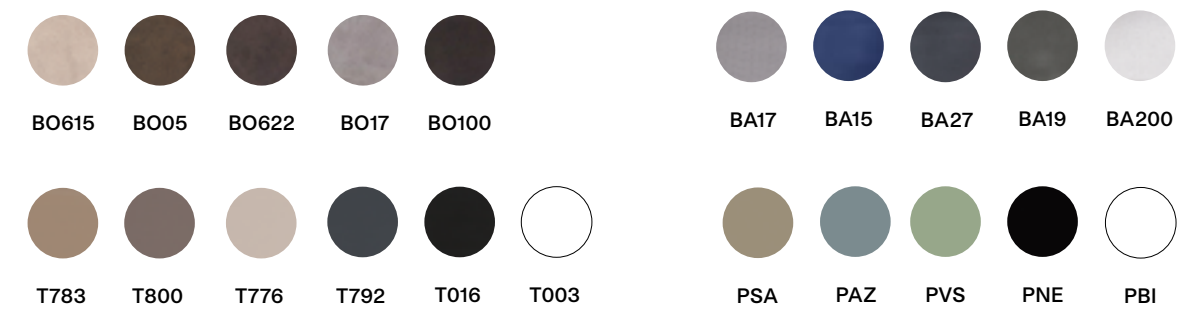

Traffic-SGB



Traffic-SGB

designed by
Radice & Orlandini • Patented



Misure / Measures

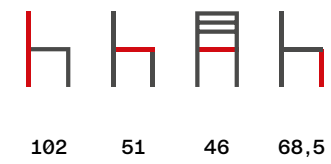

Finiture / Finishes

Gambe
Legs

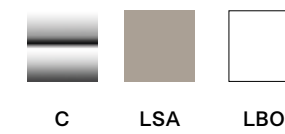

Seduta
Seat



Echo-SGB



Echo-SGB

designed by
Arter & Citton • Patented



Misure / Measures



103 53 50 65

Finiture / Finishes

Gambe
Legs



AS C LBO

Seduta
Seat



PMT PVA PNE PBI

Gel-SG



Gel-SG

designed by
Domitalia • Patented

GEL-SGB



GEL-R-SGB



Misure / Measures

GEL-SGB



102 52 48 65

GEL-R-SGB



105 56 44 65

Finiture / Finishes

GEL-SGB

Gambe
Legs



AS C LAN LBO

Seduta
Seat



SOR SRO SVE SAZ



SFU STR SBI

GEL-P-SGB

Gambe
Legs

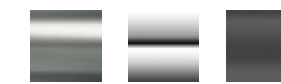

AS C LAN

Seduta
Seat



SOR SRO SVE SAZ



SFU STR SBI

Playa-SGB



322

Playa-SGB

designed by
Fabrizio Batoni • Patented



Misure / Measures



103 53 50 67

Finiture / Finishes

Gambe
Legs



C

Seduta
Seat

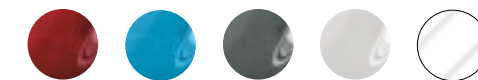

SBO SAZ SFU STR SBI

323

Playa-P-SG



324

Playa-P-SG

designed by
Fabrizio Batoni • Patented



Misure / Measures

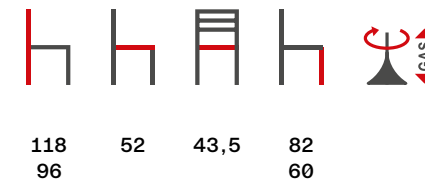

Finiture / Finishes

Base
Base



C

Seduta
Seat

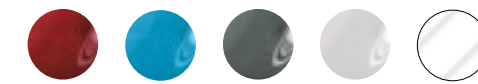

SBO SAZ SFU STR SBI

325

Bouchon





Bouchon

designed by
Radice & Orlandini • Patented



Misure / Measures

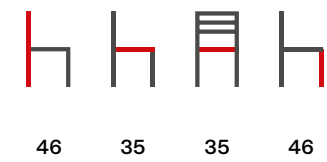

Finiture / Finishes

Base
Base

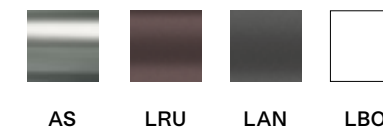

Seduta
Seat



Seduta personalizzabile su richiesta
Customizable seat upon request



Bouchon-SG



330



331



Bouchon-SG

designed by
Radice & Orlandini • Patented

BOUCHON-SGA



BOUCHON-SGB



Misure / Measures

BOUCHON-SGA

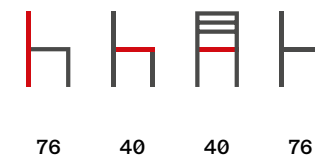

BOUCHON-SGB

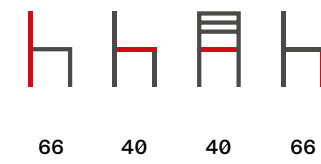

Finiture / Finishes

Base
Base



Seduta
Seat



Seduta personalizzabile su richiesta
Customizable seat upon request



Pick-M





Pick-M

designed by
Radice & Orlandini • Patented



PICK-M-SGA



PICK-M-SGB

Misure / Measures

PICK-M-SGA

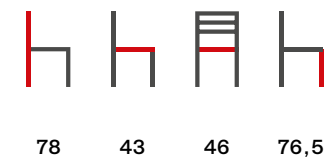

PICK-M-SGB

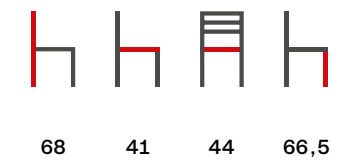

Finiture / Finishes

Gambe
Legs



Seduta
Seat



Seduta personalizzabile su richiesta
Customizable seat upon request



Pick-SG



338

Pick-SG

designed by
Radice & Orlandini • Patented



Misure / Measures

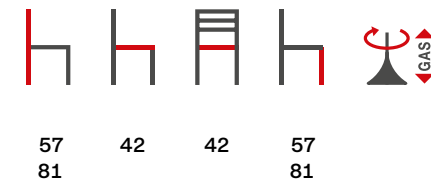

Finiture / Finishes

Base
Base



LNO LBO

Seduta
Seat



SU BO615 BO05 BO622 BO17 BO100

Seduta personalizzabile su richiesta
Customizable seat upon request



339

Afro-SG





Afro-SG

designed by
Domitalia • Patented



Misure / Measures

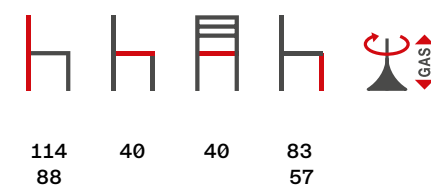

Finiture / Finishes

Base
Base

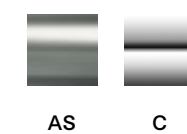

Seduta
Seat



Afro-SGQ
Afro-SGT





Afro-SGQ
Afro-SGT

designed by
Domitalia • Patented



AFRO-SGQ



AFRO-SGT

Misure / Measures

AFRO-SGQ

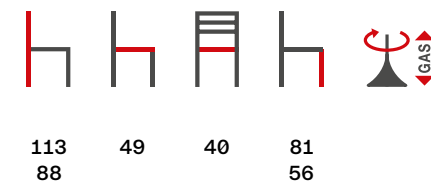

AFRO-SGT

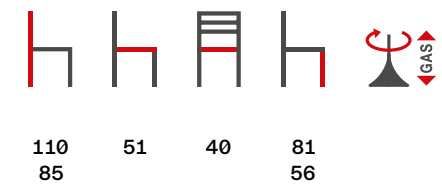

Finiture / Finishes

AFRO-SGQ

Base
Base



C

AFRO-SGT



ISA



LNO

Seduta
Seat



BO615 BO05 BO622 BO017 BO100



B9 B14 B7 B8 B1

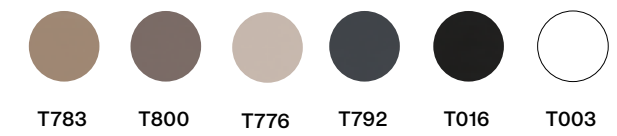

T783 T800 T776 T792 T016 T003

Cool-SG



Cool-SG

designed by
Domitalia • Patented



Misure / Measures

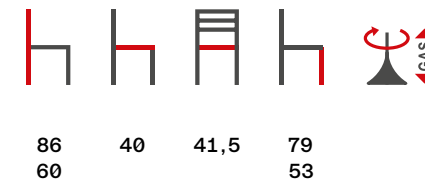

Finiture / Finishes

Base
Base

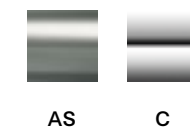

Seduta
Seat



Swing-SG



350

Swing-SG

designed by
Domitalia • Patented



Misure / Measures

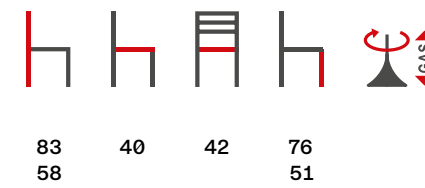

Finiture / Finishes

Base
Base



ISA LNO

Seduta
Seat



RTO RTM RGR RNE RBI

351

Ego-P-SG



Ego-P-SG

designed by
Domitalia • Patented



Misure / Measures

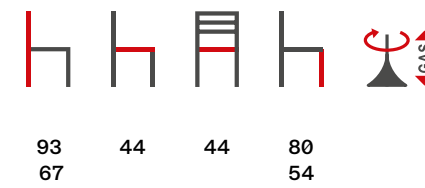

Finiture / Finishes

Base
Base

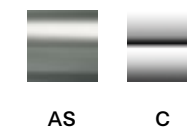

Seduta
Seat

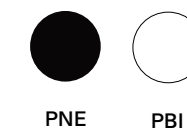

App.....	418
Babà	434
Babà-JR	434
Cargo-2C	376
Cargo-3	372
Casper	430
Contour-125.....	356
Contour-185.....	360
Contour-TV	366
Cross-QA	400
Cross-QB	400
Cross-R	400
Ok-4	438
Ok-7	442
Ok-8	446
Ok-9	450
Ok-NB.....	454
Ok-NE.....	458
Phantom	426
Phantom-D	426
Sushi-10	406
Sushi-C.....	410
Sushi-L	414
Terra-VA	422
Terra-VB	422
Urban-A	380
Urban-CG	384
Urban-LG	388
Urban-LO	392
Urban-LS	396

Complementi
 Occasionals
 Beimöbel
 Accessoires
 Complementos

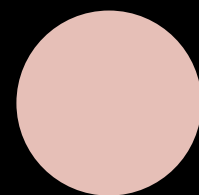
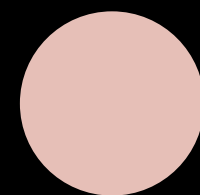
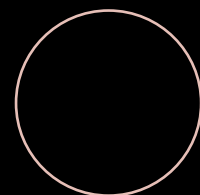
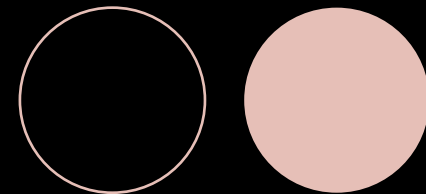
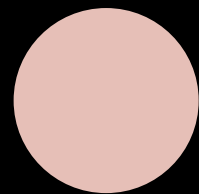
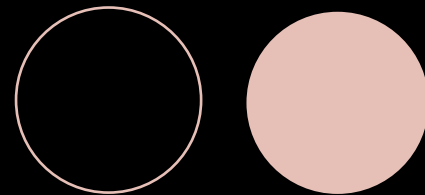
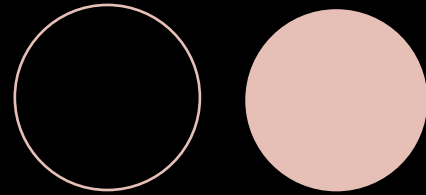
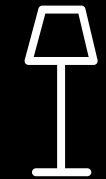
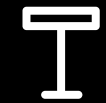
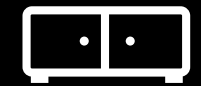

Contour-125



Sierra
→ P. 208





Contour-125

designed by
Paul Stott • Patented



Misure / Dimensions cm

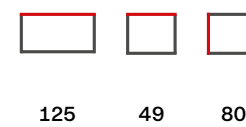

125 49 80

Finiture / Finishes

**Struttura
Structure**



LTO LAN LBO

**Zoccolo
Plinth**



FRS NCA LTO LAN LBO

**Anta centrale
Central door**



FRS NCA LTO LAN LBO



CMA CBR COC COS CVC

**Piano
Top**



CMA CBR COC COS CVC



MCA MEM VCA VAA VBA

Contour-185





Flexa-LX
→ P. 204

Euclide-A
100x200 (+50+50) cm
→ P. 28



Flexa-LX
→ P. 204

Urban-LO
→ P. 392

Contour-185

designed by
Paul Stott • Patented



Misure / Dimensions cm

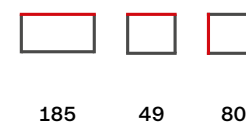

Finiture / Finishes

**Struttura
Structure**



**Zoccolo
Plinth**

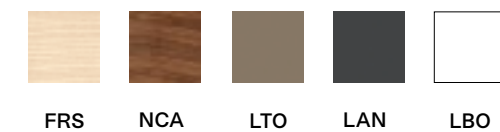

**Anta centrale
Central door**

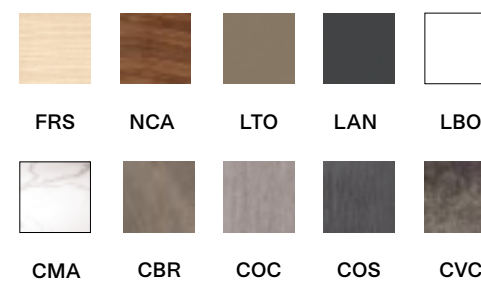

**Piano
Top**

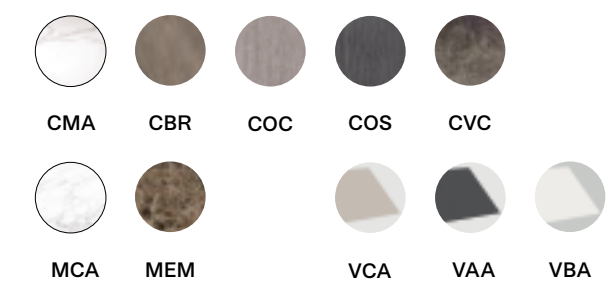

Contour-TV



Urban-CG
→ P. 384





Contour-TV

designed by
Paul Stott • Patented



Misure / Dimensions cm



Finiture / Finishes

**Struttura
Structure**



**Zoccolo
Plinth**

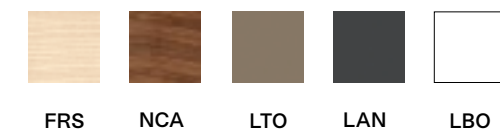

**Anta centrale
Central door**

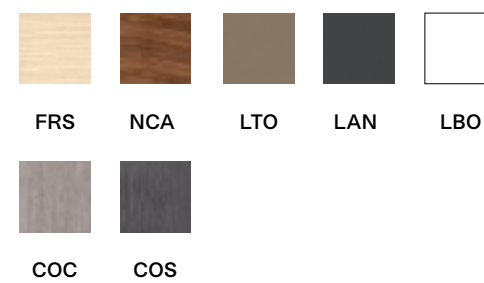

**Piano
Top**

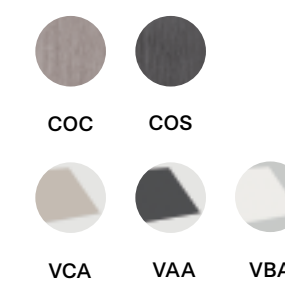



Cargo-3





Cargo-3

designed by
Domitalia • Patented



Misure / Dimensions cm



Finiture / Finishes

Struttura
Structure



LAN RNS

Struttura
Structure



LAN RCI

Ante
Doors



RNS

Ante
Doors



RCI

Cargo-2C



Fenice-L
→ P. 182





Cargo-2C

designed by
Domitalia • Patented



Misure / Dimensions cm



Finiture / Finishes

Struttura
Structure



LAN RNS

Ante e cassetti
Doors and drawers fronts



RNS

Struttura
Structure



LAN RCI

Ante e cassetti
Doors and drawers fronts



RCI

Urban-A



T
Traffic
→ P. 234



Urban-A

designed by
Radice & Orlandini • Patented

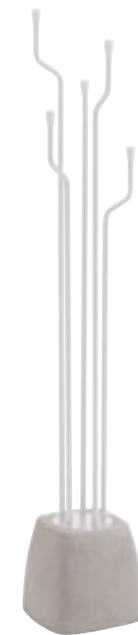
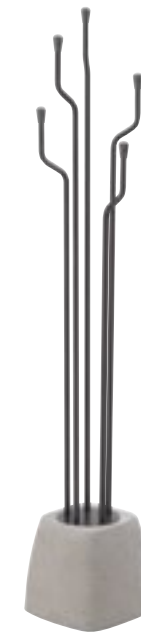

Misure / Dimensions cm



32 32 180

Finiture / Finishes

Struttura
Frame

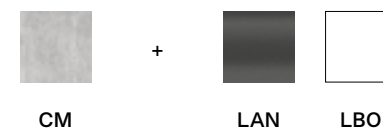

Pomoli
Knobs



Urban-CG



Contour-TV
160x49xH44 cm
→ P. 366





Urban-CG

designed by
Radice & Orlandini • Patented



Misure / Dimensions cm

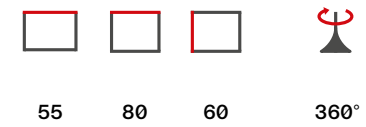

55 80 60 360°

Finiture / Finishes

Struttura
Frame

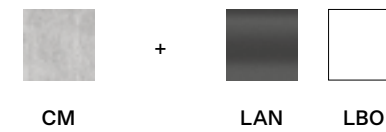

Piano laminato Fenix nano Tech Matt
Fenix nano Tech Matt laminate top

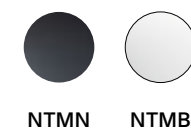

Urban-LG





Universe-160
90x160 (+50+50+50) cm
→ P. 92



Sierra
→ P. 208





 Cross-QA
 50x50 H60 cm
 → P. 400

 Cross-QB
 50x50 H50 cm
 → P. 400

Urban-LG

designed by
 Radice & Orlandini • Patented



Misure / Dimensions cm



Finiture / Finishes

Struttura
Frame

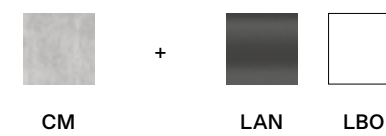

Paralume
Lampshade



Urban-LO



Globe
→ P. 242



Corona-120
ø 119 cm
→ P. 110





Diva
→ P. 160



Tuile-FE
130x280 cm
→ P. 20



Contour-185
185x49xH80 cm
→ P. 360

Urban-LO

designed by
Radice & Orlandini • Patented

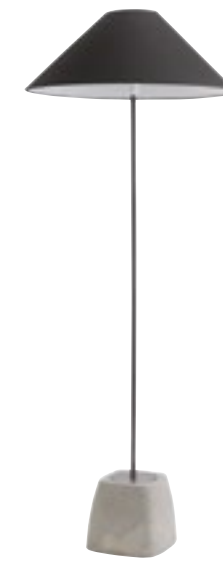

Misure / Dimensions cm



81 81 209

Finiture / Finishes

Struttura
Frame

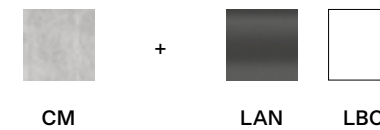

Paralume
Lampshade



Urban-LS



Traffic-T
→ P. 238



Archie-200
100x200 cm
→ P. 40





Opera
→ P. 188



Discovery
98x160 (+50+50) cm
→ P. 48

Urban-LS

designed by
Radice & Orlandini • Patented

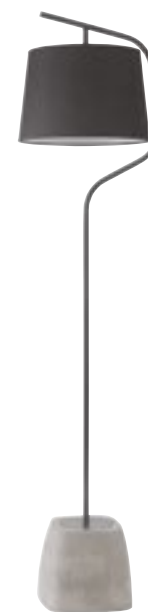

Misure / Dimensions cm



45 45 172

Finiture / Finishes

Struttura
Frame

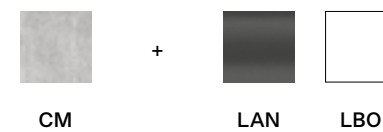

Paralume
Lampshade



Cross



Urban-LG
→ P. 388



Cross





Cross

designed by
Radice & Orlandini • Patented

CROSS-QA

CROSS-QB

CROSS-R



Misure / Dimensions cm

CROSS-QA

CROSS-QB

CROSS-R



50 50 60

50 50 50

110 70 40

50 50 62,5

50 50 52,5

98 70 42,5

Piano in HPL
HPL top

Piano in ceramica
Ceramic top

Finiture / Finishes

Base
Base



LSE LRO LAM LAN

Piano in laminato stratificato
High pressure laminate top



LSB

Piano in ceramica
Ceramic top



CMA CVC

Sushi-10





Sushi-10

designed by
Domitalia • Patented



Misure / Dimensions cm



98 98 31,7

Finiture / Finishes

Base
Base



C

Base
Base



LNO

Base
Base



LBO

Piano in MDF
MDF top



LSA LBO

Piano in ceramica
Ceramic top



CVC

Piano in MDF o ceramica
MDF or ceramic top



LBO CMA

Sushi-C





Sushi-C

designed by
Domitalia • Patented



Misure / Dimensions cm

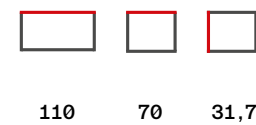

110 70 31,7

Finiture / Finishes

Base
Base



C

Base
Base



LNO

Base
Base



LBO

Piano in MDF
MDF top



LSA LBB

Piano in ceramica
Ceramic top



CVC

Piano in MDF o ceramica
MDF or ceramic top



LBB LBO CMA

Sushi-L



Urban-LG
→ P. 388



Sushi-L

designed by
Domitalia • Patented



Misure / Dimensions cm

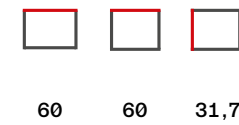

Finiture / Finishes

Base
Base



C

Base
Base



LNO

Base
Base



LBO

Piano in MDF
MDF top



LSA

LBB

Piano in ceramica
Ceramic top



CVC

Piano in MDF o ceramica
MDF or ceramic top



LBB

LBO

CMA

App





App

designed by
Radice & Orlandini • Patented



Misure / Dimensions cm



Finiture / Finishes

Gambe
Legs

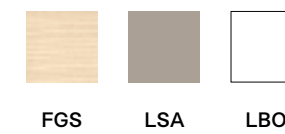

Vassoio
Tray

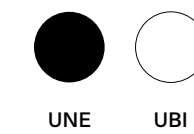

Piano
Top

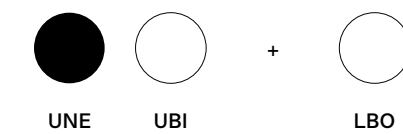
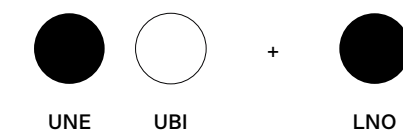
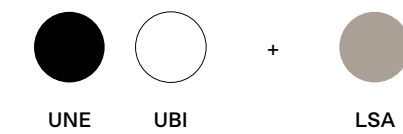

Terra-V

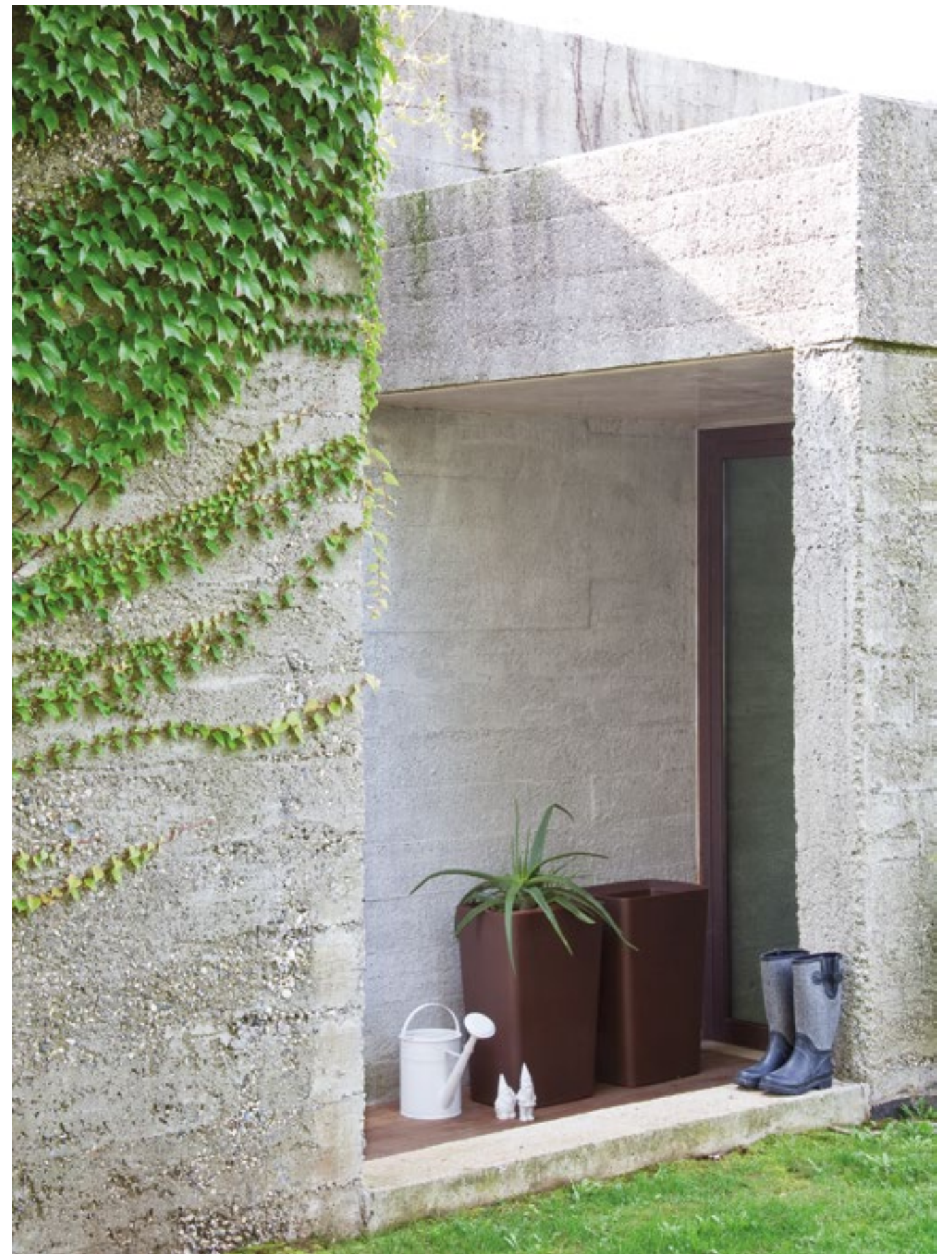



Terra-V

designed by
Arter & Citton • Patented



Misure / Dimensions cm

TERRA-VA

TERRA-VB



54 39 102



50 36 72



Finiture / Finishes

TERRA-VA

TERRA-VB



ERU EGR



ERU EGR

Optional kit di drenaggio
Optional drain kit

Phantom





Phantom

designed by
Radice & Orlandini • Patented



Misure / Dimensions cm

PHANTOM-P

PHANTOM-D

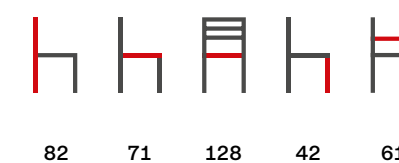
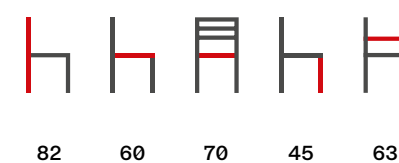

Finiture / Finishes



EBI

ETR

Casper





Casper

designed by
Radice & Orlandini • Patented



Misure / Dimensions cm



37,5 44 44

Finiture / Finishes

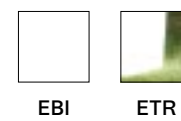

EBI ETR

Babà





Babà

designed by
Radice & Orlandini • Patented

BABÀ



BABÀ-JR



Misure / Dimensions cm

BABÀ

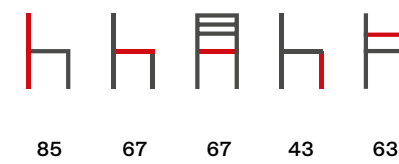

BABÀ-JR



Finiture / Finishes

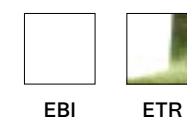

Ok-4





Ok-4

designed by
Domitalia • Patented

Misure / Dimensions cm

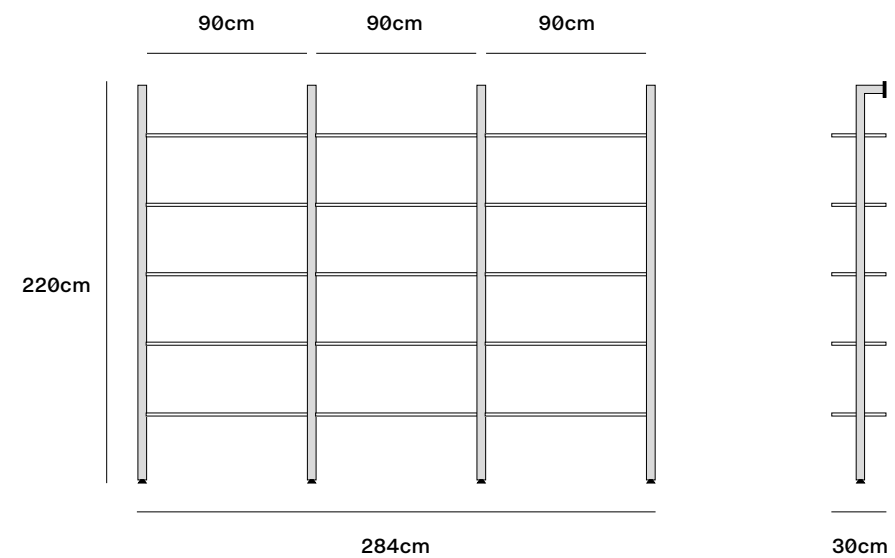

Finiture / Finishes

Montanti
Uprights



AN ANE

Ripiani impiallacciati, laccati o in vetro
Veneered, lacquered or glass shelves



RM LTO LBO



VS VNO

Ok-7



Cloud-A
→ P. 220





Ok-7

designed by
Domitalia • Patented

Misure / Dimensions cm

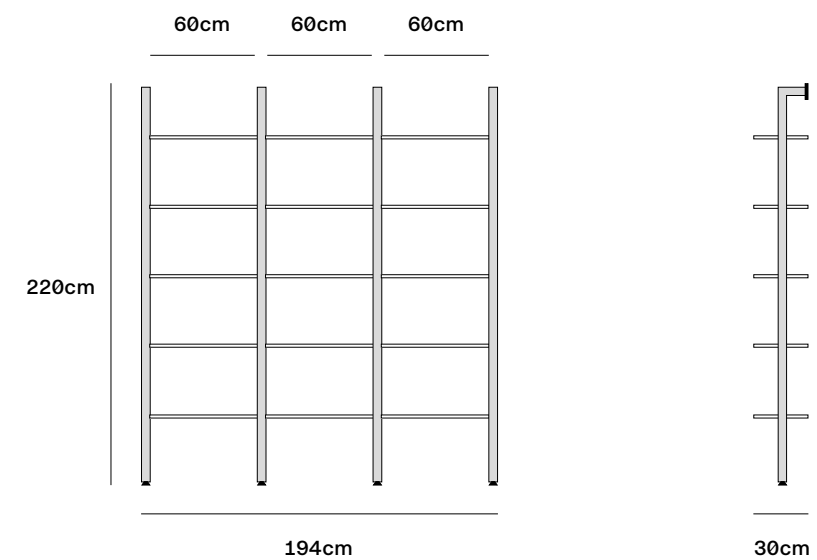

Finiture / Finishes

Montanti
Uprights



AN ANE

Ripiani impiallacciati, laccati o in vetro
Veneered, lacquered or glass shelves



RM LTO LBO



VS VNO





Ok-8

designed by
Domitalia • Patented

Misure / Dimensions cm

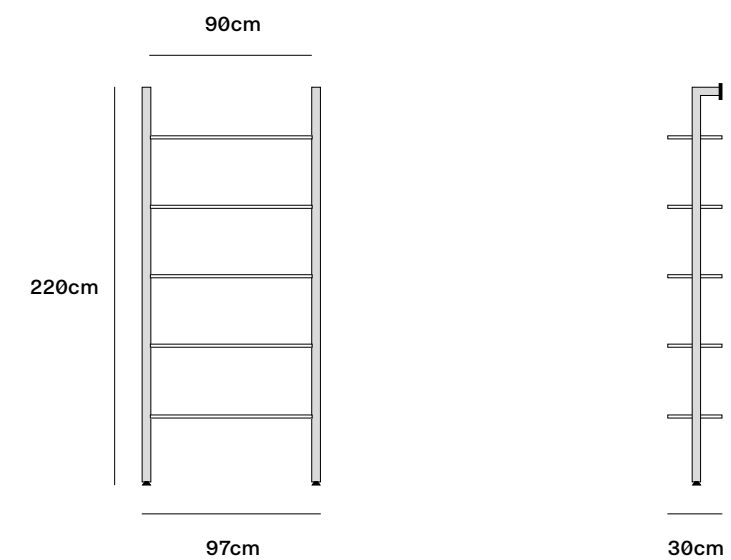

Finiture / Finishes

Montanti
Uprights



AN ANE

Ripiani impiallacciati, laccati o in vetro
Veneered, lacquered or glass shelves



RM LTO LBO



VS VNO

Ok-9



Gel-D
→ P. 264





Ok-9

designed by
Domitalia • Patented

Misure / Dimensions cm

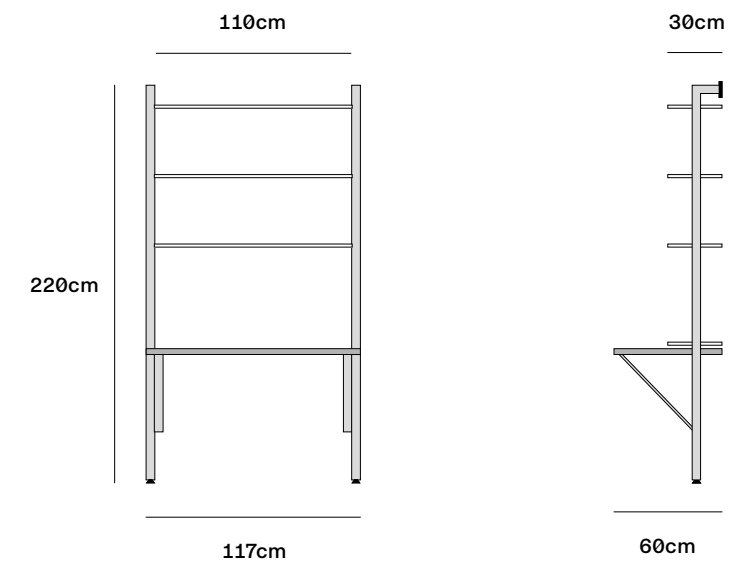

Finiture / Finishes

Montanti
Uprights



AN ANE

Ripiani impiallacciati, laccati o in vetro
Veneered, lacquered or glass shelves



VS VNO

Scrittoio in melaminico
Melamine desk



MBO

Ok-NB





Ok-NB

designed by
Domitalia • Patented

Misure / Dimensions cm

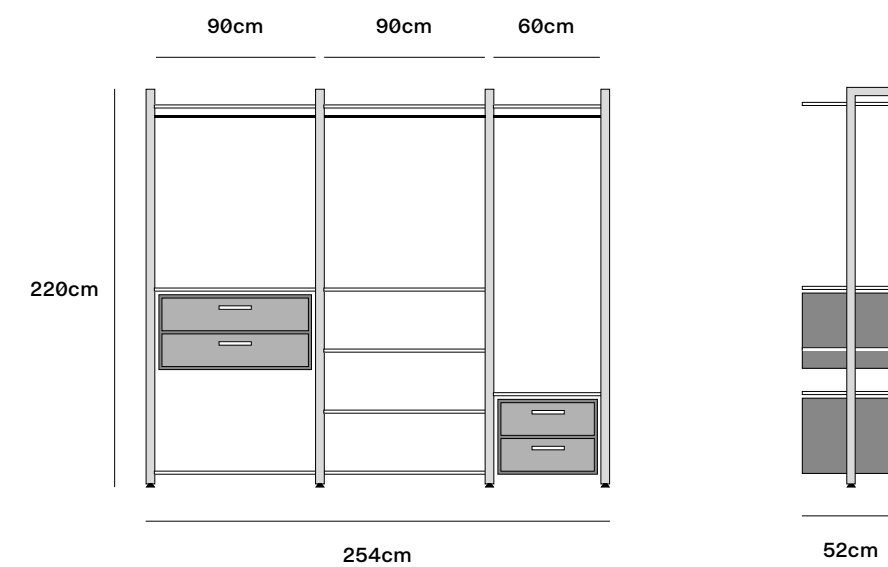

Finiture / Finishes

Montanti
Uprights



AN



ANE

Ripiani e cassetti in melaminico
Melamine shelves and drawers



MRM

OK-NE



OK-NE

designed by
Domitalia • Patented

Misure / Dimensions cm

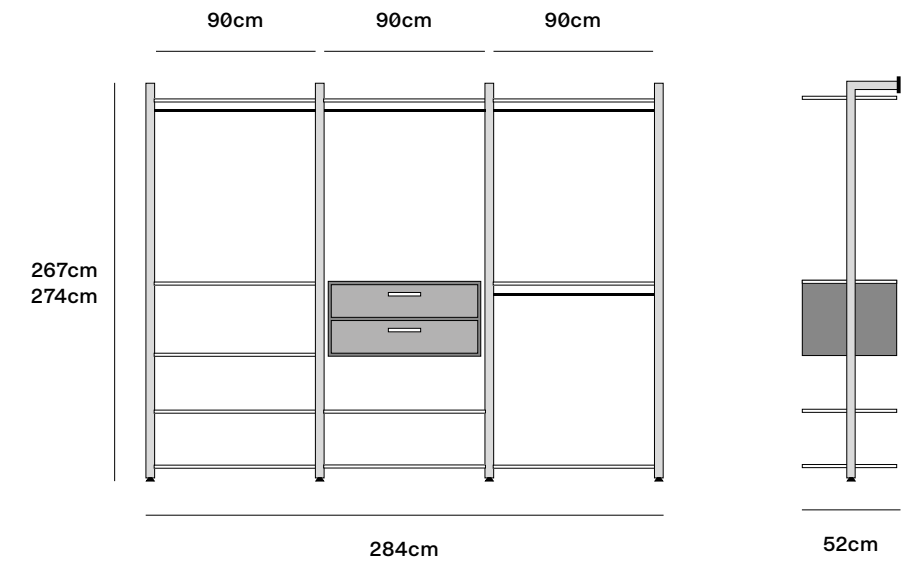

Finiture / Finishes

Montanti
Uprights



AN



ANE

Ripiani e cassetti in melaminico
Melamine shelves and drawers



MRM

Finiture
Finishes
Ausführungen
Finitions
Acabados

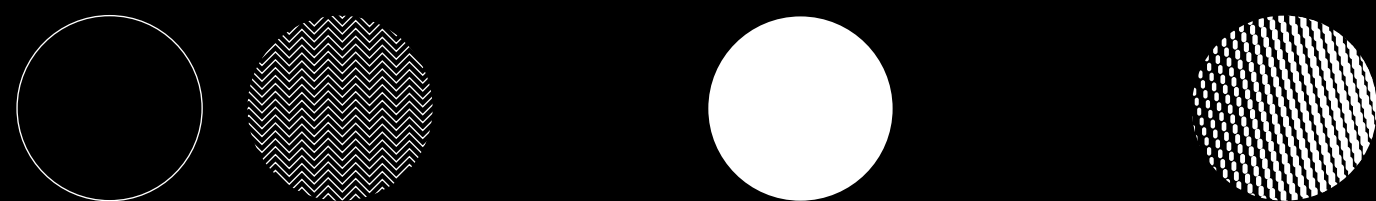
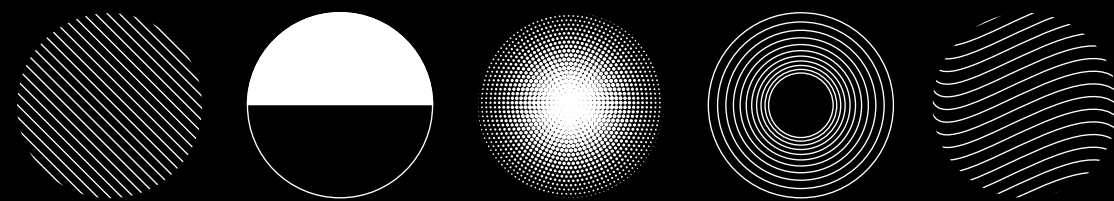
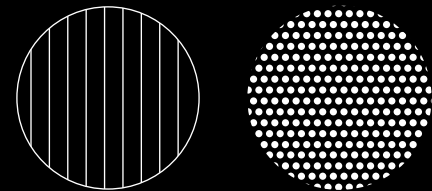

Finiture / Finishes

Legni verniciati - Varnished woods - Holz gebeizt - Bois vernis - Maderas acabadas

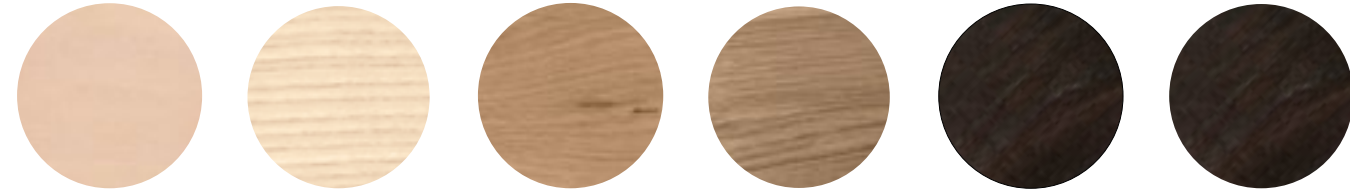

- | | | | | | |
|--|--|--|--|--|--|
| <p>FGS
Faggio sbiancato
White beechwood
Buche gekälkt
Hêtre blanchi
Haya blanco</p> | <p>FRS
Frassino sbiancato
White ashwood
Esche gekälkt
Frêne blanchi
Fresno blanco</p> | <p>RC2
Rovere chiaro su frassino
Ashwood tinted light oak
Hell eiche auf esche
Chêne clair sur frêne
Fresno acabado roble claro</p> | <p>RNS
Rovere nodato spazzolato
Brushed wild oak
Wildeiche gebürstet
Chêne sauvage brossé
Roble cepillado</p> | <p>WE
Wengè su faggio
Beechwood tinted wengè
Wengè auf buche
Wengè sur hêtre
Haya acabado wengè</p> | <p>RM
Wengè su frassino o rovere
Ashwood or oak tinted wengè
Wengè auf esche oder eiche
Wengè sur frêne ou chêne
Fresno o roble acabado wengè</p> |
|--|--|--|--|--|--|



- | | | |
|--|---|---|
| <p>NCA
Noce canaletto su faggio o frassino
Beechwood or ashwood tinted walnut canaletto
Nußbaum canaletto auf buche oder esche
Noyer canaletto sur hêtre ou frêne
Haya o fresno acabado nogal canaletto</p> | <p>RCI
Rovere chiaro massiccio invecchiato scortecciato
Solid aged and debarked light oak
Veraltetes und eintrindetes helleiche massivholz
Chêne clair massif vieilli et ecorcé
Roble claro macizo envejecido y descortezado</p> | <p>RSI
Rovere scuro massiccio invecchiato scortecciato
Solid aged and debarked dark oak
Veraltetes und eintrindetes dunkleiche massivholz
Chêne foncé massif vieilli et ecorcé
Roble oscuro macizo envejecido y descortezado</p> |
|--|---|---|

Legni laccati - Lacquered woods - Holz lackiert - Bois laqués - Maderas lacadas

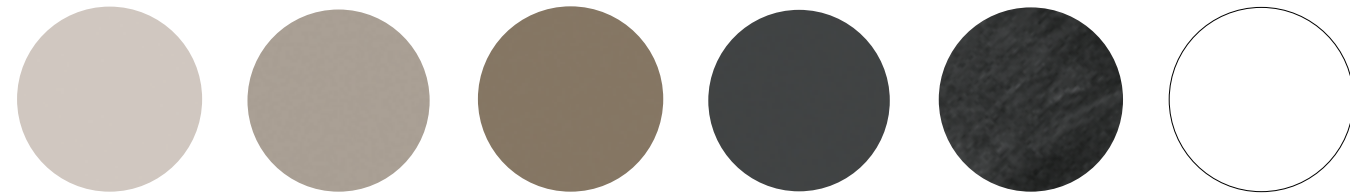

- | | | | | | |
|--|--|--|--|---|--|
| <p>LCO
Corda
Rope
Seil
Corde
Cuerda</p> | <p>LSA
Sabbia
Sand
Sand
Sable
Arena</p> | <p>LTO
Tortora
Taupe
Taubengrau
Taupe
Tórtora</p> | <p>LAN
Antracite su faggio
Beech anthracite lacquered
Anthrazit auf buche
Anthracite sur hêtre
Haya acabado gris oscuro</p> | <p>LAN2
Antracite poro aperto
Anthracite lacquered open pore
Anthrazit offen porig
Anthracite pore ouvert
Gris oscuro poro abierto</p> | <p>LBO
Bianco
White
Weiß
Blanc
Blanco</p> |
|--|--|--|--|---|--|



- | | |
|---|--|
| <p>LB2
Bianco poro aperto
White open pore
Weiß offen porig
Blanc pore ouvert
Blanco poro abierto</p> | <p>LBB
Bianco brillante
White high glossy
Weiß glänzend
Blanc brillant
Blanco alto brillo</p> |
|---|--|

Finiture / Finishes

Melaminici - Melamine - Melamin - Melamine - Melaminado

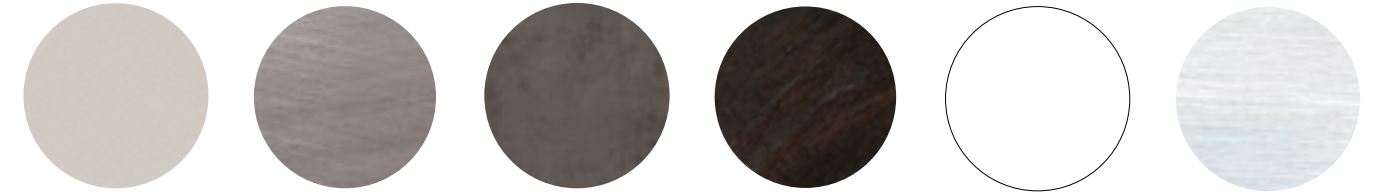

- | | | | | | |
|--|--|--|--|--|---|
| <p>MCO
Corda
Rope
Seil
Corde
Cuerda</p> | <p>MRI
Rovere invecchiato
Antique oak
Alter eichen
Chêne vieilli
Roble envejecido</p> | <p>MCM
Cemento
Cement
Zement
Ciment
Cemento</p> | <p>MRM
Wengè su frassino/rovere
Ashwood/oak tinted wengè
Wengè auf esche/eiche
Wengè sur frêne/chêne
Fresno/roble acabado wengè</p> | <p>MBO
Bianco
White
Weiß
Blanc
Blanco</p> | <p>MBL
Bianco strutturato
Textured white
Texturierten weiss
Blanc structuré
Blanco texturizado</p> |
|--|--|--|--|--|---|

Laminato - Laminate - Laminat - Stratifié - Laminado

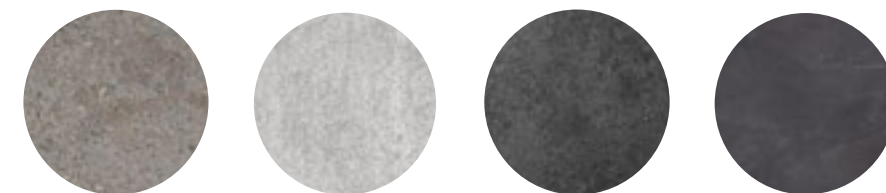

- | | | | |
|--|---|--|---|
| <p>LPT
Pietra tortora
Taupe slate
Schiefer taubengrau
Pierre taupe
Piedra tórtora</p> | <p>LC
Cemento
Cement
Zement
Ciment
Cemento</p> | <p>LAD
Ardesia
Grey slate
Schiefer grau
Ardoise
Pizarra</p> | <p>LGR
Grafite
Graphite
Graphit
Graphite
Grafito</p> |
|--|---|--|---|

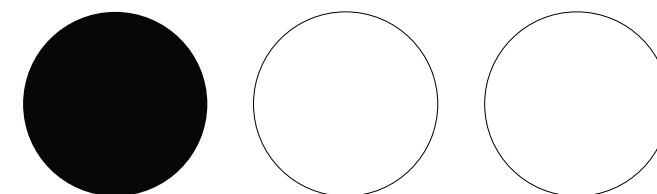

- | | | |
|--|---|---|
| <p>LN
Nero
Black
Schwarz
Noir
Negro</p> | <p>LB
Bianco
White
Weiß
Blanc
Blanco</p> | <p>LSB
Bianco strutturato
Textured white
Texturierten weiss
Blanc structure
Blanco texturizado</p> |
|--|---|---|



- | | |
|--|--|
| <p>NMN*
Laminato fenix nano tech matt nero
Black fenix nano tech matt laminate
Schwarz fenix nano tech matt laminat
Stratifé fenix nano tech mat noir
laminado fenix nano tech mate negro</p> | <p>NMB*
Laminato fenix nano tech matt bianco
White fenix nano tech matt laminate
Weiss fenix nano tech matt laminat
Stratifé fenix nano tech mat blanc
Laminado fenix nano tech mate blanco</p> |
|--|--|

* CARATTERISTICHE FENIX NANO TECH

- Superficie estremamente opaca
- Riparabilità termica dei micrograffi - anti-impronta
- Morbidezza al tatto
- Resistenza ai graffi e all'abrasione - igienico
- Idoneo al contatto con gli alimenti
- Facile da pulire
- Antimuffa
- Antistatico
- Idrorepellente
- Elevata stabilità alla luce
- Resistenza al calore secco
- Resistenza ai solventi acidi e reagenti di uso domestico

* FENIX NANO TECH FEATURES

- Low light reflectivity, extremely matt surface
- Thermal healing of microscratches
- Anti-fingerprint
- Soft touch
- Resistance to scratches and abrasion
- Hygienic
- Suitable for contact with food
- Easy to clean
- Mold-resistant
- Antistatic
- Hydro-repellent
- Lightfastness
- Resistance to dry heat
- High resistance to acid solvent and household reagents

Finiture / Finishes

Acciaio – Steel – Stahl – Acier – Acero

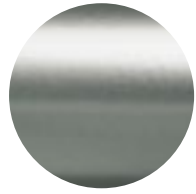

AS
Alluminio satinato
Satinated aluminium
Alufarbig satiniert
Aluminium satiné
Aluminio satinado

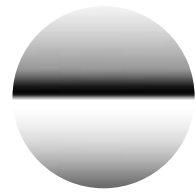

C
Cromato
Chromed
Verchromt
Chrome
Cromado

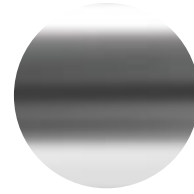

ISA
Inox satinato
Stainless steel
Edelstahl
Acier inox
Acero inoxidable

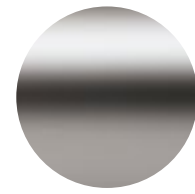

NIS
Nichel spazzolato
Brushed nickel
Edelstahl optik
Nickel brossé
Niquel cepillado



AN
Alluminio anodizzato
Anodized aluminium
Eloxiertes aluminium
Aluminium anodisé
Aluminio anodizado



LSA
Sabbia opaco
Sand matt
Sand matt
Sable mat
Arena mate

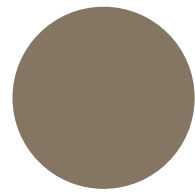

LTO
Tortora opaco
Taupe matt
Taubengrau matt
Taupe mat
Tórtora mate

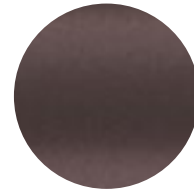

LRU
Ruggine opaco
Rust matt
Rost matt
Rouille mat
Herrumbre mate

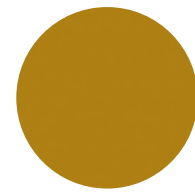

LSE
Senape opaco
Mustard matt
Senf matt
Moutarde mat
Mostaza mate

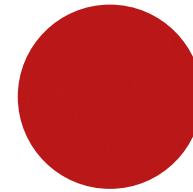

LRO
Rosso opaco
Red matt
Rot matt
Rouge mat
Rojo mate

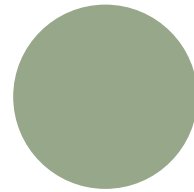

LVS
Verde salvia opaco
Light green matt
Hellgrün matt
Vert sauge mat
Verde claro mate

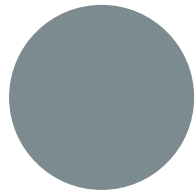

LAZ
Azzurro opaco
Light blue matt
Hellblau matt
Azur mat
Azul mate

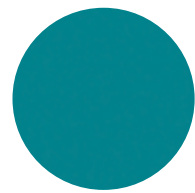

LAM
Acquamarina opaco
Turquoise matt
Türkis matt
Turquoise mat
Turquesa mate

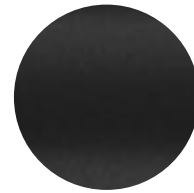

LAN
Antracite opaco
Anthracite matt
Anthrazit matt
Anthracite mat
Gris oscuro mate

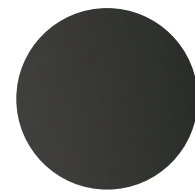

ANE
Alluminio anodizzato nero
Black anodized aluminium
Eloxiertes aluminium
schwarz
Aluminium anodisé noir
Aluminio anodizado negro

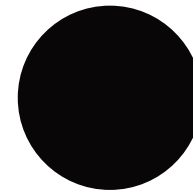

LNO
Nero opaco
Black matt
Schwarz matt
Noir mat
Negro mate

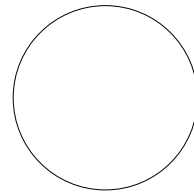

LBO
Bianco opaco
White matt
Weiß matt
Blanc mat
Blanco mate

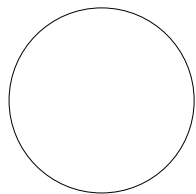

LBOE
Bianco opaco (uso esterno)
White matt (outdoor use)
Weiß matt (aussenbereich)
Blanc mat (pour l'extérieur)
Blanco mate (para exterior)

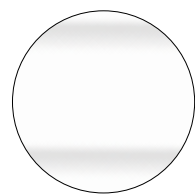

LBB
Bianco brillante
White glossy
Weiß glänzend
Blanc brillant
Blanco alto brillo

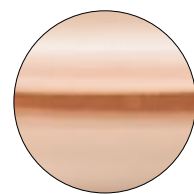

OR
Oro rosa
Rose gold
Rosafarbenen goldes
Or rosé
Oro Rosado

Finiture / Finishes

Vetro temprato – Tempered glass – Sicherheitglas – Verre trempé – Vidrio templado



VS
Serigrafato
Screen printed
Satiniert
Serigraphié
Serigrafado



VT
Trasparente, filo lucido
Transparent, straight edge
Transparent, gerade kante
Transparent, chant droit
Transparente, borde recto

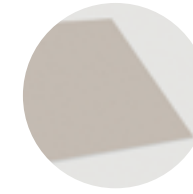

VCA
Acidato corda
Rope acid-etched
Seil satiniert
Corde traité à l'acide
Cuerda tratado al ácido



VTS
Smoke trasparente
Transparent smoke
Transparent rauch
Fumé transparent
Humo transparente



VAA
Acidato antracite
Anthracite acid-etched
Anthrazit satiniert
Anthracite traité à l'acide
Gris oscuro tratado al ácido

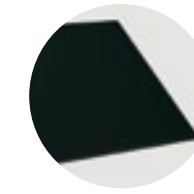

VNO
Verniciato nero
Black varnished
Schwarz lackiert
Verni noir
Pintado negro



VB
Extra bianco
Extra white
Extra weiß
Extra blanc
Extra blanco

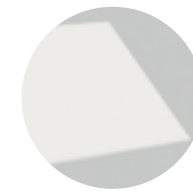

VBA
Acidato bianco
White acid-etched
Weiss satiniert
Blanc traité à l'acide
Blanco tratado al ácido

Marmo – Marble – Marmor – Marbre – Mármol



MCA
Bianco carrara
White carrara
Carrara weiß
Blanc carrara
Blanco carrara

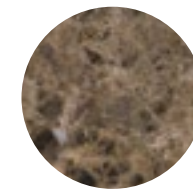

MEM
Emperador
Emperador
Emperador
Emperador
Emperador

Finiture / Finishes

Ceramica - Ceramic - Keramikglas - Céramique - Cerámica



CMA
Marmo bianco
White marble
Marmor weiss
Marbre blanc
Mármol blanco



CTR
Travertino
Travertine
Travertin
Travertin
Travertino



CTM
Taj Mahal



CST
Statuario



CCO
Calacatta oro



CAR
Arabesque



CBR
Brown
Brown
Braun
Marron
Marrón



CPG
Pietra grigia
Grey stone
Grau stein
Pierre grise
Piedra gris

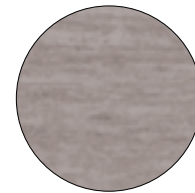

COC
Ossidiana chiara
Light obsidian
Obsidian hell
Obsidienne claire
Ossidiana clara

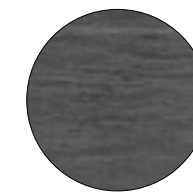

COS
Ossidiana scura
Dark obsidian
Obsidian dunkel
Obsidienne foncée
Ossidiana oscura



CVC
Cenere di vulcano
Volcano ash
Vulkanasche
Cendres de volcan
Ceniza de volcán



CQS
Quartzite stone

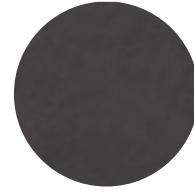

COP
Opium black

Finiture / Finishes

Sughero naturale - Natural cork - Naturkorken - Liège naturel - Corcho natural

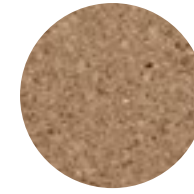

SU

La seduta in sughero può essere personalizzata con un logo a stampa laser di cui il cliente fornirà un file in formato vettoriale.

The cork seat can be personalized with a laser printing logo upon customer's vectorial file.

Der Sitz aus Korken kann mit einem Logo in Laserdruck personalisiert werden und der Kunde soll eine Datei in Vektor-Format schicken.

L'assise en liège peut être personnalisée avec un logo en impression laser et le client devra fournir un fichier dans un format vectoriel.

El asiento en corcho se puede personalizar con un logotipo en la impresión láser y el cliente tiene que proveer a enviar un file en formato vectorial.

Cemento - Concrete - Zement - Ciment - Cemento

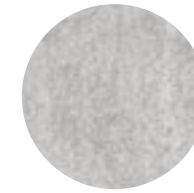

CM
Cemento
Concrete
Zement
Ciment
Cemento

Rete - Net - Netz - Filet - Red

Composizione
Composition:
30% PL, 70% PVC

Solidità alla luce
Light fastness:
>7

Resistenza all'abrasione
Abrasion resistance:
Martindale
≥ 100.000 cicli / cycles

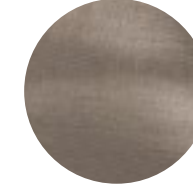

N6
Tortora
Taupe
Taubengrau
Taupe
Törtora

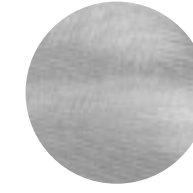

N4
Grigio chiaro
Light grey
Hell grau
Gris clair
Gris claro

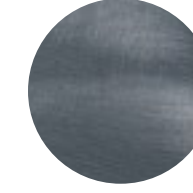

N5
Grigio scuro
Dark grey
Dunkel grau
Gris foncé
Gris oscuro

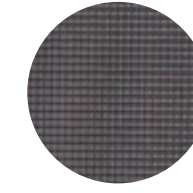

B0697
Antracite
Anthracite
Anthrazit
Anthracite
Gris oscuro

Finiture / Finishes

Poliuretano – Polyurethane – Polyurethan – Polyuréthane – Poliuretano

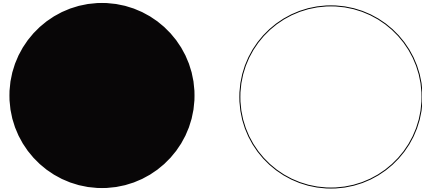

UNE
Nero
Black
Schwarz
Noir
Negro

UBI
Bianco
White
Weiß
Blanc
Blanco

Polipropilene – Polypropylene – Polypropylen – Polypropylène – Polipropileno

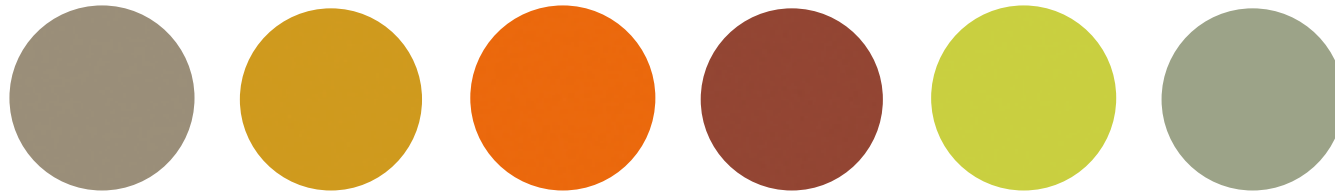

PSA
Sabbia
Sand
Sand
Sable
Arena

PSE
Senape
Mustard
Senf
Moutarde
Mostaza

PAR
Arancio
Orange
Orange
Orange
Naranja

PMT
Mattone
Brick red
Ziegelrot
Rouge brique
Rojo ladrillo

PVA
Verde acido
Pistacho green
Apfelgrün
Vert pistache
Verde pistacho

PVS
Verde salvia
Light green
Hellgrün
Vert sauge
Verde claro

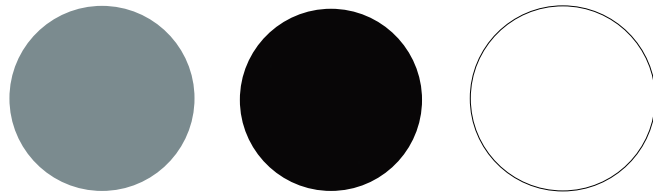

PAZ
Azzurro
Light blue
Hellblau
Azur
Azul

PNE
Nero
Black
Schwarz
Noir
Negro

PBI
White
Weiß
Blanc
Blanco

Policarbonato – Polycarbonate – Polycarbonat – Polycarbonate – Policarbonado

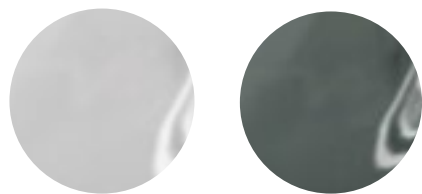

PCTR
Trasparente
Transparent
Transparent
Transparent
Transparente

PCFU
Fumé
Smoke grey
Rauchgrau
Fumé
Fumé

Finiture / Finishes

Stirene acrilico nitrile – Styrene acryl nitril – Styrol Acrylnitril – Styrene acryle nitrile – Stirene de nitril acrilico



SOR
Arancio
Orange
Orange
Orange
Naranja

SRO
Rosso
Red
Rot
Rouge
Rojo

SBO
Bordeaux
Bordeaux red
Bordeaux
Bordeaux
Burdeos

SVE
Verde
Green
Grün
Vert
Verde

SAZ
Azzurro
Light blue
Hellblau
Azur
Azul

SFU
Fumé
Smoke grey
Rauchgrau
Fumé
Fumé

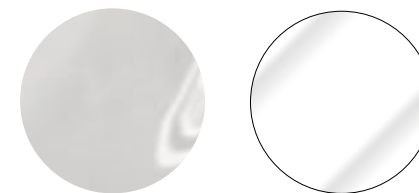

STR
Trasparente
Transparent
Transparent
Transparent
Trasparente

SBI
Bianco unito
White even
Weiß einig
Blanc uni
Blanco uniforme

Polietilene – Polyethylene – Polyethylen – Polyéthylène – Polietileno

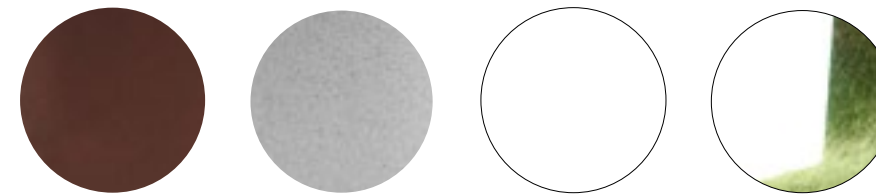

ERU
Ruggine
Rust
Rost
Rouille
Herrumbre

EGR
Granito
Granite
Granit
Granite
Granito

EBI
Bianco
White
Weiß
Blanc
Blanco

ETR
Traslucido
Translucent
Durchsichtig
Translucide
Traslucido

Finiture / Finishes

Tessuto / Fabric – Stoff – Tissu – Tejido

Bogotá

Composizione
Composition:
100% PL
Solidità alla luce
Light fastness:
≥ 4
Resistenza all'abrasione
Abrasion resistance:
Martindale
≥ 35.000 cicli / cycles



BO615
Beige
Beige
Beige
Beige
Beige



BO05
Tronco
Trunk
Stamm
Tronc
Tronco



BO622
Fumo
Smoke
Rauch
Fumé
Humo



BO17
Perla
Pearl
Perle
Perle
Perla



BO100
Asfalto
Road
Asphalt
Asphalte
Asfalto

Barbera

Composizione
Composition:
100% PL
Solidità alla luce
Light fastness:
≥ 4/5
Resistenza all'abrasione
Abrasion resistance:
Martindale
≥ 30.000 cicli / cycls

Idrorepellente e antimacchia
Water and stain-repellent



BA17
Perla
Pearl
Perle
Perle
Perla

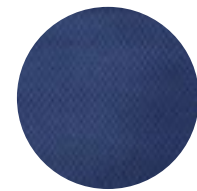

BA15
Azzurro
Light blue
Hellblau
Azur
Azul



BA27
Grigio
Grey
Grau
Gris
Gris

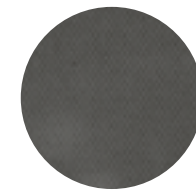

BA19
Cenere
Ash
Asche
Cendre
Ceniza

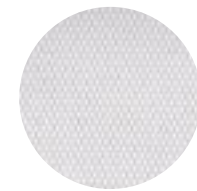

BA200
Bianco
White
Weiß
Blanc
Blanco

Tarantino

Composizione
Composition:
12% VI - 88% PL
Solidità alla luce
Light fastness:
≥ 4
Resistenza all'abrasione
Abrasion resistance:
Martindale
≥ 100.000 cicli / cycls



TA20
Sabbia
Sand
Sand
Sable
Arena



TA622
Castano
Chestnut
Kastanien braun
Chatain
Castaño

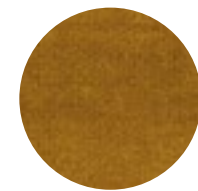

TA28
Zafferano
Saffron
Safran
Safran
Azafrán

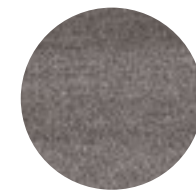

TA17
Cenere
Ash
Asche
Cendre
Ceniza

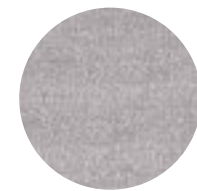

TA19
Perla
Pearl
Perle
Perle
Perla

Lanee

Composizione
Composition:
100% Wo
Solidità alla luce
Light fastness:
≥ 5
Resistenza all'abrasione
Abrasion resistance:
Martindale
≥ 50.000 cicli / cycls



L120
Beige
Beige
Beige
Beige
Beige

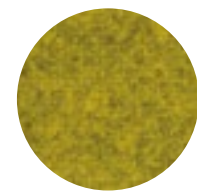

L124
Verde chiaro
Light green
Hell grün
Vert clair
Verde claro

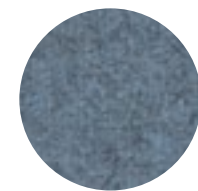

L133
Azzurro
Light blue
Hell blau
Azur
Azul claro

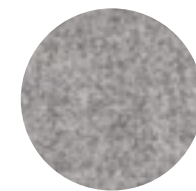

L101
Grigio chiaro
Light grey
Hell grau
Gris clair
Gris claro



L112
Grigio scuro
Dark grey
Dunkel grau
Gris foncé
Gris oscuro

Finiture / Finishes

Tessuto / Fabric – Stoff – Tissu – Tejido

Miraglio

Composizione
Composition:
100% PL
Solidità alla luce
Light fastness:
≥ 4
Resistenza all'abrasione
Abrasion resistance:
Martindale
≥ 100.000 cicli / cycls

Idrorepellente
Water-repellent

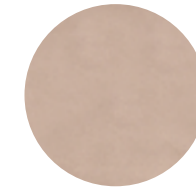

M104
Crema
Cream
Crème
Crème
Crema

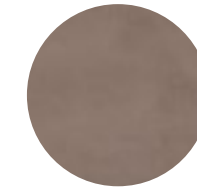

M130
Cachi
Khaki
Khaki
Kaki
Caqui

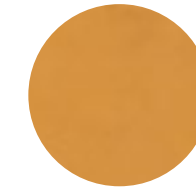

M105
Mandarino
Tangerine
Mandarine
Mandarin
Mandarina

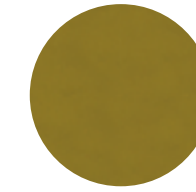

M24
Oliva
Olive
Olive
Olive
Aceituna

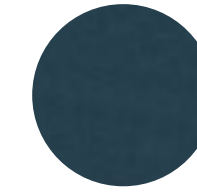

M15
Petrolio
Petrol
Erdoel
Pétrole
Petróleo

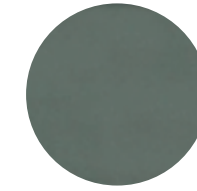

M56
Cadetto
Navy blue
Navy blau
Bleu cadet
Azul marino



M17
Carta da zucchero
Egg blue
Blassblau
Carte de sucre
Celeste



M19
Pervinca
Perwinkle
Hellviolett
Pervenche
Violeta



M23
Rosa
Pink
Rose
Rose
Rosa



M615
Salmone
Salmon
Lachs
Saumon
Salmón



M80
Terracotta
Brick
Ziegel rot
Brique
Ladrillo



M616
Cenere
Ash
Asche
Cendre
Ceniza

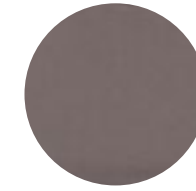

M205
Fumo
Smoke
Rauch
Fumé
Hu



M617
Ardesia
Slate
Schiefer
Ardoise
Pizarra



M16
Avio
Air force blue
Blau-grau
Bleu
Avio



M18
Carbone
Charcoal
Kohle
Charbon
Carbón



Miraglio-T

Composizione
Composition:
100% PL
Solidità alla luce
Light fastness:
≥ 4
Resistenza all'abrasione
Abrasion resistance:
Martindale
≥ 100.000 cicli / cycls

Idrorepellente
Water-repellent



MT130
Cachi
Khaki
Khaki
Kaki
Caqui

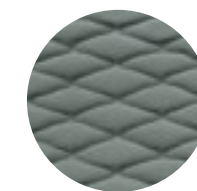

MT56
Cadetto
Navy blue
Navy blau
Bleu cadet
Azul marino

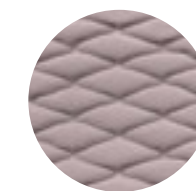

MT19
Pervinca
Perwinkle
Hellviolett
Pervenche
Violeta

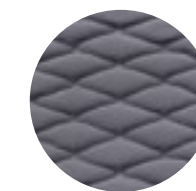

MT617
Ardesia
Slate
Schiefer
Ardoise
Pizarra



MT18
Carbone
Charcoal
Kohle
Charbon
Carbón



Finiture / Finishes

Tessuto / Fabric – Stoff – Tissu – Tejido

Nordwool

Composizione
Composition:
70% WO, 25% PA, 5% AF
Solidità alla luce
Light fastness:
5
Resistenza all'abrasione
Abrasion resistance:
Martindale
≥ 100.000 cicli / cycles



NW802
Verde oliva
Olive green
Olivgrün
Vert olive
Verde aceituna

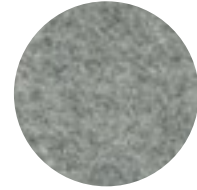

NW600
Grigio chiaro
Light grey
Hell grau
Gris clair
Gris claro



NW200
Grigio scuro
Dark grey
Dunkel grau
Gris foncé
Gris oscuro

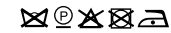

Pelle / Leather – Leder – Cuir – Piel

Pelle rigenerata – Regenerated leather – Regeneriertes leder – Synderme – Piel reconstruida

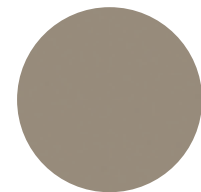

RTO
Tortora
Taupe
Taubengrau
Taupe
Tórtora

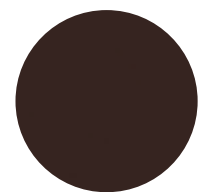

RMT
Testa di moro
Dark brown
Dunkelbraun
Marron
Marrón

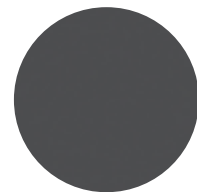

RGR
Grigio
Grey
Grau
Gris
Gris

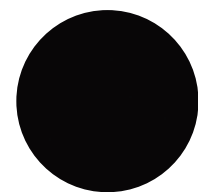

RNE
Nero
Black
Schwarz
Noir
Negro

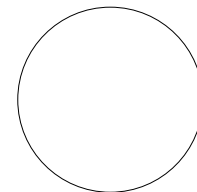

RBI
Bianco
White
Weiß
Blanc
Blanco

Pelle – Leather – Leder – Cuir – Piel

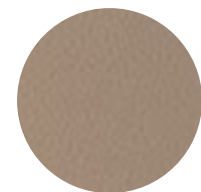

PS
Sabbia
Sand
Sand
Sable
Arena



PC
Caffé
Coffee
Kaffee
Café



PTM
Testa di moro
Dark brown
Dunkelbraun
Marron

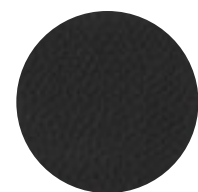

PN
Nero
Black
Schwarz
Noir
Negro

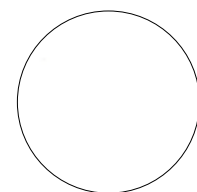

PB
Bianco
White
Weiß
Blanc
Blanco

Finiture / Finishes

Ecopelle

Imitation leather – Kunstleder – Similicuir – Imitación piel

Nobuko

Composizione
Composition:
88% PU, 12% AF
Solidità alla luce
Light fastness:
5
Resistenza all'abrasione
Abrasion resistance:
Martindale
≥ 100.000 cicli / cycles

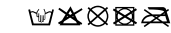

N3
Crema
Cream
Crème
Crème
Crema

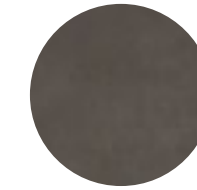

N756
Fango
Mud
Schlammfarbe
Boue
Barro

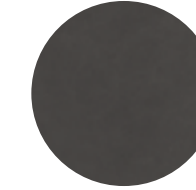

N516
Carbone
Charcoal
Kohle
Charbon
Carbón

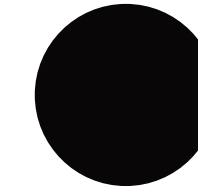

N780
Nero
Black
Schwarz
Noir
Negro

Time

Composizione
Composition:
10% CO - 20% PES - 70% PVC
Solidità alla luce
Light fastness:
4/5
Resistenza all'abrasione
Abrasion resistance:
Martindale
≥ 102.400 secco/dry cicli / cycles
≥ 51.200 umido/wet cicli / cycles



Cl. 11M - IMO - BS7176/EN1021 PARTS 1&2
1994 - BS 5852 (CRIB 5) - TB117:2013

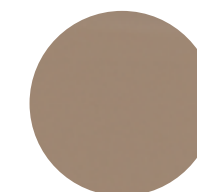
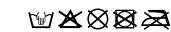

T783
Sabbia
Sand
Sand
Sable
Arena

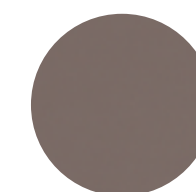

T800
Fango
Mud
Schlammfarbe
Boue
Barro

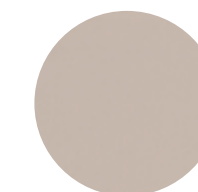

T776
Tortora
Taupe
Taubengrau
Taupe
Tórtora

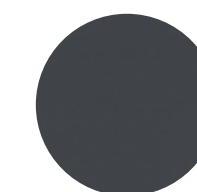

T792
Piombo
Lead
Blei
Plomb
Plomo

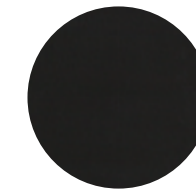

T016
Nero
Black
Schwarz
Noir
Negro

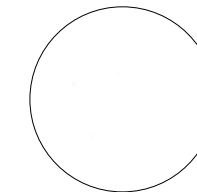

T003
Bianco
White
Weiß
Blanc
Blanco

Bloomm

Composizione
Composition:
15% PL - 85% PVC
Solidità alla luce
Light fastness:
4/5
Resistenza all'abrasione
Abrasion resistance:
Martindale
≥ 50.000 cicli / cycles



B9
Beige
Beige
Beige
Beige
Beige

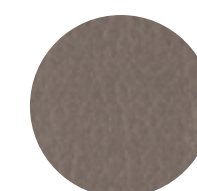

B14
Tortora
Taupe
Taubengrau
Taupe
Tórtora

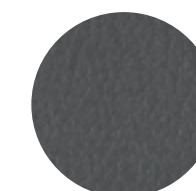

B7
Grigio
Grey
Grau
Gris
Gris

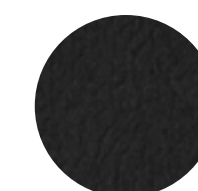

B8
Nero
Black
Schwarz
Noir
Negro

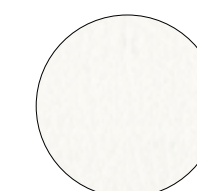

B1
Bianco
White
Weiß
Blanc
Blanco

L'ecopelle, pur della migliore qualità, è un materiale poroso che, a contatto con tessuti o elementi che stingono e a una sudorazione acida, assorbe la colorazione in maniera irreparabile, soprattutto nelle tonalità più chiare.

The imitation leather, even of best quality, has an open grain and when touching easily fading materials and fabrics or acid sweating, it absorbs colours irreparably, especially on light shades.

Das Kunstleder, obwohl aus beste Qualität, ist ein pöroses Material, das neben Bezügen, welche die Farbe verlieren, oder im Fall von Schwitzensäure, die Färbung besonders auf Kunstleder weiß und beige unersetzbar aufnimmt.

Le similicuir, même si de la meilleure qualité, est un matériel poreux, qui, à contact avec des tissus ou des matériaux qui déteignent facilement, ou avec une transpiration acide, absorbe la couleur de façon irréparable, surtout dans les teintes claires.

La imitación piel es un material poroso y, aunque de la mejor calidad, si en contacto con tejidos que descoloron y con una transpiración ácida, absorbe la coloración en manera irreparable, especialmente en las versiones blanco y beige.

Per la pulizia di qualsiasi prodotto raccomandiamo di utilizzare un detergente neutro con un panno morbido inumidito con acqua tiepida. Evitare l'uso di solventi o sostanze acide e abrasive.

We recommend to clean any product with a neutral detergent and damp cloth. Avoid using acid substances, solvents or abrasive products.

Zur Reinigung unserer Artikel empfehlen wir Ihnen, ein mildes Reinigungsmittel und einen mit lauwarmem Wasser befeuchteten Lappen zu verwenden. Ätzende Substanzen, Lösungsmittel, heisse Flüssigkeiten oder aufscheuernde Mittel sind zu vermeiden.

Pour le nettoyage de n'importe quel produit nous recommandons d'utiliser un détergent neutre avec un chiffon moelleux humidifié avec de l'eau tiède. Éviter l'usage de substances acides, de solvants ou de matériels abrasifs.

Para la limpieza de cada producto se recomienda utilizar un detergente neutro con un con un paño humedusito con agua tibia. Evitar solventes o sustancias ácidas y abrasivas.



Le finiture e i rivestimenti dei prodotti sono puramente indicativi per le inevitabili differenze dovute alla riproduzione fotografica e non possono essere fatti oggetto di comparazione con il prodotto finale. Domitalia si riserva il diritto di modificare parzialmente o totalmente la propria produzione senza alcun preavviso e in qualsiasi momento e di apportare migliorie e varianti a suo insindacabile giudizio. Pertanto non vi è obbligo alcuno di rispetto delle finiture o caratteristiche per successive forniture. Invitiamo a consultare il listino allegato per dettagli ed approfondimenti precisi relativamente agli articoli inseriti nel catalogo.

The finishes and the coverings of the products are purely indicative due to the differences that inevitably appear in the photographic reproductions and thus cannot be used as a comparison with the final product. Domitalia reserves the right to partially or fully modify its production at any time without notification and reserves the right to make improvements or variations thereto entirely at its own discretion. Therefore, the company is not obliged to respect finishes and characteristics for the coming supplies. Please refer to the price-list for additional information on the models shown in this catalogue.

Die Endverarbeitungen und Bezüge der Artikel sind aufgrund der unvermeidbaren Unterschiede der fotografischen Abbildung rein bezeichnend und können folglich nicht als Vergleichsobjekt zum Fertigprodukt genommen werden. Domitalia behält sich das Recht vor die eigene Produktion, ohne jegliche Vorwarnung und jederzeit, teilweise oder gänzlich abzuändern und nach eigenem Gutdünken Verbesserungen oder Varianten vorzunehmen. Es besteht daher keine Pflicht die Endverarbeitungen oder Merkmale auch bei den folgenden Lieferungen beizubehalten. Genauere Einzelheiten oder Erklärungen zu den Artikeln unseres Katalogs finden Sie in unserer beigelegten Preisliste.

Les finitions et les revêtements des produits ont un caractère purement indicatif à cause des inévitables différences dues à la reproduction photographique et, par conséquent, ils ne peuvent pas être comparés au produit final. A tout moment et sans avis préalable, Domitalia se réserve le droit de modifier partiellement ou intégralement sa production et, de même, d'apporter des améliorations et des modifications à sa discrétion. Par conséquent, Domitalia n'est pas tenue d'utiliser les mêmes finitions ou de maintenir les mêmes caractéristiques lors des fournitures successives. Nous invitons notre clientèle à consulter le tarif ci-joint pour tout détail et information spécifique concernant les articles présentés dans le catalogue.

Los acabados y revestimientos de los productos son a título puramente indicativo, por las inevitables diferencias debidas a la reproducción fotográfica y, por ende, no pueden ser objeto de comparación con el producto final. Domitalia se reserva el derecho de modificar, parcial o totalmente, su propia producción en cualquier momento y sin ningún aviso previo, así como de aportar mejoras y variantes a su incuestionable juicio. Por lo tanto, no hay obligación alguna de respetar acabados o características para futuros suministros. Para detalles y mayores aclaraciones con respecto a los artículos del catálogo, consultar el listín anexo.

Si raccomanda un'attenzione ed una cura particolare per le sedie con le gambe rivestite in ecopelle, in quanto sono soggette piu' di altre a sporcarsi e graffiarsi se utilizzate in modo non appropriato.

We recommend a special attention and care for the chairs with the legs covered with imitation leather. They are particularly subject, if not properly used, to dirt and scratches.

Für die beine der stühlen mit kunstleder überzogen, empfehlen wir eine besondere aufmerksamkeit und eine spezielle behandlung, da diese stühle auf grund einer unkorrekte benutzung empfindlicher mehr als andere gegen schmutzigkeit und kratzen sind.

Une attention et un soin particulier sont recommandés pour les chaises dont les pieds sont recouverts de similicuir, etant donne qu'elles se salissent et se griffent plus facilement que d'autres si on les utilise d'une facon inappropriée.

Para sillas con patas revestidas en simipiel se recomienda que atención y cuidados especiales como están mas sujetas a sucirse y rayarse si usadas en manera no apropiada.

Domitalia by night / Domitalia by night

Dati tecnici degli articoli con sistemi opzionali di illuminazione

Technical data of the items with optional lighting systems.

Technische Daten des Artikels mit optionalen Beleuchtungssystemen.

Informations techniques des articles avec éclairage optionnel.

Datos técnicos de los modelos con sistemas opcionales de iluminación.



Illuminazione con filo (lampadina non inclusa)

Sistema per cui è necessario provvedere all'installazione di una lampadina a fluorescenza (altezza max della lampadina 110 mm - 20w consigliabili). Protezione ip44.

Lighting with cord (light bulb not included)

A system for which installing a fluorescent light bulb is needed (max height of the light bulb 110 mm - 20w is recommended). Ip44/nema2 rating.

Beleuchtung mit kabel (glühlampe nicht inbegriffen)

System, bei welchem eine glühlampe eingebaut werden muss (maximale höhe der glühlampe 110 mm - 20w empfohlen). Schutzindikator ip 44.

Eclairage avec fil (ampoule non incluse)

Il faut prévoir l'installation d'une ampoule fluorescente (hauteur maximum ampoule 110 mm - 20w conseilles). Protection ip44.

Iluminación con tira (Bombilla no incluida)

Sistema para el cual es necesario instalar una bombilla fluorescente (Altura máx de la bombilla 110 mm - 20w recomendable). Protección ip44.

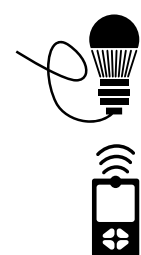

Illuminazione con filo, Lampadina led e telecomando

Sistema provvisto di lampadina a led (9w) e telecomando. Oltre alla possibilità di mantenere fissi tutti i colori disponibili (bianco, rosa, fucsia, rosso, giallo, verde, blu), tramite telecomando si possono regolare: intensità, velocità cambio colore, intermittenza e dissolvenza. Protezione ip44.

Lighting with cord, led light bulb and remote control

A system having a led light bulb (9w) and remote control. Intensity, colour change speed, blinking and fading can be adjusted, in addition of being able to keep all the available colours fixed (white, pink, fuchsia, red, yellow, green, blue), via a remote control. Ip44/nema2 rating.

Beleuchtung mit kabel, led-glühlampe und fernbedienung

System mit led-glühlampe (9w) diengung. Zusätzlich haben sie die möglichkeit, alle verfügbaren farben mit einer fernbedienung dauernd zu halten (weiß, rosa, fucsia, rot, gelb, grün, blau), kann man folgendes einstellen: intensität, geschwindigkeit der farbenänderung, blinken und farbnuanca. Schutzindikator ip 44.T

Eclairage avec fil, ampoule, led et télécommande

Système équipé d'une ampoule led (9w) et télécommande. Ainsi que la possibilité d'avoir tous les couleurs disponibles (blanc, rose, fuchsia, rouge, jaune, vert, bleu), à l'aide de la télécommande il est possible de régler : intensité, vitesse de changement de la couleur, intermittenza et décoloration. Protection ip44.

Iluminación con tira, bombilla led y mando a distancia

Sistema con bombilla de led (9w) y mando a distancia. Además de la posibilidad de mantener fijos todos los colores disponibles (blanco, rosa, fucsia, rojo, amarillo, verde, azul), con mando a distancia pueden ser regulados: intensidad, velocidad de cambio de color, intermittenza y disolvenca. Protección ip44.



Illuminazione senza filo, con led, batteria ricaricabile e telecomando

Sistema a led a risparmio energetico (3,6 w) provvisto di batteria ricaricabile con 8 ore di autonomia. Oltre alla possibilità di mantenere fissi tutti i colori disponibili (bianco, rosa, fucsia, rosso, giallo, verde, blu), tramite telecomando si possono regolare: intensità, velocità cambio colore, intermittenza e dissolvenza. Protezione ip55.

Lighting without cord, with led, rechargeable battery and remote control

Led energy-saving system (3,6 w) with a rechargeable battery with 8 hours of battery life. Intensity, colour change speed, blinking and fading can be adjusted, in addition of being able to keep all the available colours fixed (white, pink, fuchsia, red, yellow, green, blue), via a remote control. Ip55/nema3 rating.

Beleuchtung ohne kabel, mit led-leuchte, wieder aufladbaren akku und fernbedienung

Led-system für einen niedrigen energiekonsum (3,6 w), verfügt über einen wieder aufladbaren akku mit 8 stunden ladedauer. Zusätzlich haben sie die möglichkeit, alle verfügbaren farben mit einer fernbedienung dauernd zu halten (weiß, rosa, fucsia, rot, gelb, grün, blau), kann man folgendes einstellen: intensität, geschwindigkeit der farbenänderung, blinken und farbnuanca. Schutzindikator ip55.

Eclairage sans fil, avec led, batterie rechargeable et télécommande

Système à led à économie d'énergie (3,6 w) équipé de batterie rechargeable avec 8 heures d'autonomie. Ainsi que la possibilité d'avoir tous les couleurs disponibles (blanc, rose, fuchsia, rouge, jaune, vert, bleu), à l'aide de la télécommande il est possible de régler : intensité, vitesse de changement de la couleur, intermittenza et décoloration. Protection ip55.

Iluminación sin hilo, con led, batería recargable y mando a distancia

Sistema de led con ahorro de energía (3.6 W) con batería recargable con 8 horas de autonomía. Además de la posibilidad de mantener fijos todos los colores disponibles (blanco, rosa, fucsia, rojo, amarillo, verde, azul), con mando a distancia pueden ser regulados: intensidad, velocidad de cambio de color, intermittenza y disolvenca. Protección ip55.



Kit di drenaggio

Kit previsto unicamente per la versione in polietilene traslucido provvisto di sistema di illuminazione. Prevedere un vaso ed un sottovaso per evitare di ostruire foro e tubo di drenaggio che devono essere regolarmente controllati e puliti.

Drain kit

A kit provided only for the translucent polyethylene version having a lighting system. Make sure you have a pot and saucer to avoid that the hole and the drain pipe get jammed. They must be regularly checked and cleaned.

Dränage-kit

Kit ausschließlich für die Version aus durchscheinendem polyäthylen mit leuchtungssystem. Anordnung einer vase und einer untervase, um die verstopfung der öffnung und des dränagerohres, welche regelmäßig geprüft und gereinigt werden müssen. Um eine éclairage

Kit de drainage

Kit disponible pour le version en polyéthylène translucide avec système d'éclairage. Prévoir un pot ou un dessous de pot pour éviter d'obstruer le trou et le tuyau de drainage, qui sont à contrôler et nettoyer régulièrement.

Kit de drenaje

Kit previsto solamente para la versión en polietileno traslucido con sistema de iluminación. Es importante utilizar un florero y un platillo para evitar que se obstruya el agujero y el tubo de drenaje que deben ser regularmente controlados y limpiados.

Guida ai simboli

Legend - Bedeutung der Symbole - Guide des symboles - Guía de símbolos

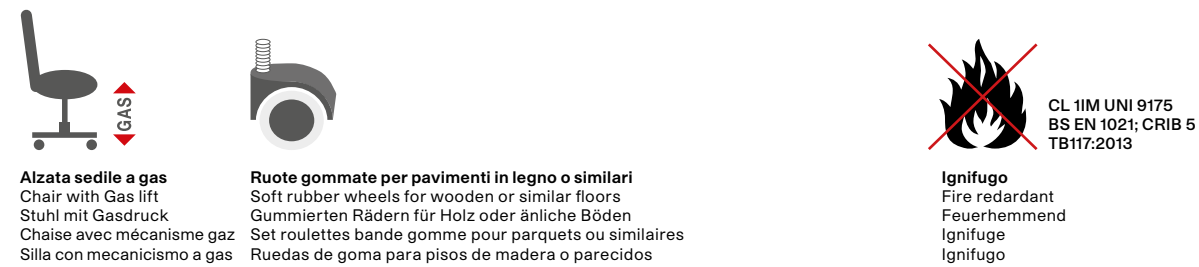
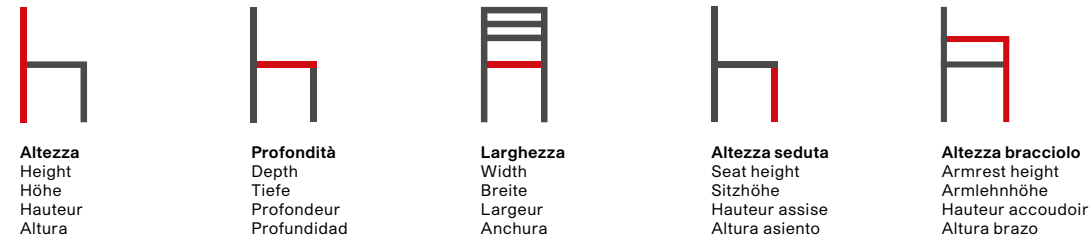

Guida ai simboli

Legend - Bedeutung der Symbole - Guide des symboles - Guía de símbolos

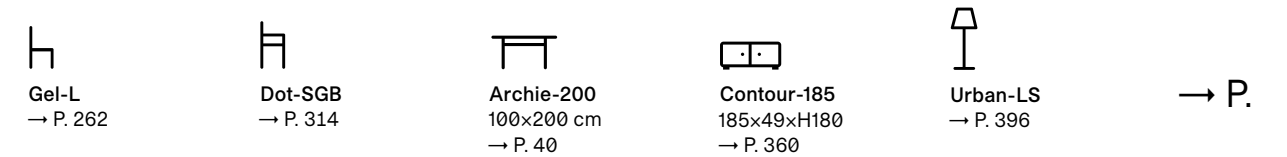
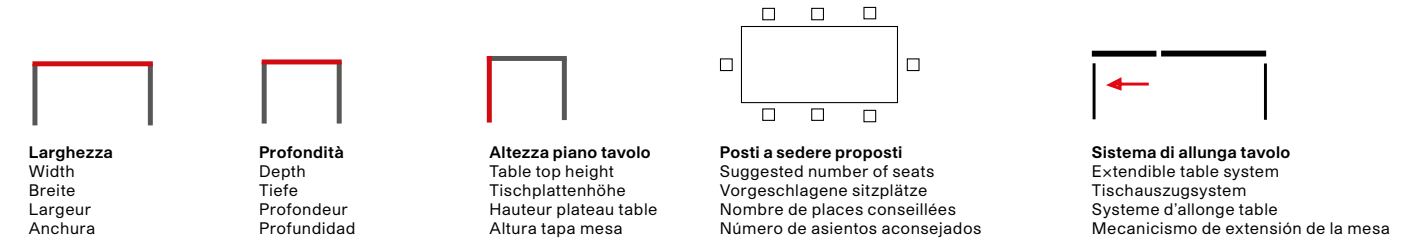

Vedi pag...
See page...
Siehe Seite...
Voir page...
Ver página...

È vietata la riproduzione, anche parziale, di tutte le immagini inserite nel presente catalogo. Le stesse potranno essere utilizzate unicamente previa autorizzazione scritta da parte della DOMI SRL.

It is forbidden to reproduce entirely or partially any image in this catalogue. They may be used only after written authorization of DOMI SRL.

Auch eine teilweise Reproduktion aller im vorliegenden Katalog enthaltenen Bilder ist verboten. Diese dürfen nur nach vorheriger schriftlicher Genehmigung durch DOMI SRL.

La reproduction de n'importe quelle image même si partielle, insérée dans ce catalogue est interdite. Ces images pourront être utilisées uniquement après avoir obtenu une autorisation écrite par DOMI SRL.

Está prohibida la reproducción incluso parcial, de las imágenes presentes en este catálogo. Las mismas se podrán utilizar únicamente previa autorización escrita por parte de DOMI SRL.

Crediti / Credits

Fotografie / Photography

Silvio Salvador

Fotoliti / Colour separation

Litostil

Progetto grafico / Graphic design

Giovanni Di Natale - MAYBE Studio

Stampa / Print

Poligrafiche San Marco - Cormons - Go - IT

Contatti / Contacts

Domi Srl

Via Nazionale, 65

33048 San Giovanni al Natisone - Udine - Italy

T. +39 0432 749411 - F. +39 0432 749495

Export dept. F. +39 0432 749494

info@domitalia.it - www.domitalia.it

Validità / Valid from

Aprile 2018 / April 2018



8 026414 691889