



f  mm y
young



**Uno spazio personale,
un ambiente dedicato al riposo,
allo studio e al gioco, un luogo che rispecchia
la personalità di chi lo vive con soluzioni
innovative, colori e materiali di design
che coniugano progetto, qualità e praticità.
Tommy young, un nuovo modo di
vivere la zona notte giovane**

A personal space, a room devoted to rest, study and play, a place to reflect the personality with innovative solutions and design materials and colours bringing together concept, quality and practicality.
Tommy young, a new way to live the young night area.

Un espacio personal, un ambiente dedicado al descanso, al estudio y al juego, un lugar que refleja la personalidad de quien lo vive con soluciones innovadoras, colores y materiales de diseño que unen proyecto, calidad y practicidad.
Tommy young, un nuevo modo de vivir la zona noche joven.



spazi creativi da comporre con complementi dal design innovativo

Creative spaces to furnish with innovative complementary items.
Espacios creativos para componer con complementos de diseño innovador.

COMPOSIZIONE T19

Foto nelle pagine precedenti e in queste pagine: Letto CORNER sponda alta tessuto Cat. B Art. Texas Col. 12, comodino REPLAY laccato opaco Piombo 129 e laccato opaco Camomilla 139, librerie MOVIDA metallo laccato opaco Piombo 129 con ripiani laccato opaco Bianco gesso 121 e contenitori PEDRO in Beton, SCRITTOIO piano laccato opaco Bianco gesso 121 con gambe DIAGONAL, KALISTA in metallo laccato opaco Camomilla 139, KALISTA MIDI metallo laccato opaco Bianco gesso 121 e laccato opaco Piombo 129, specchio INSIDE con vani a giorno in metallo laccato opaco Piombo 129 e laccato opaco Camomilla 139, sedia TIFFANY YOUNG tessuto Cat. C Art. Linara Col. 16 e cuciture filo 5017, tavolino JOY struttura metallo cromato e piano laccato opaco Camomilla 139, TASCA PARETE in tessuto. / COMPOSIZIONE T19. Photos on the preceding pages and on these: CORNER bed with tall sides covered with fabric Cat. B Texas Art. Col.12. REPLAY bedside unit in matt 129 Lead lacquer and matt 139 Chamomile lacquer. MOVIDA bookcases in matt 129 Lead lacquered metal with matt 121 Chalk white lacquered shelves and PEDRO in Beton finish units. SCRITTOIO with matt 121 Chalk white lacquered top and DIAGONAL legs. KALISTA element in matt 139 Chamomile lacquered metal. KALISTA MIDI unit in matt 121 Chalk white lacquered and matt 129 Lead lacquered metal. INSIDE mirror with open compartments in matt 129 Lead and matt 139 Chamomile lacquered metal. TIFFANY YOUNG chair in fabric Cat.C, Linara Art., Col.16 and 5017 yarn stitching. JOY coffee table with a chromed metal structure and a matt 139 Chamomile lacquered top. Fabric TASCA PARETE. / COMPOSICIÓN T19. Fotografías en las páginas anteriores y en estas páginas: Cama CORNER lateral alto tejido Cat. B Art. Texas Col. 12, mesita de noche REPLAY lacado mate Plomo 129 y lacado mate Manzanilla 139, librerías MOVIDA metal lacado mate Plomo 129 con baldas lacado mate Blanco yeso 121 y contenedores PEDRO en Beton, SCRITTOIO sobre lacado mate Blanco yeso 121 con patas DIAGONAL, KALISTA de metal lacado mate Manzanilla 139, KALISTA MIDI metal lacado mate Blanco yeso 121 y lacado mate Plomo 129, espejo INSIDE con compartimentos abiertos de metal lacado mate Plomo 129 y lacado mate Manzanilla 139, silla TIFFANY YOUNG tejido Cat. C Art. Linara Col. 16 y costuras hilo 5017, mesita JOY estructura metal cromado y sobre lacado mate Manzanilla 139, TASCA PARETE de tejido.

appendere e riporre in totale libertà

Total freedom to hang and put away.
Colgar y guardar con total libertad.



TASCA PARETE sx con fondo in tessuto Cat. B Art. Texas Col. 25 e tasche in tessuto Cat. B Art. Texas Col. 12, TASCA PARETE dx con fondo in tessuto Cat. B Art. Texas Col. 10 e tasche in tessuto Cat. B Art. Texas Col. 31. / TASCA PARETE holdall hung on the wall on the left with Cat. B, Texas Art., Col. 25 basic fabric and pockets in Cat. B, Texas Art., Col. 12 fabric. TASCA PARETE holdall hung on the wall on the right with Cat. B, Texas Art., Col. 10 basic fabric and pockets in Cat. B, Texas Art., Col. 31 fabric. / TASCA PARETE izda. con base de tejido Cat. B Art. Texas Col. 25 y bolsillos de tejido Cat. B Art. Texas Col. 12, TASCA PARETE dcha. con base de tejido Cat. B Art. Texas Col. 10 y bolsillos de tejido Cat. B Art. Texas Col. 31.



una scelta infinita di stile e creatività

Endless stylistic and creative choices.
Una variedad infinita de estilo y creatividad.





complementi d'arredo e contenitori dalle linee essenziali

Minimalist complementary furniture and storage units.

Complementos de mobiliario y contenedores de líneas esenciales.

COMPOSIZIONE T20

Foto nelle pagine precedenti e in queste pagine: Letto BRAVO tessuto Cat. C Art. Gate Col. 019 con cuciture filo 3426 e piedi TONDINO cromato, pensili CIKO in metallo laccato opaco Piombo 129 con schiena in laccato opaco Piombo 129 e rosa fluo, KALISTA PANCA metallo laccato opaco Corallo 133, librerie MOVIDA struttura metallo laccato opaco Bianco gesso 121 con ripiani laccato opaco piacenza 130 e contenitori PEDRO in Beton, SCRITTOIO laccato opaco Grigio Piacenza 130 con gambe SLITTA metallo laccato opaco bianco 121, sedia TIFFANY YOUNG tessuto Cat. B Art. Texas Col. 25 con cuciture filo 0856, tavolino 33 variante 07. / COMPOSIZIONE T20. Photos on the preceding pages and on these: BRAVO bed covered with Cat. C Gate Art. Col. 019 fabric with 3426 yarn stitching and chromed TONDINO legs. CIKO wall units in matt 129 Lead lacquered metal with matt 129 Lead and fluorescent Pink lacquered back panels. KALISTA PANCA in matt 133 Coral lacquered metal. MOVIDA bookcases with matt 121 Chalk white lacquered and matt 130 Piacenza Grey lacquered shelves and PEDRO in Beton finish open units. SCRITTOIO in matt 130 Piacenza Grey lacquer with SLITTA legs in matt 121 white lacquered metal. TIFFANY YOUNG chair in fabric Cat. B, Texas Art., Col. 25 with 0856 yarn stitching. 33 coffee table, option 07. / COMPOSICIÓN T20. Fotografías en las páginas anteriores y en estas páginas: Cama BRAVO tejido Cat. C Art. Gate Col. 019 con costuras hilo 3426 y patas TONDINO cromado, colgantes CIKO de metal lacado mate Plomo 129 con trasera en lacado mate Plomo 129 y rosa fluo, KALISTA PANCA metal lacado mate Corallo 133, librerías MOVIDA estructura metal lacado mate Blanco yeso 121 con baldas lacado mate piacenza 130 y contenedores PEDRO en Beton, SCRITTOIO lacado mate Gris Piacenza 130 con patas SLITTA metal lacado mate blanco 121, silla TIFFANY YOUNG tejido Cat. B Art. Texas Col. 25 con costuras hilo 0856, mesita 33 variante 07.



note di colore accostate ad infinite sfumature di grigio

Bright colours combined with endless shades of grey.
Notas de color junto a infinitas gradaciones de gris.

Armadio 1/ONE ante scorrevoli Materico laccato opaco Bianco gesso con maniglie SIDE laccato opaco Grigio Piacenza 130, particolare SCRITTOIO piano laccato opaco Grigio Piacenza 130 con gambe SLITTA metallo laccato opaco bianco 121, sedia TIFFANY YOUNG tessuto Cat. B Art. Texas Col. 25 con cuciture filo 0856, pensili CIKO in metallo laccato opaco Piombo 129 e laccato opaco Bianco gesso 121 con schiena in laccato opaco Piombo 129 e rosa fluo. / 1/ONE sliding-door wardrobe in Textured matt Chalk white lacquer with SIDE handles in matt 130 Piacenza Grey lacquer. Detail of the SCRITTOIO with its matt 130 Piacenza Grey lacquered top and SLITTA legs in matt 121 white lacquer. TIFFANY YOUNG chair in fabric Cat. B, Texas Art., Col. 25 with 0856 yarn stitching. CIKO wall units in matt 129 Lead and matt 129 Chalk white lacquered metal with matt 129 Lead lacquered and fluorescent Pink back panels. / Armario 1/ONE puertas correderas Texturizado lacado mate Blanco yeso con tiradores SIDE lacado mate Gris Piacenza 130, detalle SCRITTOIO sobre lacado mate Gris Piacenza 130 con patas SLITTA metal lacado mate blanco 121, silla TIFFANY YOUNG tejido Cat. B Art. Texas Col. 25 con costuras hilo 0856, colgantes CIKO de metal lacado mate Plomo 129 y lacado mate Blanco yeso 121 con trasera en lacado mate Plomo 129 y rosa fluo.



ispirazioni per arredare le pareti con stile

Inspiration to stylishly furnish walls.
Inspiraciones para equipar las paredes con estilo.

TASCA FIANCO con fondo in tessuto Cat. B Art. Texas Col. 25 e tasche in tessuto Cat. B Art. Texas 12, particolare letto BRAVO tessuto Cat. C Art. Gate Col. 019 cucitura filo 3426, particolare librerie MOVIDA struttura metallo laccato opaco Bianco gesso 121 con ripiani laccato opaco piacenza 130 e contenitori PEDRO in Beton. / TASCA FIANCO holdall with Cat. B, Texas Art., Col. 25 basic fabric and pockets in Cat. B, Texas Art., Col. 12 fabric. Close-up view of BRAVO bed in fabric Cat. C Gate Art. Col. 019, stitching in 3426 yarn. Close-up view of the MOVIDA bookcase with a matt 121 Chalk white lacquered metal structure and matt 130 Piacenza Grey lacquered shelves. PEDRO in Beton finish open units. / TASCA FIANCO con base de tejido Cat. B Art. Texas Col. 25 y bolsillos de tejido Cat. B Art. Texas 12, detalle cama BRAVO tejido Cat. C Art. Gate Col. 019 costura hilo 3426, detalle librerías MOVIDA estructura metal lacado mate Blanco yeso 121 con baldas lacado mate piacenza 130 y contenedores PEDRO en Beton.



HAVE
A
GOOD
DAY

letto bravo
in tessuto con
cuciture a contrasto

Bravo bed in fabric with contrast stitching.
Cama bravo de tejido con costura en contraste.





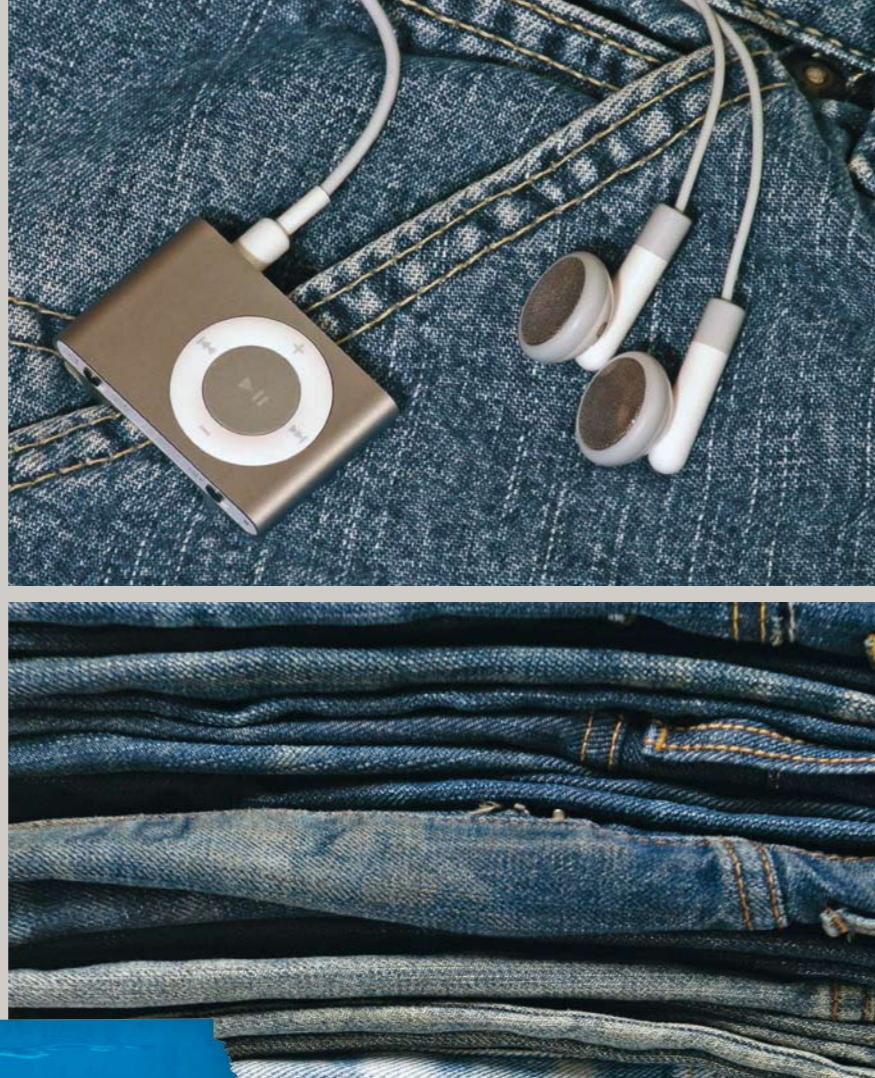

un ambiente da vivere in libertà di giorno e di notte

A room where to feel free, day and night.
Un ambiente que se vive en libertad de día y de noche.

COMPOSIZIONE T15 L. 471 P. 190 H. 255 cm.
Foto nelle pagine precedenti e in queste pagine: Contenitori in laccato opaco Ottanio 172. Librerie in laccato poro aperto Bianco gesso 221 con ante laccato opaco Ottanio 172. Letto BRAVO rivestito in tessuto Cat. C Art. Linara Col. 03 con cuciture filo 0587 con piedi TONDINO. Tavolino ECLISSE laccato opaco Bianco gesso 121 e Ottanio 172. / **COMPOSITION T15**. L. 471 P. 190 H. 255 cm. Photos on the preceding pages and on these: Storage units in matt 172 Teal lacquer. Bookcases in open pore matt 221Chalk white lacquer with doors in matt 172 Teal lacquer. BRAVO bed covered with Cat. C Linara Art. Col. 03 fabric with 0587 yarn stitching and chromed TONDINO legs. ECLISSE coffee table in matt 121 Chalk white and 172 Teal lacquer. / **COMPOSICIÓN T15**. L. 471 P. 190 H. 255 cm. Fotografías en las páginas anteriores y en estas páginas: Contenedores en laccado mate Verde oscuro 172. Librerías en laccado poro abierto Blanco yeso 221 con puertas laccado mate Verde oscuro 172. Cama BRAVO revestida en tejido Cat. C Art. Linara Col. 03 con costuras hilo 0587 con patas TONDINO. Mesita ECLISSE laccado mate Blanco yeso 121 y Verde oscuro 172.



ME
TRO
PO
LI
TAN
STY
LE







amami letto tessile dalle linee morbide, con bottoni applicati.

AMAMI upholstered bed with soft lines and added buttons.

AMAMI cama textil con líneas suaves, con botones aplicados.

COMPOSIZIONE T16 L. 511 P. 300 H. 255 cm.

Foto nelle pagine precedenti e in queste pagine: contenitori e ante in laccato poro aperto Bianco gesso 221. Librerie in laccato opaco Piombo 129 e Camomilla 139. Letto AMAMI rivestito in tessuto Cat. C Art. Linara Col. 13. Tavolino 33 versione 08. Sedia BEVERLY laccato opaco Camomilla 139. KALISTA MIDI e KALISTA PANCA in metallo laccato opaco Bianco gesso 121. / COMPOSIZIONE T16. L. 511 P. 300 H. 255 cm. Photos on the preceding pages and on these: storage units and doors in open pore Bianco gesso 221 Chalk white lacquer. Bookcases in matt 129 Lead and 139 Chamomile lacquer. AMAMI bed in fabric Cat. C Linara Art. Col. 13. 33 coffee table, option 08. BEVERLY chair in matt 139 Chamomile lacquer. KALISTA MIDI unit and KALISTA PANCA in matt 121 Chalk white lacquered metal. / COMPOSICIÓN T16. L. 511 P. 300 H. 255 cm. Fotografías en las páginas anteriores y en estas páginas: contenedores y puertas en laccato poro abierto Bianco yeso 221 Librerías en laccato mate Plomo 129 y Manzanilla 139. Cama AMAMI revestida en tejido Cat. C Art. Linara Col. 13. Mesita 33 versión 08. Silla BEVERLY laccado mate Manzanilla 139. KALISTA MIDI y KALISTA PANCA de metal laccado mate Blanco yeso 121.

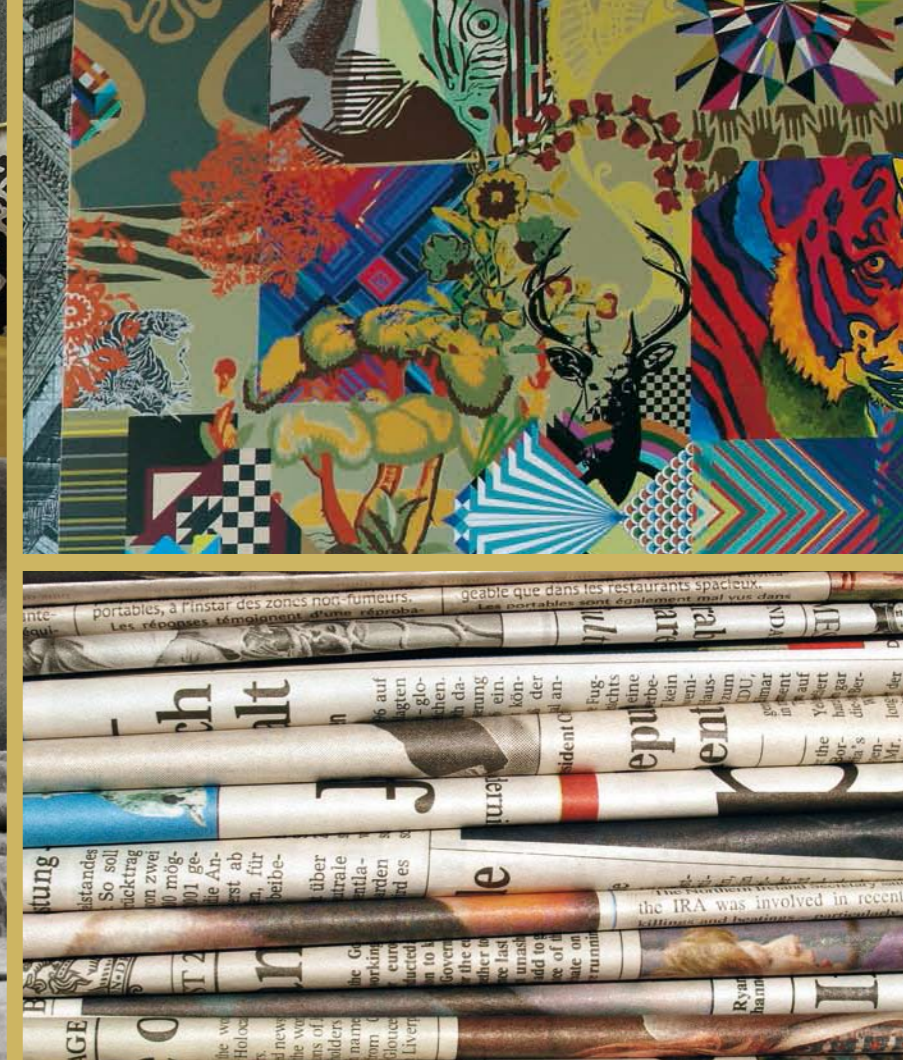

l'importanza e la cura del particolare

The importance and care of detail.
La importancia y los cuidados de los detalles.

Particolare KALISTA PANCA metallo laccato opaco Bianco gesso 121 con cuscino grace 01. / Close-up view of the KALISTA PANCA in matt 121 Chalk white lacquered metal with Grace 01 cushion. / Detalle KALISTA PANCA metal lacado mate Blanco yeso 121 con cojín grace 01.

THE POWER OF COLOR

Scopri
l'energia
del colore

Discover the energy of colour
Descubre la energía del color





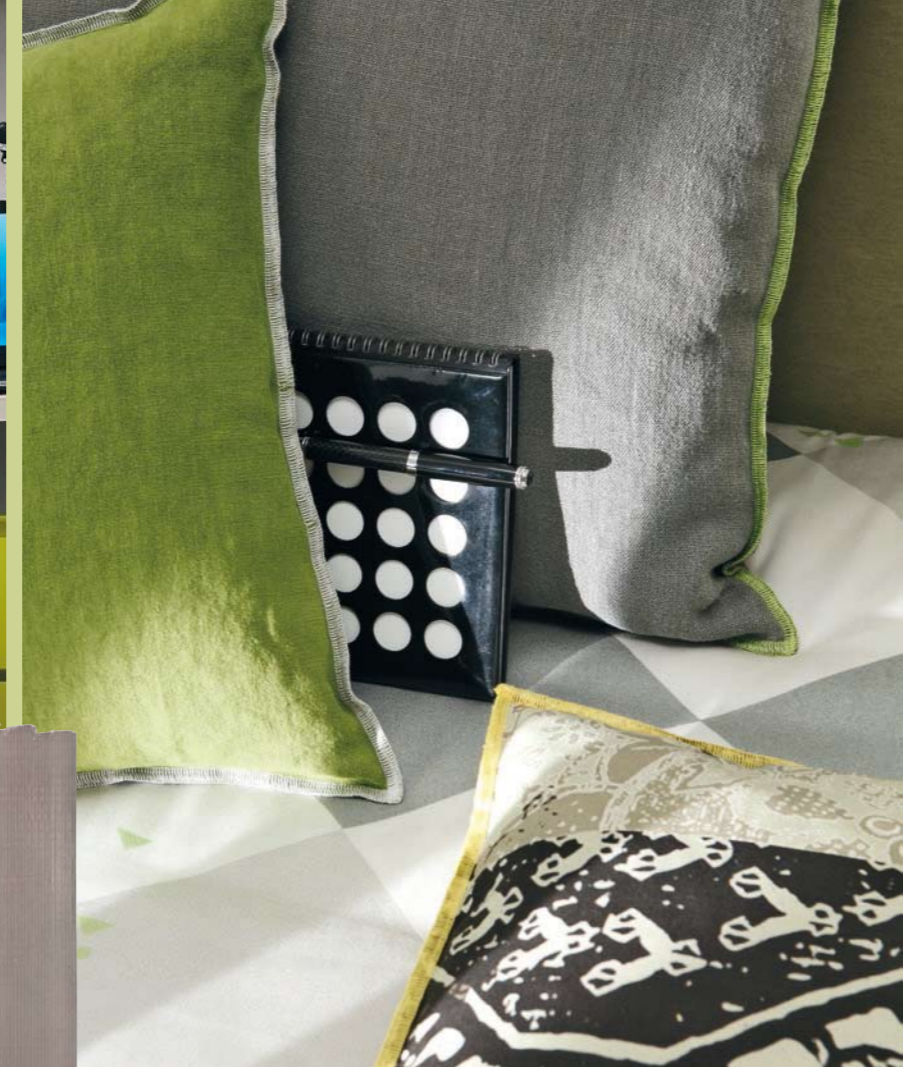

uno spazio su misura per te

A space made just for you.
Un espacio a medida para ti.

COMPOSIZIONE T17 L. 459 P. 315 H. 255 cm.
Foto nelle pagine precedenti e in queste pagine: contenitori e ante in laccato poro aperto Madreperla 224. Librerie in laccato poro aperto Grigio Piacenza 230 con particolari laccato opaco Oliva 147. Letto BRAVO rivestito in ecopelle Cat. B Art. Extrema Col. 12 con cuciture filo 3286. Sedia BEVERLY laccato opaco Grigio Piacenza 130. Piano SCRITTOIO laccato opaco Madreperla 124. Particolare comodino REPLAY laccato opaco Oliva 147. KALISTA FIANCO in metallo laccato opaco Oliva 147. / **COMPOSIZIONE T17**. L. 459 P. 315 H. 255 cm. Photos on the preceding pages and on these: storage units and doors in open pore 224 mother-of-pearl lacquer. Bookcases in open pore 230 Piacenza Grey lacquer with details in matt 147 Olive lacquer. BRAVO bed covered with Cat. B Extrema Art. Col. 12 eco-leather with 3286 yarn stitching. BEVERLY chair in matt 130 Piacenza Grey lacquer. SCRITTOIO top in matt 124 mother-of-pearl lacquer. Detail of the REPLAY bedside unit in matt 147 Olive lacquer. KALISTA FIANCO element in matt 147 Olive lacquered metal. / **COMPOSICIÓN T17**. L. 459 P. 315 H. 255 cm. Fotografías en las páginas anteriores y en estas páginas: contenedores y puertas en laccado poro abierto Madreperla 224. Librerías en laccado poro abierto Gris Piacenza 230 con detalles laccado mate Oliva 147. Cama BRAVO revestida en piel sintética Cat. B Art. Extrema Col. 12 con costuras hilo 3286. Silla BEVERLY laccado mate Gris Piacenza 130. Sobre SCRITTOIO laccado mate Madreperla 124. Detalle mesita REPLAY laccado mate Oliva 147. KALISTA FIANCO de metal laccado mate Oliva 147.



romantica la stanza dalle tonalità pink

Romantic room in Pink shades.

Romántica la habitación de tonalidades Color de rosa.



COMPOSIZIONE T18 L. 396 P. 180 H. 220 cm.

Foto nelle pagine precedenti e in queste pagine: contenitori e ante in laccato opaco Pink 145. Librerie in laccato poro aperto Madreperla 224. Basi a terra laccato poro aperto Grigio Piacenza 230. Letto ROCK rivestito in tessuto Cat. C Art. Linara Col. 31 con vassoio laccato opaco Pink 145. SCRITTOIO in laccato opaco Madreperla 124. Sedia BEVERLY in laccato opaco Grigio Piacenza 130. / COMPOSITION T18. L. 396 P. 180 H. 220 cm. Photos on the preceding pages and on these: storage units and doors in matt 145 Pink lacquer. Bookcases in open pore 224 mother-of-pearl lacquer. Floor-standing base units in open pore 230 Piacenza Grey lacquer. ROCK bed covered with Cat. C Linara Art. Col. 31 fabric with matt 145 Pink tray. SCRITTOIO in matt 124 mother-of-pearl lacquer. BEVERLY chair in matt 130 Piacenza Grey lacquer. / COMPOSICIÓN T18. L. 396 P. 180 H. 220 cm. Fotografías en las páginas anteriores y en estas páginas: contenedores y puertas en lacado mate Color de rosa 145. Librerías en lacado poro abierto Madreperla 224. Muebles bajos de suelo lacado poro abierto Gris Piacenza 230. Cama ROCK revestida en tejido Cat. C Art. Linara Col. 31 con bandeja lacado mate Color de rosa 145. SCRITTOIO en lacado mate Madreperla 124. Silla BEVERLY en lacado mate Gris Piacenza 130.





coordinati dallo stile unico e raffinato

Unique and refined coordinates.
Combinaciones de estilo único y refinado.

COMPOSIZIONE T21

Foto nelle pagine precedenti e in queste pagine: letto AMAMI tessuto Cat. C Art. lino froissè Col. 029 con TASCA tessuto Cat. C Art. Gate Col. 138, comodino ATHENA laccato opaco Piombo 129 con inserto vetro Glicine 346, totem CIAO finitura Beton, schiena laccato opaco Bianco gesso 121, TASCA PARETE fondo tessuto Cat. B Art. Texas Col. 35 con tasche tessuto Cat. B Art. Texas Col. 17, SCRITTOIO laccato opaco Bianco gesso 121 con gambe spillo metallo cromato, sedia TIFFANY YOUNG in tessuto Cat. C Art. Linara Col. 04 con cucitura filo 5017, RASTER sospesi acciaio laccato opaco Pomice 152 con interni laccato opaco Glicine 146 e laccato opaco Pomice 152, divanetto FLOWER tessuto Cat. C Art. Gate Col. 138 e tessuto Cat. C Art. Lino froissè Col. 029 con cuciture filo 2851, tavolino CARUSO laccato opaco Bianco gesso 121. / COMPOSIZIÓN T21. Photos on the preceding pages and on these: AMAMI bed in fabric Cat. C, Froissè linen Art., Col. 029, with pockets in fabric Cat. C, Gate Art., Col. 138. ATHENA bedside unit in matt 129 Lead lacquer with 346 Wisteria glass inserts. Beton finish CIAO "Totem" shelving units with back panels in matt 121 Chalk white lacquer. Wall-hung TASCA PARETE holdall with Cat. B Texas Art. Col. 35 basic fabric and pockets in Cat. B Texas Art. Col. 17 fabric. SCRITTOIO in matt 121 Chalk white lacquer with chromed metal Spillo legs. TIFFANY YOUNG chair in Cat. C, Linara Art., Col. 04 fabric with 5017 yarn stitching. Wall-hung RASTER units in matt 152 Pumice lacquered steel with matt 146 Wisteria and matt 152 Pumice lacquered interiors. FLOWER sofa in fabric Cat. C, Gate Art. Col. 138 and fabric Cat. C Froissè linen Art. Col. 029 with 285 yarn stitching. CARUSO coffee table in matt 121 Chalk white lacquer. / COMPOSICIÓN T21. Fotografías en las páginas anteriores y en estas páginas: cama AMAMI tejido Cat. C Art. lino froissè Col. 029 con bolsillo tejido Cat. C Art. Gate Col. 138, mesita ATHENA lacado mate Plomo 129 con aplicación cristal Glicina 346, librería CIAO acabado Beton, trasera lacado mate Blanco yeso 121, TASCA PARETE de pared base tejido Cat. B Art. Texas Col. 35 con bolsillos tejido Cat. B Art. Texas Col. 17, SCRITTOIO lacado mate Blanco yeso 121 con patas spillo metal cromado, silla TIFFANY YOUNG en tejido Cat. C Art. Linara Col. 04 con costura hilo 5017, RASTER suspendidos acero lacado mate Pómez 152 con interiores lacado mate Glicina 146 y lacado mate Pómez 152, sofá FLOWER tejido Cat. C Art. Gate Col. 138 y tejido Cat. C Art. Lino froissè Col. 029 con costuras hilo 2851, mesita CARUSO lacado mate Blanco yeso 121.

raster contenitori sospesi dal design semplice e rigoroso arredano con fantasia e ricercatezza

The simple, no-nonsense design of the wall-hung RASTER units for imaginative and refined furnishings.
RASTER contenedores suspendidos de diseño simple y riguroso decoran con fantasía y elegancia.

Particolare RASTER sospesi acciaio laccato opaco Pomice 152 con interni laccato opaco Glicine 146 e laccato opaco Pomice 152. / Close-up view of wall-hung RASTER units in matt 152 Pumice lacquered steel with matt 146 Wisteria and matt 152 Pumice lacquered interiors. / Detalle RASTER suspendidos acero lacado mate Pómez 152 con interiores lacado mate Glicina 146 y lacado mate Pómez 152.





COMPOSIZIONE T09 L. 468 P. 202 H. 210 cm.

Contenitori in laccato poro aperto Grigio Piacenza 230. Librerie BIBLO orizzontali in laccato opaco Glicine 146. Letto CORNER con sponda sagomata sx con contenitore, rivestito in tessuto Cat. C Art. Olimpo Col. 7/1. SCRITTOIO laccato opaco Grigio Piacenza 130 con gamba SLITTA acciaio, sedia BEVERLY laccato opaco Glicine 146. / COMPOSIZIONE T09. L. 468 P. 202 H. 210 cm. Storage units in open pore matt 230 Piacenza Grey lacquer. Horizontal BIBLO bookcases in matt 146 Wisteria lacquer. CORNER bed with shaped left-hand side panel and storage base, covered with fabric Cat. C Olimpo Art. Col. 7/1. SCRITTOIO in matt 130 Piacenza Grey lacquer with steel SLITTA leg. BEVERLY chair in matt 146 Wisteria lacquer. / COMPOSICIÓN T09. L. 468 P. 202 H. 210 cm. Contenedores en laccado poro abierto Gris Piacenza 230. Librerías BIBLO horizontales en laccado mate Glicina 146. Cama CORNER con lateral perfilado izda con contenedor, revestida en tejido Cat. C Art. Olimpo Col. 7/1. SCRITTOIO laccado mate Gris Piacenza 130 con pata SLITTA acero, silla BEVERLY laccado mate Glicina 146.



creare e trasformare nuovi spazi

Create and transform new spaces.
Crear y transformar nuevos espacios.

Letto CORNER con sponda sagomata sx con contenitore, rivestito in tessuto Cat. C Art. Olimpo Col. 7/1. / CORNER bed with shaped left-hand side panel and storage base, covered with fabric Cat.C Olimpo Art. Col. 7/1. / Cama CORNER con lateral perfilado izda con contenedor, revestida en tejido Cat. C Art. Olimpo Col. 7/1.



COMPOSIZIONE T03 L. 396 P. 242 H. 256 cm.

Contenitori in laccato poro aperto Piombo 229. Librerie BIBLO orizzontali in laccato opaco Camomilla 139 e in laccato poro aperto Piombo 229. Letto CLUB in ecopelle Cat. B Art. Estrema Col. 01. SCRITTOIO laccato opaco Piombo 129 con gamba SLITTA cromata; sedia BEVERLY laccato opaco Piombo 129. Comodini REPLAY laccato poro aperto Piombo 229 e laccato opaco Camomilla 139. / COMPOSITION T03. L. 396 P. 242 H. 256 cm. Storage units in open pore 229 Lead lacquer. Horizontal BIBLO bookcases in matt 139 Chamomile lacquer and in open pore matt 229 Lead lacquer. CLUB bed in eco-leather Cat. B Art. Estrema Col. 01. SCRITTOIO in matt 129 Lead lacquer with steel SLITTA leg. BEVERLY chair in matt 129 Lead lacquer. REPLAY bedside units in open pore 229 Lead and matt 139 Chamomile lacquer. / COMPOSICIÓN T03. L. 396 P. 242 H. 256 cm. Contenedores en laccado poro abierto Plomo 229. Librerías BIBLO horizontales en laccado mate Manzanilla 139 y en laccado poro abierto Plomo 229. Cama CLUB en piel sintética Cat. B Art. Estrema Col. 01. SCRITTOIO laccado mate Plomo 129 con pata SLITTA cromada, silla BEVERLY laccado mate Plomo 129. Mesitas REPLAY laccado poro abierto Plomo 229 y laccado mate Manzanilla 139.

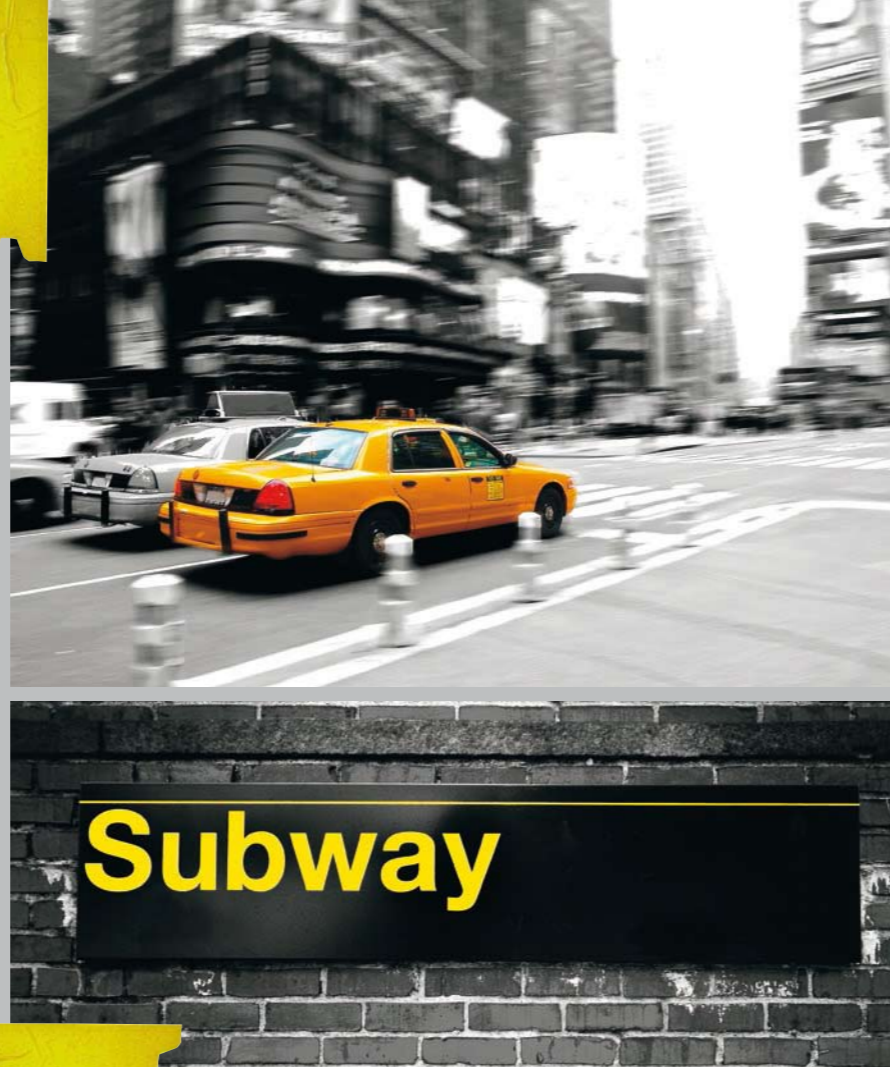

Identità metropolitane in continuo divenire

Metropolitan identities, constantly growing.
Identidades metropolitanas, continuamente cambiantes.

Librerie L. 234 P. 24 H. 252 cm.
Particolare SCRITTOIO laccato opaco Piombo 129 con gamba SLITTA cromata. Librerie BIBLO orizzontali in laccato opaco Camomilla 139 e in laccato poro aperto Piombo 229. / Bookcases L. 234 P. 24 H. 252 cm. Close-up view of the DESK in matt 129 Lead lacquer with steel SLITTA leg. Horizontal BIBLO bookcases in matt 139 Chamomille lacquer and in open pore matt 229 Lead lacquer. / Librerías L. 234 P. 24 H. 252 cm. Detalle ESCRITORIO lacado mate Plomo 129 con pata SLITTA cromada. Librerías BIBLO horizontales en lacado mate Manzanilla 139 y en lacado poro abierto Plomo 229.



FULL
OF
COLORS

letto seven
in ecopelle:
l'energia del colore

SEVEN bed in imitation leather: the energy of colour.
Cama SEVEN en ecopiel: la energía del color.





MAKE THE JUMP!



note vivaci: quando il colore diventa protagonista

Bright notes: when colour steals the show.
Notas alegres: cuando el color se convierte en protagonista.

Foto nelle pagine precedenti e in queste pagine: letto SEVEN in ecopelle Cat. B Art. Extrema Col. 23 con piedi TONDINO, tavolini JOY struttura metallo cromato con piano laccato opaco Camomilla 139 e laccato opaco Piombo 129, pensili RASTER sospesi in metallo laccato opaco Piombo 129. / Photos on the preceding pages and on these: SEVEN bed in eco-leather Cat. B Art. Extrema Col. 23 with tondino legs. JOY coffee tables with a chromed metal structure and matt 139 Chamomile and matt 129 Lead lacquered tops. RASTER wall-hung units in matt 129 Lead lacquered metal. / Fotografías en las páginas anteriores y en estas páginas: cama SEVEN en piel sintética Cat. B Art. Extrema Col. 23 con patas tondino, mesitas JOY estructura metal cromado con sobre lacado mate Manzanilla 139 y lacado mate Plomo 129, colgantes RASTER suspendidos de metal lacado mate Plomo 129.



tessuti grafici e accostamenti tono su tono

Patterned fabrics and tone-on-tone combinations.
Tejidos gráficos y combinaciones tono sobre tono.

Letto PIUMA laccato opaco Bianco gesso 121 con piedi LIGHT e cuscino tessuto Cat. D Art. Bubbles Col. 09, comodini REPLAY laccato opaco Piombo 129 e laccato opaco Camomilla 139, pensili sospesi RASTER acciaio laccato opaco Piombo 129. / PIUMA bed in matt 121 Chalk white lacquer with LIGHT feet and cushions in fabric Cat. D Bubbles Art. Col. 09. REPLAY bedside units in matt 129 Lead and 139 Chamomile lacquer. RASTER wall-hung units in matt 129 Lead lacquered steel. / Cama PIUMA lacada mate Blanco yeso 121 con patas LIGHT y cojin tejido Cat. D Art. Bubbles Col. 09, mesitas REPLAY lacado mate Plomo 129 y lacado mate Manzanilla 139, colgantes suspendidos RASTER acero lacado mate Plomo 129.



bravo dalle linee morbide ma rigorose, rivestito in ecopelle o in tessuto, con cuciture a contrasto

BRAVO with soft but rigorous lines, covered in ecoleather or fabric with contrast stitching.

BRAVO con líneas suaves pero rigurosas, recubierta de ecopiel o de tejido, con costuras en contraste.

Letto BRAVO rivestito in tessuto Cat. C Art. Linara Col. 03 con cuciture filo 0587. Tavolino ECLISSE in metallo laccato opaco Bianco gesso 121 e piano laccato opaco Ottanio 172. KALISTA PANCA metallo laccato opaco Bianco gesso 121 con cuscino Grace 02. Tavolino STRIKE struttura metallo laccato opaco Bianco gesso 121 con piano laccato poro aperto Madreperla 224, shewood, vetro Grigio Piacenza 330 e specchio. / BRAVO bed covered with Cat. C Linara Art. Col. 03 fabric with 0587 yarn stitching. ECLISSE coffee table in matt 121 Chalk white lacquered metal with a matt 172 Teal lacquered top. KALISTA PANCA in matt 121 Chalk white lacquered metal with Grace 02 cushion. STRIKE coffee table with a matt 121 Chalk white lacquered metal structure and open pore 224 mother-of-pearl, shewood, Piacenza Grey glass or mirror top. / Cama BRAVO revestida en tejido Cat. C Art. Linara Col. 03 con costuras hilo 0587. Mesita ECLISSE de metal lacado mate Blanco yeso 121 y sobre lacado mate Verde oscuro 172. KALISTA PANCA metal lacado mate Blanco yeso 121 con cojín Grace 02. Mesita STRIKE estructura metal lacado mate Blanco yeso 121 con sobre lacado poro abierto Madreperla 224, shewood, cristal Gris Piacenza 330 y espejo.





ARE
YOU
CREA
TIVE
?

Estetica e utilizzo moltiplicando il valore dello spazio

Looks and use, increasing the value of the space.
Estética y uso, multiplicando el valor del espacio.



COMPOSIZIONE T04 L. 360 P. 226 H. 212 cm.

Contenitori in laccato poro aperto Bianco-gesso 221. Librerie BIBLO orizzontali, boiserie e comodino su ruote in laccato poro aperto Piombo 229. Letto GINGER rivestito in tessuto Cat. C Art. Lino froissé Col. Jeans 116. Testiera e libreria in laccato poro aperto Piombo 229. / COMPOSIZIÓN T04. L. 360 P. 226 H. 212 cm. Storage units in open pore Bianco yeso 221. Librerías BIBLO horizontales, boiserie y mesita de noche sobre ruedas en laccato poro abierto Plomo 229. Cama GINGER revestida en tejido Cat. C Art. Lino froissé Col. Jeans 116. Cabecero y librería en laccato poro abierto Plomo 229.



sasso rivestito in tessuto o ecopelle, dalle forme tondeggianti e colori vivaci

Sasso, covered in fabric or ecoleather, featuring round lines and bright colours.

Sasso recubierto de tejido o ecopiel, con formas redondeadas y colores vivos.

COMPOSIZIONE T12 L. 396/369 P. 227 H. 255/210 cm.
 Contenitori in laccato poro aperto Madreperla 224. Librerie BIBLO orizzontali in laccato poro aperto Bianco gesso 221. Basi a terra in laccato poro aperto Piombo 229. Letto SASSO rivestito in ecopelle Cat. B Art. Extrema Col. 29. Testiera con cuciture a punto cavallo. SCRITTOIO laccato opaco Bianco gesso 121, sedia BEVERLY laccato opaco Bianco gesso 121, tavolino JOY con struttura cromata, piano laccato opaco Glicine 146. / **COMPOSIZIONE T12.** L. 396/369 P. 227 H. 255/210 cm. Storage units in open pore 224 mother-of-pearl lacquer. Horizontal BIBLO bookcases in open pore 221 Chalk white lacquer. Floor-standing base units in open pore 229 Lead lacquer. SASSO bed in eco-leather Cat. B Art. Extrema Col. 29. Headboard with button-hole stitches. DESK in matt 121 Chalk white lacquer. BEVERLY chair in matt 121 Chalk white lacquer, JOY coffee table with chromed structure and matt 146 Wisteria lacquered top. / **COMPOSICIÓN T12.** L. 396/369 P. 227 H. 255/210 cm. Contenedores en lacado poro abierto Madreperla 224. Librerías BIBLO horizontales en lacado poro abierto Blanco yeso 221. Muebles bajos de suelo en lacado poro abierto Plomo 229. Cama SASSO revestida en piel sintética Cat. B Art. Extrema Col. 29. Cabecero con costuras punto de festón. ESCRITORIO lacado mate Blanco yeso 121, silla BEVERLY lacado mate Blanco yeso 121, mesita JOY con estructura cromada, sobre lacado mate Glicina 146.





Junior suite funzionale ed attrezzata

Junior suite, multifunctional and equipped.
Junior suite, multifuncional y equipada.

SCRITTOIO laccato opaco Bianco gesso 121, sedia BEVERLY laccato opaco Bianco gesso 121. / SCRITTOIO in matt 121 Chalk white lacquer and BEVERLY chair in matt 121 Chalk white lacquer. / SCRITTOIO lacado mate Blanco yeso 121, silla BEVERLY lacado mate Blanco yeso 121.



COMPOSIZIONE T13 L. 324 P. 204 H. 200 cm.

Contenitori in laccato poro aperto Bianco gesso 221. Librerie BIBLO, SCRITTOIO, sedia BEVERLY e tavolino JOY in laccato opaco Celeste 142. Letto SPIRIT laccato opaco Oceano 143 con piedi TONDINO. Comodino su ruote laccato opaco Oceano 143. / COMPOSITION T13. L. 324 P. 204 H. 200 cm. Storage units in open pore Bianco gesso 221 Chalk white lacquer. BIBLO bookcases, SCRITTOIO, BEVERLY chair and JOY coffee table in matt 142 Light blue lacquer. SPIRIT bed in matt 143 Ocean blue lacquer with TONDINO legs. Mobile bedside unit in matt 143 Ocean blue lacquer. / COMPOSICIÓN T13. L. 324 P. 204 H. 200 cm. Contenedores en laccado poro abierto Blanco yeso 221. Librerías BIBLO, SCRITTOIO, silla BEVERLY y mesita JOY en laccado mate Celeste 142. Cama SPIRIT lacada mate Océano 143 con patas TONDINO. Mesita sobre ruedas lacada mate Océano 143.



l'essenzialità dello scrittoio sospeso

The essentiality of the suspended desk.
La esencialidad del escritorio suspendido.

Zona studio L. 288 P. 40/62 H. 200 cm.
Contenitori in laccato poro aperto Bianco gesso 221. SCRITTOIO, sedia BEVERLY e libreria BIBLO orizzontale in laccato opaco Celeste 142. Cassettiera su ruote in laccato opaco Oceano 143. / Study area. L. 288 P. 40/62 H. 200 cm. Storage units in open pore 221 Chalk white lacquer. SCRITTOIO, BEVERLY chair and horizontal BIBLO bookcase in matt 142 Light blue lacquer. Mobile drawer unit in matt 143 Ocean blue lacquer. / Zona estudio. L. 288 P. 40/62 H. 200 cm. Contenedores en lacado poro abierto Blanco yeso 221. SCRITTOIO, silla BEVERLY y librería BIBLO horizontal en lacado mate Celeste 142. Cajonera sobre ruedas en lacado mate Océano 143.



I'M
IN
LO
VE
WI
TH
YOU

Flessibilità in continuo aggiornamento

Flexibility constantly updated.
Flexibilidad continuamente actualizada.

Libreria L. 234 P. 24 H. 180 cm.
Librerie BIBLO orizzontali in laccato opaco Bianco gesso 121 e Oliva 147. / Bookcase L.
234 P. 24 H. 180 cm. BIBLO horizontal bookcases, Olive 147 and Chalk white 121 matt
lacquered. / Libreria L. 234 P. 24 H. 180 cm. Librería BIBLO horizontal de lacado opaco
Bianco yeso 121 y Oliva 147.





COMPOSIZIONE T05 L. 252 P. 204 H. 210 cm Armadio L. 281,2 P. 67,1 H. 255 cm.
 Contenitori in laccato opaco Bianco gesso 121. Librerie BIBLO orizzontali in laccato opaco Bianco gesso 121 e Oliva 147. Letto ORIGAMI in laccato opaco Oliva 147. Armadio LOGICA scorrevole ante 2 settori laccato opaco Bianco gesso 121 con vetro laccato lucido Bianco gesso 321. Tavolino JOY laccato opaco Bianco gesso 121 con struttura cromata. SCRITTOIO laccato opaco Bianco gesso 121. / **COMPOSICIÓN T05**. L. 252 P. 204 H. 210 cm Armario L. 281,2 P. 67,1 H. 255 cm. Contenedores en lacado mate Blanco yeso 121. Librerías BIBLO horizontales en lacado mate Blanco yeso 121 y Oliva 147. Cama ORIGAMI en lacado mate Oliva 147. Armario LOGICA corredero puertas 2 sectores lacado mate Blanco yeso 121 con cristal lacado brillante Blanco yeso 321. Mesita JOY lacado mate Blanco yeso 121 con estructura cromada. SCRITTOIO lacado mate Blanco yeso 121.



Flessibili geometrie multicolore

Flexible multicolour shapes.
Flexibles geometrías multicolores.

Libreria L. 180 P. 24 H. 180 cm.
Librerie BIBLO orizzontali in laccato opaco Bianco gesso 121 e Oliva 147. / Bookcase L. 180 P. 24 H. 180 cm. BIBLO horizontal bookcases, Olive 147 and Chalk white 121 matt lacquered. / Librerías L. 180 P. 24 H. 180 cm. Librerías BIBLO horizontal de lacado opaco Blanco yeso 121 y Oliva 147.



linearità e semplicità incontrano l'eleganza del bianco

Linearity and simplicity meet the elegance of white.
Linealidad y sencillez encuentran la elegancia del blanco.

COMPOSIZIONE T08 L. 360 P. 216 H. 200 cm.

Contenitori in laccato opaco Bianco gesso 121. Librerie BIBLO orizzontali e letto CLIO in poro aperto Piombo 229. SCRITTOIO in laccato poro aperto Piombo 229 con gambe spillo e raccordo per cassetiera in metacrilato. Sedia BEVERLY in laccato opaco Bianco gesso 121, tavolino JOY struttura cromato e piano laccato opaco Oliva 147. / COMPOSICIÓN T08. L. 360 P. 216 H. 200 cm. Storage units in matt 121 Chalk white lacquer. BIBLO horizontal bookcases and CLIO bed in open pore 229 Lead lacquer. SCRITTOIO in open pore 229 Lead lacquer with Spillo legs and methacrylate connecting element for drawer unit. BEVERLY chair in matt 121 Chalk white lacquer, JOY coffee table with chromed structure and matt 147 Olive lacquered top. / COMPOSICIÓN T08. L. 360 P. 216 H. 200 cm. Contenedores en lacado mate Blanco yeso 121. Librerías BIBLO horizontales y cama CLIO en poro abierto Plomo 229. SCRITTOIO en lacado poro abierto Plomo 229 con patas spillo y conexión para cajonera en metacrilato. Silla BEVERLY en lacado mate Blanco yeso 121, mesita JOY estructura cromada y sobre lacado mate Oliva 147.



WE
LO
VE
ALL
CO
LO
RS

Il mondo
in una
stanza

The world in a room.
El mundo en una habitación.





COMPOSIZIONE T06 L. 446 P. 313 H. 255 cm.

Armadio a ponte e cabina in laccato poro aperto Bianco gesso 221. Libreria scorrevole, terminale libreria e pensili passanti ENERGY in laccato poro aperto Piombo 229. Schienale sottoponte e mensola in laccato opaco Celeste 142. Letto CORNER sponda alta rivestito in tessuto Cat. C Art. Lino froissé Col. Jeans 116. / COMPOSIZIONE T06. L. 446 P. 313 H. 255 cm. Bridging wardrobe and walk-in-closet in open pore 221 Chalk white lacquer. Bookcase with sliding door, end bookcase element and ENERGY wall units without sides in open pore 229 Lead lacquer. Back panel below bridging unit and shelf in matt 142 Light blue lacquer. CORNER bed with tall side panel covered with fabric Cat. C Froissé linen Art. Col. Jeans 116. / COMPOSICIÓN T06. L. 446 P. 313 H. 255 cm. Armario puente y cabina en laccado poro abierto Blanco yeso 221. Librería corredera, terminal librería y colgantes pasantes ENERGY en laccado poro abierto Piombo 229. Trasera bajo puente y estante en laccado mate Celeste 142. Cama CORNER lateral alto revestido en tejido Cat. C Art. Lino froissé Col. Jeans 116.



Nuovi spazi sempre più flessibili

New and increasingly flexible spaces.
Nuevos espacios cada vez más flexibles.

Luogo di studio e di gioco, palcoscenico delle relazioni con gli amici, rifugio esclusivo a cui non sono ammessi gli adulti. Le nuove camere **tommy young** hanno mobili e arredi all'insegna della funzionalità assoluta e sono la carta vincente per creare tanti spazi capaci di seguire le varie fasi della giornata. Soluzioni trasformiste e salvaspazio, ideali per limitare ingombri o facilitare la convivenza di età ed esigenze differenti. Sicurezza e solidità di forme e materiali si sposano con creatività e fantasia, per dar vita a progetti e composizioni che i ragazzi possano vivere e modificare secondo il proprio gusto. / A place for study and play, for being with friends, an exclusive retreat where grown-ups are not allowed. The new TOMMY YOUNG bedroom suites have furniture and furnishings under the banner of absolute functionality and are the trump card for creating lots of spaces to suit the various times of the day. Transforming and space-saving solutions, ideal for avoiding cluttering or for facilitating being together and for different needs. Safety and solidity of shapes and materials go hand in hand with creativity and imagination, for projects and compositions that young people can enjoy and change according to taste. / Lugar de estudio y de juego, escenario de las relaciones con los amigos, refugio exclusivo al que los adultos no están admitidos. Los nuevos dormitorios TOMMY YOUNG tienen muebles y elementos decorativos caracterizados por una total funcionalidad y perfectamente adecuados para crear muchos espacios capaces de seguir las diferentes fases de la jornada. Soluciones transformistas y salva-espacio, ideales para limitar el desorden o facilitar la convivencia de edades y exigencias diferentes. Seguridad y solidez de formas y materiales se unen a creatividad e imaginación, para dar vida a proyectos y composiciones que los muchachos puedan utilizar y modificar según sus gustos.





**Non solo notte,
dallo studio
al riposo**

Not only night, from study to rest.
No sólo noche, del estudio al descanso.

**SL
EE
EP
IN
THE
BL
UE**



COMPOSIZIONE T14. L. 422,3 P. 312,4 H. 255 cm.

Contenitori e armadio in laccato opaco Bianco gesso 121. Librerie BIBLO orizzontali e libreria scorrevole per cabina in laccato opaco Celeste 142. Sedia BEVERLY in laccato opaco Celeste 142. Sponda alta rivestito in tessuto Cat. C Art. Olimpo Col. 15/1. SCRITTOIO laccato opaco Bianco gesso 121 con raccordo per cassetiera in metacrilato, sedia BEVERLY laccato opaco Celeste 142. / COMPOSIZIONE T14. L. 422,3 P. 312,4 H. 255 cm. Storage units and wardrobe in matt 121 Chalk white lacquer. Horizontal BIBLO bookcases and bookcase with sliding door for walk-in-closet in matt 142 Light blue lacquer. CORNER bed with tall side panel covered with fabric Cat. C Olimpo Art. Col. 15/1. SCRITTOIO in matt 121 Chalk white lacquer with connecting element for methacrylate drawer unit. BEVERLY chair in matt 142 sky blue lacquer. / COMPOSICIÓN T14. L. 422,3 P. 312,4 H. 255 cm. Contenedores y armario en laccado mate Blanco yéso 121. Librerías BIBLO horizontales y librería corredera para cabina en laccado mate Celeste 142. Cama CORNER lateral alto revestido en tejido Cat. C Art. Olimpo Col. 15/1. SCRITTOIO laccado mate Blanco yéso 121 con conexión para cajonera en metacrilato, silla BEVERLY laccado mate Celeste 142.

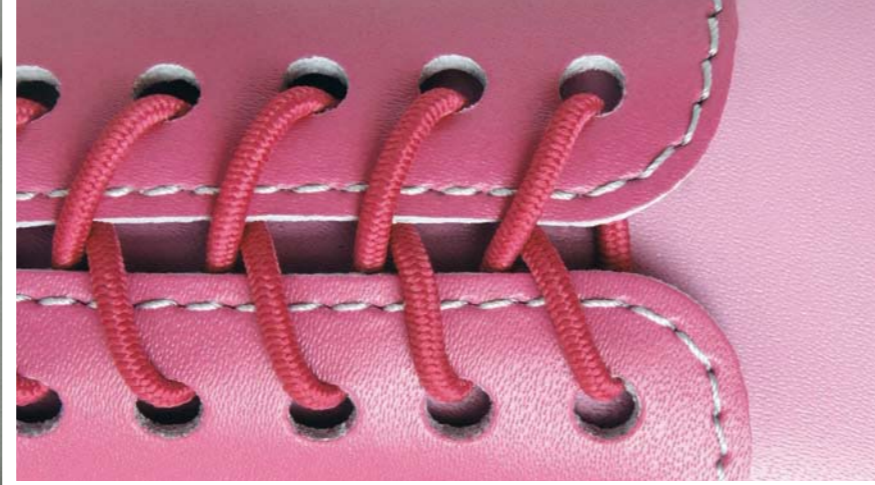

dettagli ad altissima definizione

Very high definition details.
Detalles de altísima definición.



COMPOSIZIONE T01 L. 422 P. 343 H. 255 cm.
Contenitori e armadio in laccato poro aperto Madreperla 224. Librerie BIBLO orizzontali e libreria scorrevole per cabina in laccato opaco Pink 145. Letto GINGER rivestito in tessuto Cat. C Art. Olimpo Col. 20/1. Testiera e libreria in laccato poro aperto Madreperla 224. SCRITTOIO laccato opaco Madreperla 124 con gamba spillo cromato, sedia BEVERLY laccato opaco Pink 145. / COMPOSITION T01. L. 422 P. 343 H. 255 cm. Storage unit and wardrobe in open pore 224 mother-of-pearl lacquer. Horizontal BIBLO bookcases and bookcase with sliding door for walk-in-closet in matt 145 Pink lacquer. GINGER bed covered with Cat. C fabric, Olimpo Art., Col. 20/1. Headboard and bookcase in open pore 224 mother-of-pearl lacquer. SCRITTOIO in matt 124 mother-of-pearl lacquer with steel Spillo leg. BEVERLY chair in matt 145 Pink lacquer. / COMPOSICIÓN T01. L. 422 P. 343 H. 255 cm. Contenedores y armario en lacado poro abierto Madreperla 224. Librerías BIBLO horizontales y librería corredera para cabina en lacado mate Color de rosa 145. Cama GINGER revestida en tejido Cat. C Art. Olimpo Col. 20/1. Cabecero y librería en lacado poro abierto Madreperla 224. SCRITTOIO lacado mate Madreperla 124 con pata spillo cromada, silla BEVERLY en lacado mate Color de rosa 145.



Un solo movimento per scoprire nuovi spazi

Just one action to discover new spaces.

Un solo movimiento para descubrir nuevos espacios.

Perfetto connubio tra estetica e funzionalità per un programma completo e versatile, arricchito da tanti complementi. Include librerie scorrevoli, angoli per l'home office e l'armadio vero e proprio con ripiani e accessori di grande libertà stilistica con concetti salvaspazio di nuova generazione. / A perfect combination of looks and functionality for a complete and versatile programme, enhanced with lots of complementary pieces. It includes sliding bookcases, corner units for the home office and the actual cupboard with shelves and accessories featuring great stylist freedom with new generation space-saving concepts. / Perfecta unión entre estética y funcionalidad para un programa completo y versátil, enriquecido con muchos complementos. Incluye librerías corredizas, rincones para el home office y un verdadero armario con baldas y accesorios de gran libertad estilística con conceptos guarda-espacio de nueva generación.





COMPOSIZIONE T07 L. 252 P. 217 H. 255 cm. Armadio L. 204,5 P. 62,3 H. 255 cm.
 Contenitori e armadio in laccato poro aperto Bianco gesso 221. Librerie BIBLO orizzontali in laccato opaco Pink 145. Letto ROCK dx rivestito in ecopelle Cat. B Art. Extrema Col. lilla 09. / **COMPOSIZION T07**. L. 252 P. 217 H. 255 cm. Wardrobe L. 204,5 P. 62,3 H. 255 cm. Storage units and wardrobe in open pore 221 Chalk white lacquer. Horizontal BIBLO bookcases in matt 145 Pink lacquer. ROCK right-hand bed, covered with Cat. B Art. Extrema Art. Col. 09 lilac eco-leather. / **COMPOSICIÓN T07**. L. 252 P. 217 H. 255 cm. Armario L. 204,5 P. 62,3 H. 255 cm. Contenedores y armario en laccado poro abierto Blanco yeso 221. Librerías BIBLO horizontales en laccado mate Color de rosa 145. Cama ROCK dcha. revestida en piel sintética Cat. B Art. Extrema Col. 09 lila.

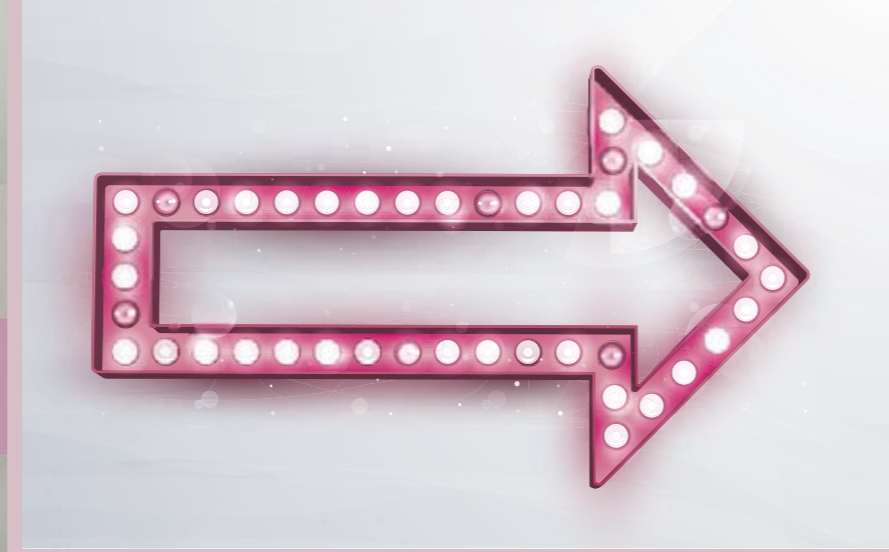

Un posto per ogni cosa

A place for everything.
Un sitio para cada cosa.

Contenitori in laccato poro aperto Bianco gesso 221. Librerie BIBLO orizzontali in laccato opaco Pink 145. / Storage units in open pore 221 Chalk white lacquer. Horizontal BIBLO bookcases in matt 145 Pink lacquer. / Contenedores en lacado poro abierto Blanco yeso 221. Librerías BIBLO horizontales en lacado mate Color de rosa 145.



COMPOSIZIONE T02 L. 396 P. 204 H. 200 cm.

Contenitori in laccato opaco Rosso 134, Corallo 133 e Arancio 148, librerie BIBLO orizzontali e SCRITTOIO con fianco legno in laccato poro aperto Piombo 229, letto ORIGAMI laccato opaco Rosso 134 con piedi RAMO, tavolino JOY struttura cromata con piano laccato opaco Rosso 134, sedia BEVERLY laccato opaco Piombo 129. / COMPOSITION T02. L. 396 P. 204 H. 200 cm. Storage units in matt 134 red, 133 Coral and 148 Orange lacquer. Horizontal BIBLO bookcases and SCRITTOIO with wooden side panel in open pore 229 Lead lacquer. ORIGAMI bed in matt 134 red lacquer with RAMO legs. JOY coffee table, chromed structure with matt 134 Red lacquered top. BEVERLY chair in matt 129 Lead lacquer. / COMPOSICIÓN T02. L. 396 P. 204 H. 200 cm. Contenidores en laccado mate rojo 134, Coral 133 y Naranja 148, librerías BIBLO horizontales y SCRITTOIO con costado madera en laccado poro abierto Plomo 229, cama ORIGAMI laccado mate rojo 134 con patas RAMO, mesita JOY estructura cromada con sobre laccado mate Rojo 134, silla BEVERLY laccado mate Plomo 129.



geometrie per un istinto estetico

Shapes for an aesthetic instinct.
Geometrías para un instinto estético.



VITA MINIC STY LE

progetti in
crescita per
spazi misurati

Growing projects for limited spaces.
Proyectos que crecen para espacios reducidos.





COMPOSIZIONE T11 L. 495/337 P. 228 H. 255 cm.

Contenitori e armadio in laccato poro aperto Bianco gesso 221. Librerie BIBLO orizzontali in laccato opaco Arancio 148 Letto CLUB rivestito in ecopelle Cat. B Art. Extrema Col. 13. SCRITTOIO con fianco legno laccato opaco Bianco gesso 121 e sedia BEVERLY laccato opaco Arancio 148. / COMPOSIZIONE T11, L. 495/337 P. 228 H. 255 cm. Storage units and wardrobe in open pore Bianco gesso 221. Horizontal BIBLO bookcases in matt 148 Orange lacquer. CLUB bed covered with eco-leather Cat. B, Extrema Art., Col. 13. SCRITTOIO with wooden side panel in matt 121 Chalk white lacquer and BEVERLY chair in matt 148 Orange lacquer. / COMPOSICIÓN T11. L. 495/337 P. 228 H. 255 cm. Contenedores y armario en lacado poro abierto Blanco yeso 221. Librerías BIBLO horizontales en lacado mate Naranja 148 Cama CLUB revestida en piel sintética Cat. B Art. Extrema Col. 13. SCRITTOIO con costado madera lacado mate Blanco yeso 121 y silla BEVERLY en lacado mate Naranja 148.



COMPOSIZIONE T10 L. 312,4/446 P. 232 H. 255 cm.

Armadio e cabina con anta scorrevole in laccato poro aperto Madreperla 224. Contenitori e libreria BIBLO orizzontale in laccato poro aperto Grigio Piacenza 230. Mensole per boiserie e tavolino JOY in laccato opaco Rosso 134. Letto CLUB rivestito in ecopelle Cat. B Art. Extrema Col. 01. Pannelli boiserie laccato poro aperto Madreperla 224. SCRITTOIO laccato opaco Madreperla 124 con gamba spillo cromata, sedia BEVERLY laccato opaco Rosso 134. / COMPOSICIÓN T10. L. 312,4/446 P. 232 H. 255 cm. Wardrobe and walk-in-closet with sliding door in open pore 224 mother-of-pearl lacquer. Storage units and horizontal BIBLO bookcases in open pore 230 Piacenza Grey lacquer. Wall panelling shelves and JOY coffee table in matt 134 red lacquer. CLUB bed in eco-leather Cat. B Extrema Art. Col. 01. Wall panels in open pore 224 mother-of-pearl lacquer. SCRITTOIO in matt 124 mother-of-pearl lacquer with steel Spillo leg. BEVERLY chair in matt 134 Red lacquer. / COMPOSICIÓN T10. L. 312,4/446 P. 232 H. 255 cm. Armario y cabina con puerta corredera en laccado poro abierto Madreperla 224. Contenedores y librería BIBLO horizontal en laccado poro abierto Gris Piacenza 230. Estantes para boiserie y mesita JOY en laccado mate rojo 134. Cama CLUB revestida en piel sintética Cat. B Art. Extrema Col. 01. Paneles boiserie en laccado poro abierto Madreperla 224. SCRITTOIO laccado mate Madreperla 124 con pata spillo cromada, sillas BEVERLY laccado mate Rojo 134.



soluzioni versatili per una libertà totale

Versatile solutions for total freedom.
Soluciones versátiles para una libertad total.





una morbida sensazione materica

A soft material feeling.
Una suave sensación matérica.

Letto FEEL rivestito in tessuto Cat. C Art. Olimpo Col. 13/1. Librerie BIBLO orizzontali in laccato opaco Bianco gesso 121. Tavolini JOY Ø 45 in laccato opaco Celeste 142. Tavolino JOY Ø 60 in laccato opaco Bianco gesso 121. / FEEL bed covered with fabric Cat.C Olimpo Art. Col. 13/1. Horizontal BIBLO bookcases in matt 121 Chalk white lacquer. JOY coffee table Ø 45 in matt 142 Light blue lacquer. JOY coffee table Ø 60 in matt 121 Chalk white lacquer. / Cama FEEL revestida en tejido Cat. C Art. Olimpo Col. 13/1. Librerías BIBLO horizontales en lacado mate Blanco yeso 121. Mesitas JOY Ø 45 en lacado mate Celeste 142. Mesita JOY Ø 60 en lacado mate Blanco yeso 121.



COM PO SI ZIO NI

**soluzioni flessibili
e attuali per ogni
esigenza di spazio**

Flexible and trendy solutions for every space requirement.
Soluciones flexibles y actuales por cada exigencia de espacio.



**we
project
/ your
dreams**



FOTO COMPOSIZIONE T18
L. 396 P. 312,4 H. 220 cm.

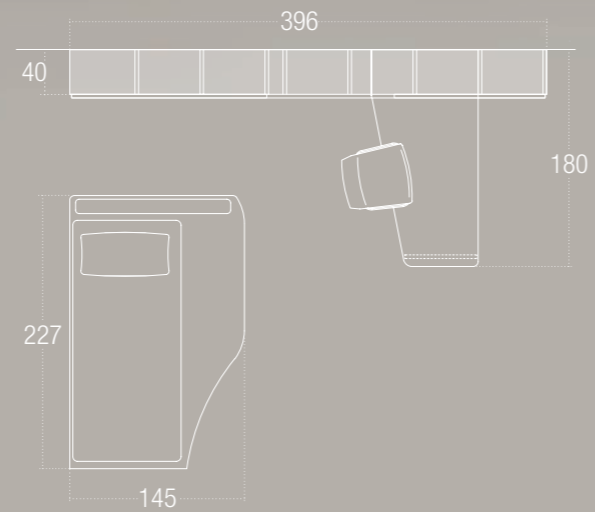

PROPOSTA COMPOSIZIONE T118
L. 350 P. 296,4 H. 220 cm.



FOTO COMPOSIZIONE T15
L. 471 P. 220 H. 255 cm.



PROPOSTA COMPOSIZIONE T115
L. 327 P. 220 H. 255 cm.



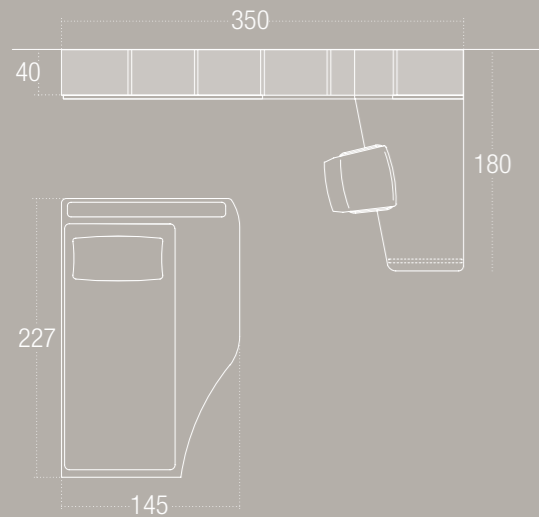
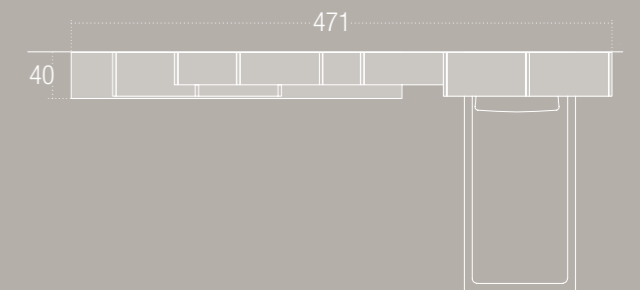

FOTO COMPOSIZIONE T17
L. 459 P. 316 H. 255 cm.



PROPOSTA COMPOSIZIONE T117
L. 405 P. 285 H. 255 cm.

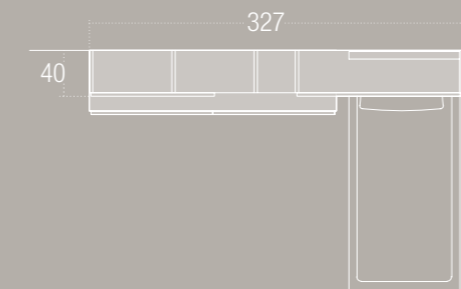
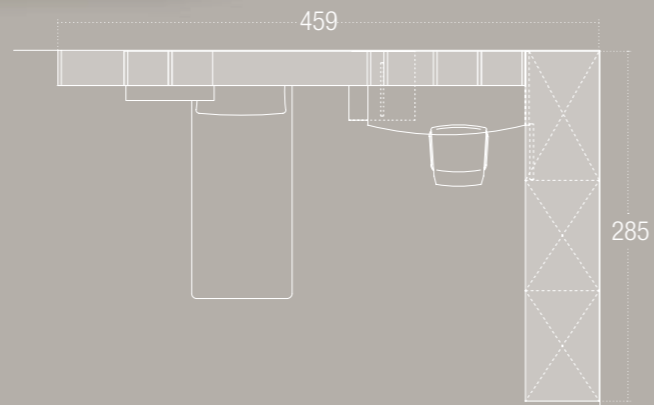

FOTO COMPOSIZIONE T09
L. 468 P. 202 H. 210 cm.



PROPOSTA COMPOSIZIONE T109
L. 396 P. 202 H. 210 cm.



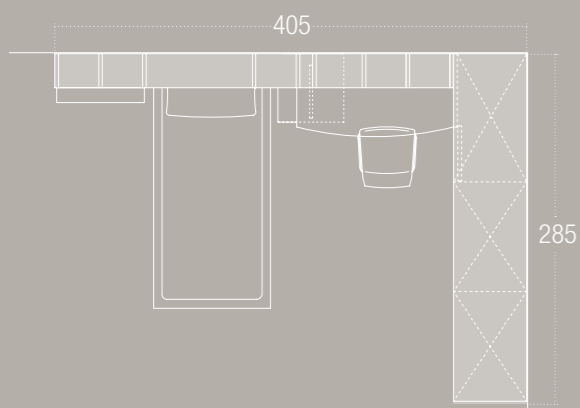
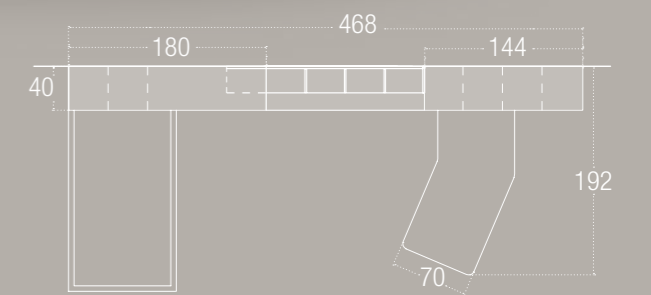

FOTO COMPOSIZIONE T14
L. 422,3 P. 312,4 H. 255 cm.



PROPOSTA COMPOSIZIONE T114
L. 350,3 P. 296,4 H. 255 cm.

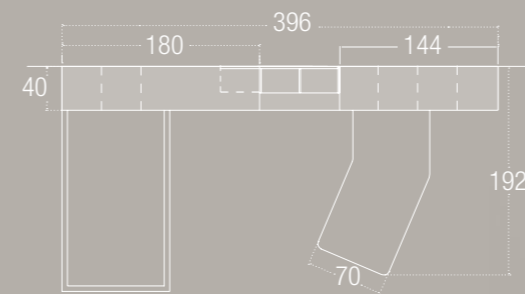
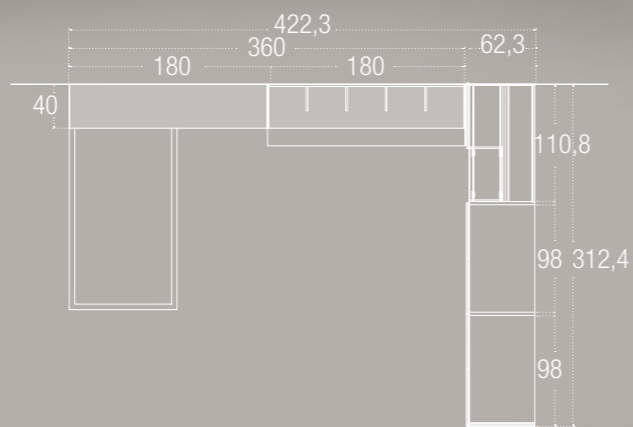

FOTO COMPOSIZIONE T02
L. 396 P. 204 H. 200 cm.



PROPOSTA COMPOSIZIONE T102
L. 324 P. 204 H. 200 cm.



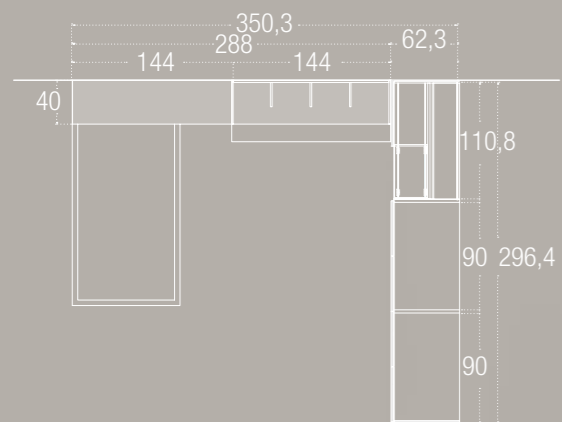
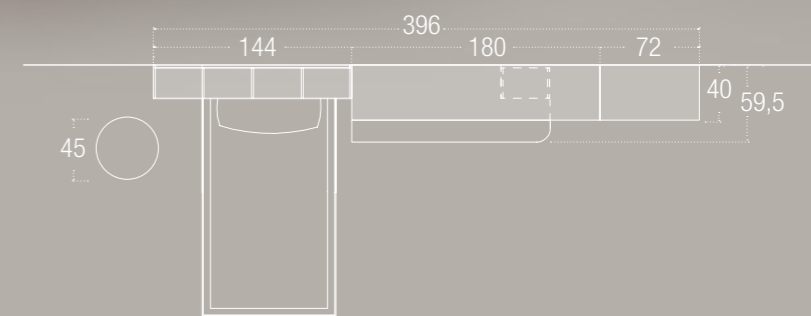

FOTO COMPOSIZIONE T04
L. 360 P. 226 H. 212 cm.



PROPOSTA COMPOSIZIONE T104
L. 276 P. 226 H. 212 cm.

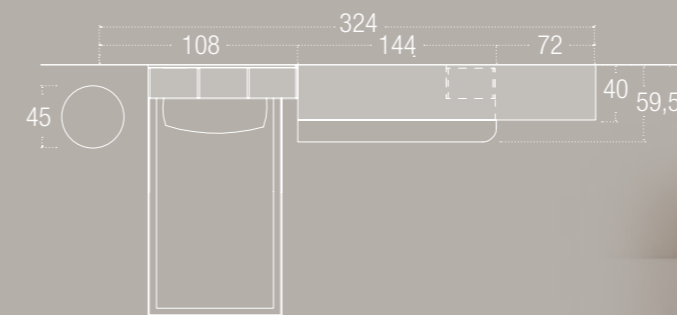
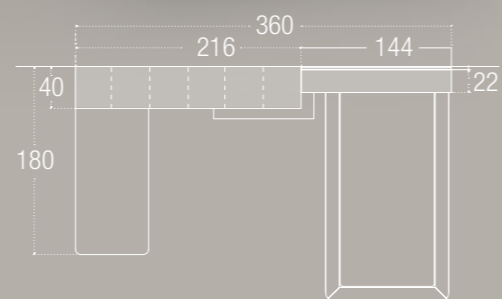

FOTO COMPOSIZIONE T08
L. 360 P. 216 H. 200 cm.



PROPOSTA COMPOSIZIONE T108
L. 288 P. 216 H. 200 cm.



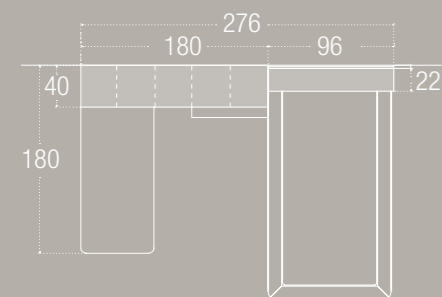
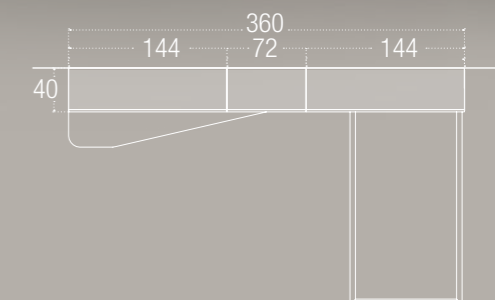
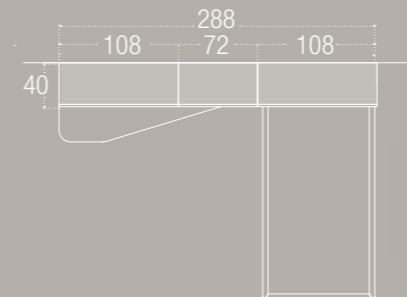

Letti Pg. 132
/Beds /Camas

Spirit
Origami
Ginger
Clio
Bravo
Amami
Seven
Piuma
Sasso
Rock
Club
Feel
Joker
Narciso
Nuvola
Sistema Corner

Complementi Pg. 142
/Complements/Complementos

33
Caruso
Eclisse
Joy
Joy Decor
Cookie
Ciko
Movida
Raster
Ciao
Tasca
Kalista
Inside

Sedie e Scrivtoi Pg. 152
/Chairs and Desks /Sillas y Escritorios

Tipologie Gambe Pg. 154
/Types of Legs /Tipos de Patas

Parure Pg. 156
/Parure /Parure



SPIRIT

Finiture disponibili: Laccato opaco.
Piedi disponibili: Di serie piede Tondino.
Optional piede Ramo.

Available finishes: Matt lacquered.
Available feet: Tondino foot as standard.
Optional Ramo foot.

Acabados disponibles: Lacado mate.
Pies disponibles: De serie pie Tondino.
Opcional pie Ramo.

Misure ingombro finito:
Finished overall dimensions:
Medidas de máximo espacio ocupado:
L 97 P 203,5 H 91,7 cm
L 97 P 213,5 H 91,7 cm
L 127 P 203,5 H 91,7 cm
L 127 P 213,5 H 91,7 cm

Piedi disponibili



Tondino di serie



Ramo optional

Misure rete disponibile:
Available bedspring sizes:
Medidas red disponible:
90x190
90x200
120X190
120X200



ORIGAMI

Finiture disponibili: Laccato opaco.
Piedi disponibili: Di serie piede Ramo.
Optional piede Tondino.

Available finishes: Matt lacquered.
Available feet: Ramo foot as standard.
Optional Tondino foot.

Acabados disponibles: Lacado mate.
Pies disponibles: De serie pie Ramo.
Opcional pie Tondino.

Misure ingombro finito:
Finished overall dimensions:
Medidas de máximo espacio ocupado:
L 97 P 203,5 H 91,7 cm
L 97 P 213,5 H 91,7 cm
L 127 P 203,5 H 91,7 cm
L 127 P 213,5 H 91,7 cm

Piedi disponibili



Ramo di serie



Tondino optional

Misure rete disponibile:
Available bedspring sizes:
Medidas red disponible:
90x190
90x200
120X190
120X200



GINGER

Finiture testiera: Laccato poro aperto, laccato opaco e Frassino cenere.
Finiture rivestimenti: Tessuti a campionario.

Headboard finishes: Open pore lacquered, matt lacquered and Ash-grey ash.
Covering finishes: Our range of fabrics.

Acabado cabecera: Lacado poro abierto, lacado mate y Fresno ceniza.
Acabados revestimientos: Tejidos de muestrario.

Misure ingombro finito:
Finished overall dimensions:
Medidas de máximo espacio ocupado:
L 120 P 225,5 H 92,1 cm
L 120 P 235,5 H 92,1 cm
L 150 P 225,5 H 92,1 cm
L 150 P 235,5 H 92,1 cm

Misure rete disponibile:
Available bedspring sizes:
Medidas red disponible:
90x190
90x200
120x190
120x200



CLIO

Disponibile anche con contenitore.
Finiture disponibili: Laccato poro aperto, laccato opaco, laccato lucido,
Rovere termocotto, Frassino cenere.

Also available with storage unit.
Available finishes: Open pore lacquered, matt lacquered, gloss lacquered
Heat-treated Oak, Ash-grey ash.

Disponibile también con contenedor.
Acabados disponibles: Lacado poro abierto, lacado mate, lacado brillantes
Roble termotratado, Fresno ceniza.

Misure ingombro finito:
Finished overall dimensions:
Medidas de máximo espacio ocupado:
L 106 P 215,4 H 90 cm
L 106 P 225,4 H 90 cm
L 136 P 215,4 H 90 cm
L 136 P 225,4 H 90 cm

Misure rete disponibile:
Available bedspring sizes:
Medidas red disponible:
90x190
90x200
120X190
120X200

LETTI

Beds
Camas



BRAVO

Disponibile anche con contenitore.
Finiture disponibili: Tessuti a campionario.
Piedi disponibili: Di serie piede Tondino.
Optional piede Ramo o Light.

Also available with storage unit.
Available finishes: Fabrics collection.
Available feet: Tondino foot as standard.
Optional Ramo or Light.

Disponible también con contenedor.
Acabados disponibles: Tejidos colección.
Pies disponibles: De serie pie Tondino.
Opcional pie Ramo o Light.

Piedi disponibili



Tondino di serie



Ramo optional



Light optional

Misure ingombro finito:
Finished overall dimensions:
Medidas de máximo espacio ocupado:
L 102 P 210 H 94 cm
L 102 P 220 H 94 cm
L 132 P 210 H 94 cm
L 132 P 220 H 94 cm

Misure rete disponibile:
Available bedspring sizes:
Medidas red disponible:
90x190
90x200
120x190
120x200



AMAMI

Letto con o senza contenitore.
Optional: trapuntini in tessuti a campionario.
Letto retro finito.
Finiture disponibili: Tessuti a campionario.

Bed with or without storage unit.
Optional: quilts in fabrics sample.
Bed with back end
Available finishes: Fabrics collection.

Cama con o sin contenedor.
Opcional: colchas en tejidos del muestrario.
Cabezer totalmente acabado.
Acabados disponibles: Tejidos colección.

Misure ingombro finito:
Finished overall dimensions:
Medidas de máximo espacio ocupado:
L 123 P 220 H 97 cm
L 123 P 230 H 97 cm
L 153 P 220 H 97 cm
L 153 P 230 H 97 cm

Misure rete disponibile:
Available bedspring sizes:
Medidas red disponible:
90x190
90x200
120x190
120x200



SEVEN

Disponibile anche con contenitore.
Finiture disponibili: Tessuti a campionario.
Piedi disponibili: Di serie piede Tondino.
Optional piede Ramo o Light.

Also available with storage unit.
Available finishes: Fabrics collection.
Available feet: Tondino foot as standard.
Optional Ramo or Light.

Disponible también con contenedor.
Acabados disponibles: Tejidos colección.
Pies disponibles: De serie pie Tondino.
Opcional pie Ramo o Light.

Piedi disponibili



Tondino di serie



Ramo optional



Light optional

Misure ingombro finito:
Finished overall dimensions:
Medidas de máximo espacio ocupado:
L 97 P 212 H 95 cm
L 97 P 222 H 95 cm
L 127 P 212 H 95 cm
L 127 P 222 H 95 cm

Misure rete disponibile:
Available bedspring sizes:
Medidas red disponible:
90x190
90x200
120x190
120x200



PIUMA

Disponibile anche con contenitore.
Finiture giroletto: Laccato opaco, Frassini cenere e Rovere termocotto.
Finiture testata: Tessuti a campionario.
Piedi disponibili: Di serie piede Legno.
Optional piede Ramo, Light o Tondino.

Also available with storage unit.
Bed frame finishes: Matt lacquer, Ash-grey ash, Heat-treated Oak.
Headboard finishes: Our range of fabrics.
Available feet: Legno foot as standard.
Optional Ramo, Light or Tondino foot.

Disponible también con contenedor.
Acabados aro de cama: Lacado mate, Fresno ceniza, Roble termotratado.
Acabados cabecero: Tejidos de muestrario.
Pies disponibles: De serie pie Legno.
Opcional pie Ramo, Light o Tondino.

Piedi disponibili



Legno di serie



Tondino optional



Ramo optional



Light optional

Misure ingombro finito:
Finished overall dimensions:
Medidas de máximo espacio ocupado:
L 101 P 216,1 H 89,6 cm
L 101 P 226,1 H 89,6 cm
L 131 P 261,1 H 89,6 cm
L 131 P 226,1 H 89,6 cm

Misure rete disponibile:
Available bedspring sizes:
Medidas red disponible:
90x190
90x200
120x190
120x200

LETTI

Beds
Camas



Particolare: Testiera con cuciture a punto cavallo
Detail: Headboard with blanket stitching
Detalle: Cabecera con costuras a punto caballo

SASSO

Disponibile anche con contenitore.
Finiture disponibili: Tessuti a campionario.

Also available with storage unit.
Available finishes: Fabrics collection.

Disponible también con contenedor.
Acabados disponibles: Tejidos colección.

Misure ingombro finito:
Finished overall dimensions:
Medidas de máximo espacio ocupado:
H 108 L 217 H 86 cm
H 108 L 227 H 86 cm
H 138 L 217 H 86 cm
H 138 L 227 H 86 cm

Misure rete disponibile:
Available bedspring sizes:
Medidas red disponible:
90x190
90x200
120x190
120x200



ROCK

Disponibile anche con contenitore.
Finiture piano estraibile: Laccato opaco.
Finiture disponibili: Tessuti a campionario.
Penisola: Disponibile dx e sx (in foto Sx).

Also available with storage unit.
Pullout top finishes: Matt lacquered.
Available finishes: Fabrics collection.
Peninsula: RH and LH available (LH in photo)

Disponible también con contenedor.
Acabados tablero extraíble: Lacado mate.
Acabados disponibles: Tejidos colección.
Península: Disponible derecha e izquierda (en la foto, la izquierda)

Misure ingombro finito:
Finished overall dimensions:
Medidas de máximo espacio ocupado:
L 145/108 P 217 H 81 cm
L 145/108 P 227 H 81 cm

Misure rete disponibile:
Available bedspring sizes:
Medidas red disponible:
90x190
90x200



CLUB

Disponibile anche con contenitore.
Finiture disponibili: Tessuti a campionario.

Also available with storage unit.
Available finishes: Fabrics collection.

Disponible también con contenedor.
Acabados disponibles: Tejidos colección.

Misure ingombro finito:
Finished overall dimensions:
Medidas de máximo espacio ocupado:
L 104 P 218 H 87 cm
L 104 P 228 H 87 cm
L 134 P 218 H 87 cm
L 134 P 228 H 87 cm

Misure rete disponibile:
Available bedspring sizes:
Medidas red disponible:
90x190
90x200
120x190
120x200



FEEL

Disponibile anche con contenitore.
Finiture disponibili: Tessuti a campionario.

Also available with storage unit.
Available finishes: Fabrics collection.

Disponible también con contenedor.
Acabados disponibles: Tejidos colección.

Misure ingombro finito:
Finished overall dimensions:
Medidas de máximo espacio ocupado:
L 146 P 216 H 121 cm
L 146 P 226 H 121 cm

Misure rete disponibile:
Available bedspring sizes:
Medidas red disponible:
120x190
120x200

LETTI

Beds
Camas



JOKER

Disponibile anche con contenitore.

Finiture disponibili: Colori laccato opaco, Materico Frassino cenere, Materico Rovere termocotto, Materico Poro aperto.

Also available with storage unit.

Available finishes: Matt lacquered colours, Textured Ash-grey ash, Textured Heat-treated Oak, Textured Open pore.

Disponibile también con contenedor.

Acabados disponibles: Colores lacado mate, Texturizado Fresno ceniza, Textured Roble termotratado, Texturizado Open pore.

Misure ingombro finito:

Finished overall dimensions:
Medidas de máximo espacio ocupado:
L 106 P 206,6 H 96,1 cm
L 106 P 216,6 H 96,1 cm
L 136 P 206,6 H 96,1 cm
L 136 P 216,6 H 96,1 cm

Misure rete disponibile:

Available bedspring sizes:
Medidas red disponible:
90x190
90x200
120X190
120X200



NARCISO

Disponibile anche con contenitore.

Finiture disponibili: Colori laccato opaco, Materico Frassino cenere, Materico Rovere termocotto, Materico Poro aperto.

Also available with storage unit.

Available finishes: Matt lacquered colours, Textured Ash-grey ash, Textured Heat-treated Oak, Textured Open pore.

Disponibile también con contenedor.

Acabados disponibles: Colores lacado mate, Texturizado Fresno ceniza, Textured Roble termotratado, Texturizado Open pore.

Misure ingombro finito:

Finished overall dimensions:
Medidas de máximo espacio ocupado:
L 106 P 214,4 H 90 cm
L 106 P 224,4 H 90 cm
L 136 P 214,4 H 90 cm
L 136 P 224,4 H 90 cm

Misure rete disponibile:

Available bedspring sizes:
Medidas red disponible:
90x190
90x200
120X190
120X200



NUVOLA

Disponibile anche con contenitore.

Finiture disponibili: Tessuti a campionario.
Piedi disponibili: Di serie piede Light.
Optional piede Tondino o Ramo.

Also available with storage unit.

Available finishes: Fabrics collection.
Available feet: Light foot as standard.
Optional Tondino or Ramo foot.

Disponibile también con contenedor.

Acabados disponibles: Tejidos colección.
Pies disponibles: De serie pie Light.
Opcional pie Tondino o Ramo.

Piedi disponibili



Light di serie



Tondino optional



Ramo optional

Misure ingombro finito:

Finished overall dimensions:
Medidas de máximo espacio ocupado:
L 102 P 210 H 96 cm
L 102 P 220 H 96 cm
L 132 P 210 H 96 cm
L 132 P 220 H 96 cm

Misure rete disponibile:

Available bedspring sizes:
Medidas red disponible:
90x190
90x200
120x190
120x200

SISTEMA CORNER

Corner system
Sistema corner

Disponibile di serie nella versione con sponda alzabile o con box contenitore laterale.
Finiture disponibili: Tessuti a campionario.

Available standard in the version with liftable side or with side storage box.
Available finishes: Fabrics collection.

Disponibile de serie en la versión con barandilla elevable o con box contenedor lateral.
Acabados disponibles: Tejidos colección.



CORNER SOMMIER

Misure ingombro finito:
Finished overall dimensions:
Medidas de máximo espacio ocupado:
L 102 P 202 H 35 cm

Misure rete disponibile:
Available bedspring sizes:
Medidas red disponible:
90x190



CORNER TESTIERA

Misure ingombro finito:
Finished overall dimensions:
Medidas de máximo espacio ocupado:
L 102 P 202 H 84

Misure rete disponibile:
Available bedspring sizes:
Medidas red disponible:
90x190



ESEMPIO DX

CORNER SPONDA SAGOMATA (A SX O DX)

Misure ingombro finito:
Finished overall dimensions:
Medidas de máximo espacio ocupado:
L 102 P 202 H 84

Misure rete disponibile:
Available bedspring sizes:
Medidas red disponible:
90x190



ESEMPIO DX

CORNER SPONDA ALTA (A SX O DX)

Misure ingombro finito:
Finished overall dimensions:
Medidas de máximo espacio ocupado:
L 102 P 202 H 84

Misure rete disponibile:
Available bedspring sizes:
Medidas red disponible:
90x190

SISTEMA APERTURE

Opening system
Sistema aberturas



DI SERIE

CORNER CON SPONDA ALZABILE



OPTIONAL

CORNER CON CONTENITORE

OPTIONAL 2 RETI

Optional 2 bedsprings
Opcional 2 redes



RETE ESTRAIBILE "BASIC"

Misure materasso:
Mattress sizes:
Medidas colchón:
80x185 H 12



RETE ESTRAIBILE "PLUS" CON RUOTE

Misure materasso:
Mattress sizes:
Medidas colchón:
80x185 H 8

COMPLEMENTI

Complements
Complementos

33

Tavolino da salotto. Coffee-table. Mesita para salón.

Ø 40 H 38 cm.

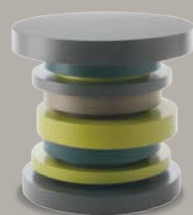

Cod. 33.01

Finiture: Piombo 129, Petrolio 149, Oliva 147 e Grigio Piacenza 130.

Finishes: Lead 129, Petrol blue 149, Olive 147 and Piacenza Grey 130.

Acabados: Plomo 129, Petróleo 149, Oliva 147 y Gris Piacenza 130.



Cod. 33.02

Finiture: Petrolio 149, Oliva 147, Bianco gesso 121 e madreperla 124.

Finishes: Petrol blue 149, Olive 147, Chalk white 121 and Mother of pearl 124.

Acabados: Petróleo 149, Oliva 147, Blanco yeso 121 y Madreperla 124.



Cod. 33.03

Finiture: Petrolio 149, Arancio 148, Bianco gesso 121 e Piombo 129.

Finishes: Petrol blue 149, Orange 148, Chalk white 121 and Lead 129.

Acabados: Petróleo 149, Naranja 148, Blanco yeso 121 y Plomo 129.



Cod. 33.04

Finiture: Ottanio 172, Nero fumo 131 e Bianco gesso 121.

Finishes: Teal 172, Smoke black 131 and Chalk white 121.

Acabados: Verde oscuro 172, Negro humo 131 y Blanco yeso 121.



Cod. 33.05

Finiture: Oceano 143, Celeste 142, Grigio Piacenza 130 e Madreperla 124.

Finishes: Ocean blue 143, Light blue 142, Piacenza Grey 130 and Mother of pearl 124.

Acabados: Océano 143, Celeste 142, Gris Piacenza 130 y Madreperla 124.



COD. 33.06

Finiture: Piombo 129, Arancio 148, Grigio Piacenza 130 e Madreperla 124.

Finishes: Lead 129, Orange 148, Piacenza Grey 130, and Mother of pearl 124.

Acabados: Plomo 129, Naranja 148, Gris Piacenza 130 y Madreperla 124.



COD. 33.07

Finiture: Grigio Piacenza 130, Madreperla 124 e Bianco gesso 121.

Finishes: Piacenza Grey 130, Mother of pearl 124 and Chalk white 121.

Acabados: Gris Piacenza 130, nácar 124 y Blanco yeso 121.



Cod. 33.08

Finiture: Grigio Piacenza 130, Arancio 148, Camomilla 139 e Piombo 129.

Finishes: Piacenza Grey 130, Orange 148, Chamomile 139 and Lead 129.

Acabados: Gris Piacenza 130, Naranja 148, Manzanilla 139 y Plomo 129.

CARUSO

L 44,5 P 44 H 43,1 cm.



Tavolino da salotto.
Finiture disponibili:

Piano in tutti i colori laccati opachi, laccati lucidi e laccati poro aperto. Struttura in metallo in tutti i colori laccati opachi.

Coffee-table.
Available Finishes:

Top in all the matt lacquered, gloss lacquered and open pore lacquered colours. Metal structure in all matt lacquered colours.

Mesita para salón.

Acabados disponibles: Sobre en todos los colores lacados mate, lacados brillantes y lacados poro abierto. Estructura de metal en todos los colores lacado mate.

ECLISSE

L 55 P 45 H 45 cm.



Tavolino da salotto rotondo.

Finiture disponibili:

Piano in tutti i colori laccati opachi, laccati lucidi e laccati poro aperto. Struttura in metallo in tutti i colori laccati opachi.

Round coffee-table.

Available Finishes:

Top in all the matt lacquered, gloss lacquered and open pore lacquered colours. Metal structure in all matt lacquered colours.

Mesita redonda para el salón.

Acabados disponibles: Sobre en todos los colores lacados mate, lacados brillantes y lacados poro abierto. Estructura de metal en todos los colores lacado mate.

JOY

Ø 100 H 26 cm.

Ø 45 H 46 cm.

Ø 60 H 38 cm.



Tavolino da salotto rotondo.

Finiture disponibili:

Struttura cromata o laccato opaco, piano in laccato opaco, poro aperto o Beton e Sherwood.

Round coffee-table.

Available Finishes:

Matt lacquered colours or metal structure, top matt lacquered colours, open pore beton or Sherwood.

Mesita redonda para el salón.

Acabados disponibles: Estructura metal lacado mate color o cromado con tablero lacado mate, lacado poro abierto, Beton o Sherwood.

COMPLEMENTI

Complements
Complementos



JOY DECOR

Tavolino da salotto rotondo serigrafato.
Finiture disponibili: Di serie con piano e basamento in metallo laccato opaco Bianco o Piombo.

Round coffee-table with serigraph.
Available Finishes: Available in the standard version with matt White or Lead lacquered metal base and top.

Mesita redonda con serigrafía para el salón.
Acabados disponibles: Disponible de serie con sobre y base de metal lacado mate Blanco o Plomo.

Ø 45 H 46 cm. Ø 60 H 38 cm. Ø 100 H 25 cm. (esclusa serigrafia)
(excluded serigraph)
(excluir serigrafía)



Basamento disponibile anche laccato opaco in tutti i colori.
Base also available matt lacquered in all the colours of our range.
Base disponible también en lacado mate en todos los colores.

Grafiche per piano PIOMBO disponibili in Ø 45 o Ø 60 cm
Graphics for floor LEAD available in ø 45 or ø 60 cm
Graphics for floor WHITE available in ø 45 or ø 60 cm

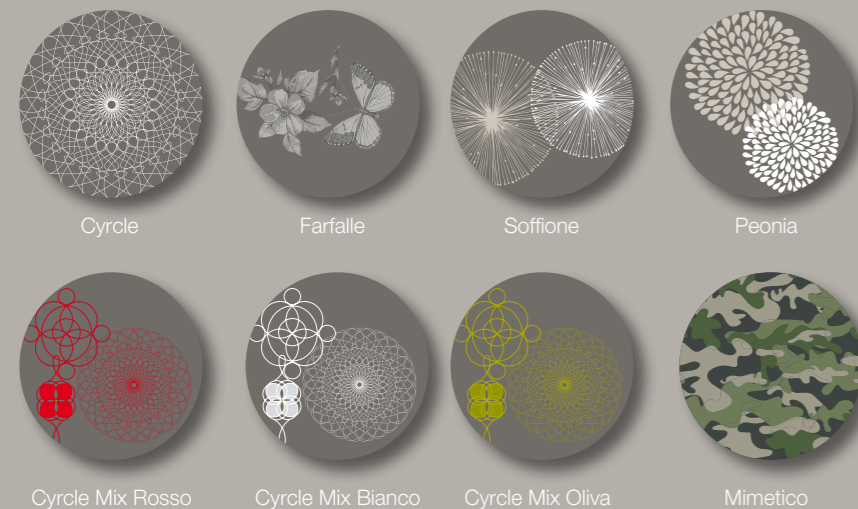

Grafiche per piano BIANCO disponibili in Ø 45 o Ø 60 cm
Gráficas para tablero PLOMO disponibles en ø 45 o ø 60 cm
Gráficas para tablero BLANCO disponibles en ø 45 o ø 60 cm

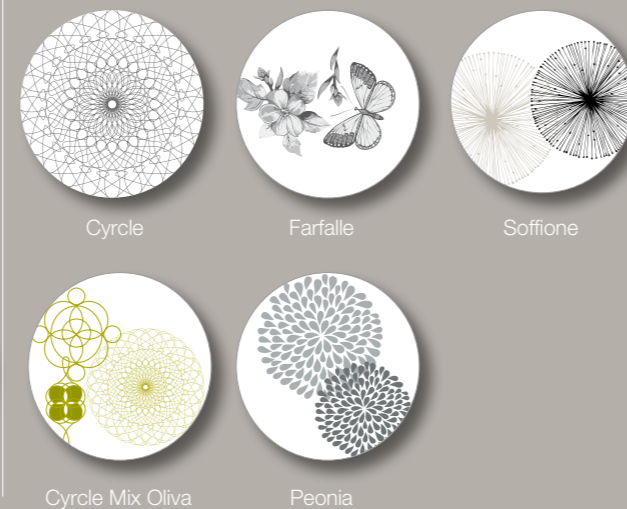

COOKIE

Pouff rivestito in tessuto con tasca e cuciture a contrasto.
Finiture disponibili: Disponibile in versione monocolor in tutti i tessuti a campionario. In versione bicolore abbinamenti vincolati dalla singola tirella.

Pouf covered in fabric with pocket and contrasting stitching.
Available finishes: Available in the single-coloured version in all the fabrics of our range. The two-toned version is available in the combinations shown in each fabric swatch only.

Puf revestido en tejido con bolsillo y costuras a contraste.
Acabados disponibles: Disponible en versión monocolor en todos los tejidos del muestrario. En versión bicolore combinaciones vinculadas a la tira correspondiente.

L 47 P 47 H 46 cm.



COMPLEMENTI

Complements
Complementos



CIKO

Contenitore sospeso.
Finiture disponibili struttura:

Finiture disponibili schiena:

Suspended container.
Structure available finishes:

Back available finishes:

Contenedor colgante.
Acabados disponibles estructura:

Acabados disponibles respaldo:

L 36 P 24 H 36 cm.

Metallo laccato opaco Piombo o colori a campionario.
Laccato opaco Piombo, colori a campionario, colori fluo e grafiche.

Matt lacquered metal Lead or colours as per sample collection.
Matt lacquered Lead, colours as per sample collection, fluorescent colours and graphics.

Metal lacado mate Plomo o colores del muestrario.
Lacado mate Plomo, colores del muestrario, colores fluo y gráficas.



Struttura Piombo
Schiena Piombo

Lead Structure
Lead Back

Estructura Plomo
Respaldo Plomo



Struttura Piombo
Schiena Rosso Fluo

Lead Structure
Red Fluo Back

Estructura Plomo
Respaldo Rojo Fluo



Struttura Bianca
Schiena Camomilla

White Structure
Chamomile Back

Estructura Blanco
Respaldo Manzanilla



Struttura Bianca
Schiena Grafica Farfalle

White Structure
Farfalle Graphics Back

Estructura Blanco
Respaldo Gráficas Farfalle

GRAFICHE CIKO

Graphics
Gráficas Ciko



Papavero rosso



Papavero Verde



Jeans Blu

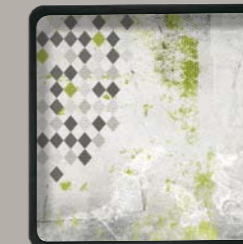

Tartan Verde

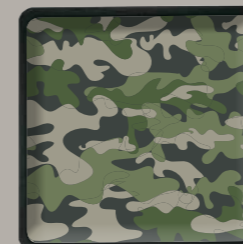

Mimetico



Farfalle



Banano

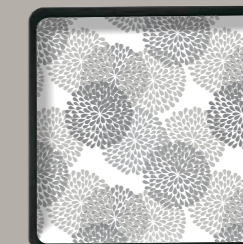

Peonie

COLORI FLUO SCHIENE CIKO

Back Colours Fluo Ciko
Respaldo Colores Fluo Ciko



Rosso Fluo



Rosa Fluo



Giallo Fluo



Verde Fluo

COMPLEMENTI

Complements
Complementos



MOVIDA

L 37,8/73,8 P 37,8 H 190 cm.

Libreria con struttura di serie in metallo laccato opaco Piombo 129, optional laccato opaco nei colori a campionario. Ripiani in laccato opaco, poro aperto, Rovere termocotto o Frassino cenere. Contenitore Pedro in Beton e Sherwood.

Bookcase with standard structure in matt 129 Lead lacquered metal, also available matt lacquered in our range of colours. Shelves in open pore matt lacquers, Heat-treated Oak or Ash-grey ash. Beton or Sherwood finish Pedro unit.

Librería con estructura de serie de metal lacado mate Plomo 129, opcional lacado mate en los colores del muestrario. Baldas en lacado mate poro abierto, Roble termotratado o Fresno ceniza. Contenedor Pedro en Beton o Sherwood.



RASTER VERTICALE

L 18 P 30,5 H 144 cm.

Di serie struttura in metallo laccato opaco Piombo 129, optional laccato opaco nei colori a campionario. Interni laccato opaco nei colori a campionario, materico Rovere termocotto, Materico Frassino cenere e Materico Poro aperto.

Standard supplied with structure in matt 129 Lead lacquered metal, also available matt lacquered in our range of colours. Inside in matt lacquered in our range of colours, Textured Heat-treated Oak, Textured Ash-grey ash and Textured Open pore.

De serie estructura de metal lacado mate Plomo 129, opcional lacado mate en los colores del muestrario. Interiores lacado mate en los colores del muestrario, Texturizado Roble termotratado, Texturizado Fresno ceniza y Texturizado Poro abierto.



RASTER ORIZZONTALE

L 144 P 30,5 H 18 cm.

Di serie struttura in metallo laccato opaco Piombo 129, optional laccato opaco nei colori a campionario. Interni laccato opaco nei colori a campionario, materico Rovere termocotto, Materico Frassino cenere e Materico Poro aperto.

Standard supplied with structure in matt 129 Lead lacquered metal, also available matt lacquered in our range of colours. Inside in matt lacquered in our range of colours, Textured Heat-treated Oak, Textured Ash-grey ash and Textured Open pore.

De serie estructura de metal lacado mate Plomo 129, opcional lacado mate en los colores del muestrario. Interiores lacado mate en los colores del muestrario, Texturizado Roble termotratado, Texturizado Fresno ceniza y Texturizado Poro abierto.



CIAO

L 36 P 24 H 110 cm.

Contenitore con struttura in Beton o in Sherwood. Schiena in metallo traforato laccato opaco Bianco gesso 121 o Piombo 129.

Unit with a Beton or Sherwood finish structure. Back perforated panel in matt 121 Chalk white or 129 Lead lacquered metal.

Contenedor con estructura en Beton o en Sherwood. Trasera de metal perforada lacado mate Blanco yeso 121 o Plomo 129.



TASCA FIANCO

L 52 H 230 cm.

Tasca con tubo di fissaggio e pannello magnetico con calamite. Tessuto a campionario. Abbinamenti a scelta vincolati dalla singola tirella.

Holdall with pockets, hanging rail and magnetic board with magnets. Available in our range of fabrics. Available in combinations shown in each fabric swatch only.

Bolsillo con tubo de fijación y tablero magnético con imanes. Tejido de muestrario. Combinaciones a elegir vinculadas a la tira correspondiente.



TASCA PARETE

L 80 H 80 cm.

Tasca con tubo di fissaggio e pannello magnetico con calamite. Tessuto a campionario. Abbinamenti a scelta vincolati dalla singola tirella.

Holdall with pockets, hanging rail and magnetic board with magnets. Available in our range of fabrics. Available in combinations shown in each fabric swatch only.

Bolsillo con tubo de fijación y tablero magnético con imanes. Tejido de muestrario. Combinaciones a elegir vinculadas a la tira correspondiente.

COMPLEMENTI

Complements
Complementos



KALISTA FIANCO

L 45 P 24 H 210 cm.

Struttura metallo laccato opaco
Bianco gesso o laccato opaco nei
colori a campionario.

Structure in matt Chalk white or
matt lacquered metal in our range
of colours.

Estructura metal lacado mate
Blanco yeso o lacado mate en los
colores del muestrario.

KALISTA MIDI

L 60 P 40 H 160 cm.

Struttura metallo laccato opaco
Bianco gesso o laccato opaco nei
colori a campionario.

Structure in matt Chalk white or
matt lacquered metal in our range
of colours.

Estructura metal lacado mate
Blanco yeso o lacado mate en los
colores del muestrario.

KALISTA PANCA

L 80 P 36 H 80 cm.

Struttura metallo laccato opaco
Bianco gesso o laccato opaco nei
colori a campionario. Disponibile con
cuscino in tutti i tessuti a campionario.

Structure in matt Chalk white or
matt lacquered metal in our range
of colours. Available with a cushion in
our range of fabrics.

Estructura metal lacado mate Blanco
yeso o lacado mate en los colores del
muestrario. Disponible con cojín en
todos los tejidos del muestrario.

KALISTA

L 27 P 36 H 80 cm.

Struttura in metallo laccato opaco
Bianco gesso o laccato opaco nei
colori a campionario.

Structure in matt Chalk white or
matt lacquered metal in our range
of colours.

Estructura metal lacado mate
Blanco yeso o lacado mate en los
colores del muestrario.



INSIDE PANNELLO

L 110,2 P 18 H 180 cm.

Composizione C313. Inside pannello a muro disponibile in
laccato opaco, laccato poro aperto con luce led optional.
Vani a giorno in metallo laccato.

Composition C313. Inside wall panel available matt
lacquered, open pore lacquered with optional LED light.
Open compartments in lacquered metal.

Composición C313. Inside panel a pared disponible en
lacado mate, lacado poro abierto con luz led opcional.
Huecos a vista de metal lacado.

INSIDE SPECCHIERA

L 91,1 P 18 H 180 cm.

Composizione Inside pannello a muro
in specchio. Vani a giorno in metallo
laccato.

Composition Inside mirror wall panel.
Lacquered metal open compartments.

Composición Inside panel a pared de
espejo. Huecos a vista de metal lacado.

INSIDE VANO A GIORNO

L 55 P 18 H 18 cm.

Inside vano a giorno in metallo
laccato.

Inside pen compartments in
lacquered metal.

Inside huecos a vista de metal
lacado.

SEDIE E SCRITTOI

Chairs and desks
Sillas y escritorios



SEDIA TIFFANY YOUNG

Finiture disponibili: Tutti i tessuti a campionario con cucitura a scelta.
Available finishes: All our range of fabrics with stitching on request.
Acabados disponibles: Todos los tejidos del muestrario con costura a elegir.



SEDIA BEVERLY RUOTE

Finiture disponibili: Laccato opaco.
Available finishes: Matt lacquered.
Acabados disponibles: Lacado opaco.

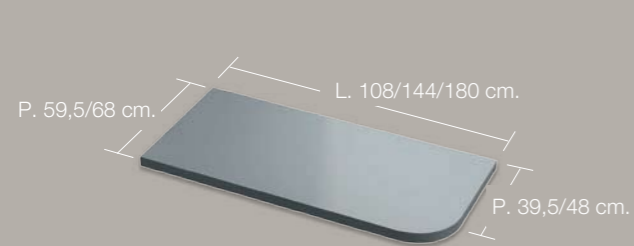

SCRITTOIO 07

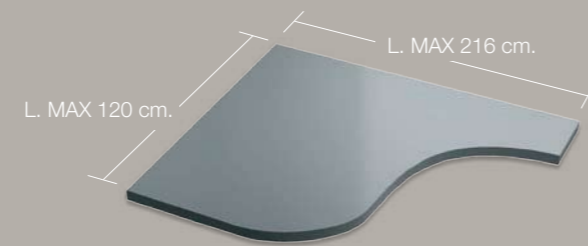

SCRITTOIO 08

A progetto. / To design. / Según proyecto.

Finiture disponibili: Poro aperto, laccato opaco e Frassino cenere.
Available finishes: Open pore lacquered, matt lacquered and Ash-grey ash.
Acabados disponibles: Lacados poro abierto, lacado opaco y Fresno ceniza.

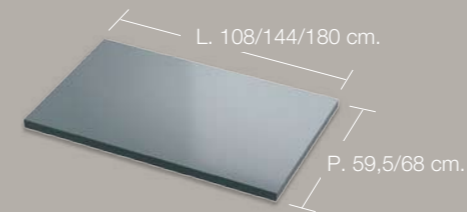

SCRITTOIO 01

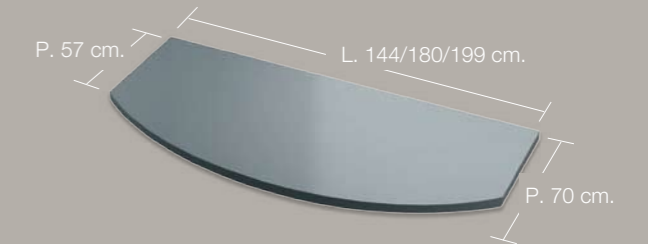

SCRITTOIO 02



SCRITTOIO 03

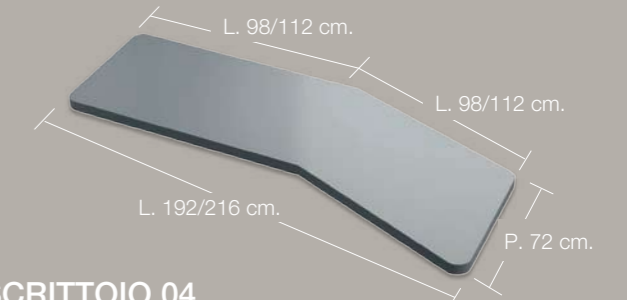

SCRITTOIO 04

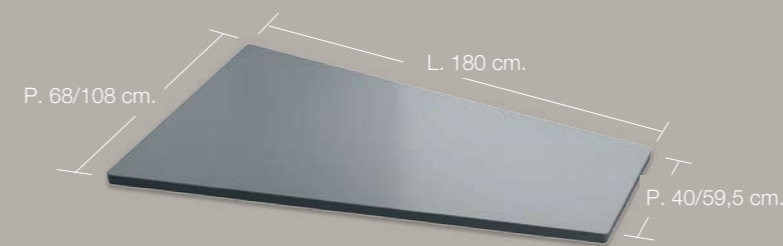

SCRITTOIO 05

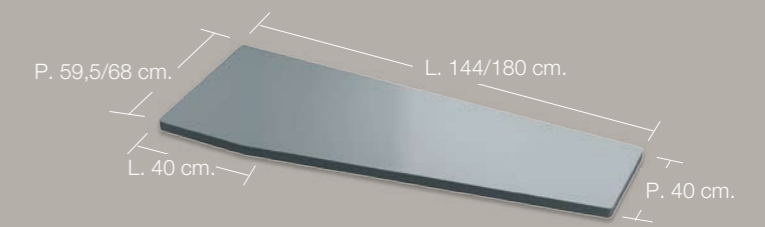

SCRITTOIO 06

Finiture disponibili: Poro aperto, laccato opaco e Frassino cenere.
Available finishes: Open pore lacquered, matt lacquered and Ash-grey ash.
Acabados disponibles: Lacados poro abierto, lacado opaco y Fresno ceniza.

TIPOLOGIE GAMBE

Leg types
Tipologías patas



FIANCO



SLITTA

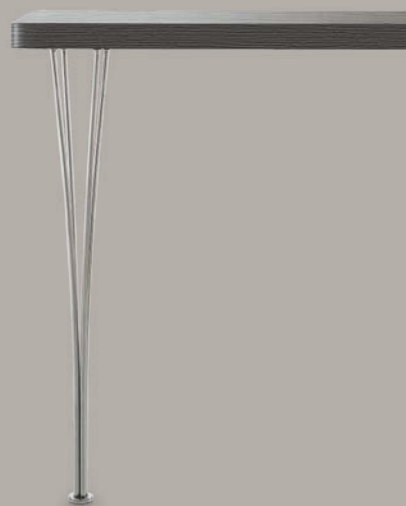

SPILLO

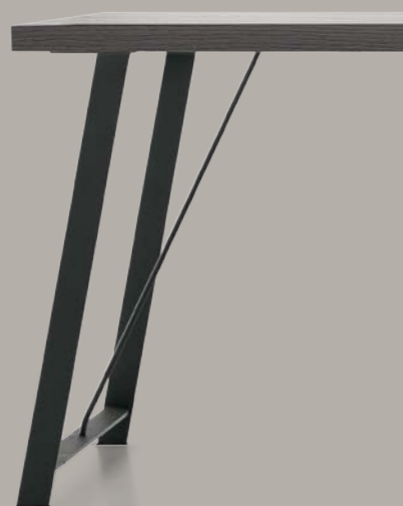

DIAGONAL



METACRILATO

METACRILATO "SCHEMA QUOTE PER RACCORDO"

Methacrylate "dimensions for connection"

Metacrilato "esquema cuotas para racor"



ATLANTE P. 40 /56



REPLAY P. 44

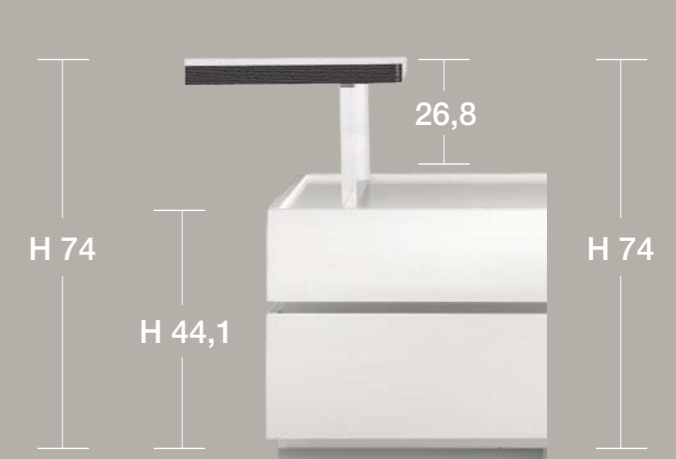

REPLAY P. 44

PARURE

Parure
Parure



PARURE RASO

Parure in raso composta da: sacco copripiumino, federa e lenzuolo sotto.
Disponibile per materasso da 90 e 120 cm.

Satin bed linen composed of: eiderdown cover, pillow case and mattress sheet.
Available for 90 and 120-cm mattresses.

Juego de cama de raso compuesto por: funda de edredón, funda de almohada y sábana bajera.
Disponibile para colchón de 90 y 120 cm.

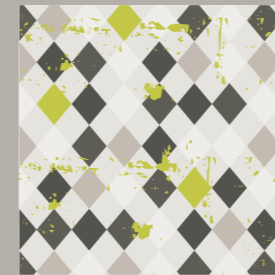

Tartan verde



Farfalle

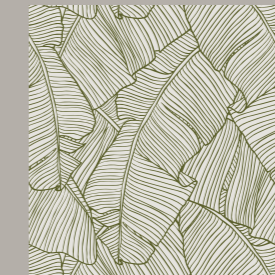

Banano



Peonie



Optical colors

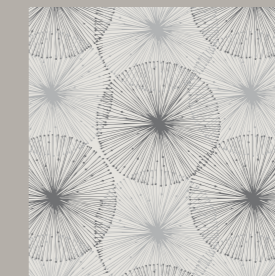

Soffioni



Papavero rosso



Papavero verde



Papavero rosa

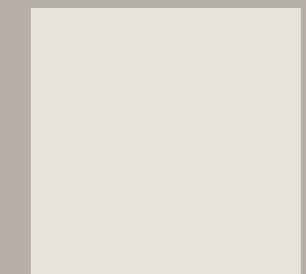

OSTRICA TINTA UNITA

ESSENZE

Woods / Maderas

FC FRASSINO CENERE Ash-grey ash / Fresno ceniza	RT ROVERE TERMOCOTTO Heat-treated Oak / Roble termotratado
--	---

MATERICO

Textured / Texturizado

MATERICO LACCATO PORO APERTO	PA BG BIANCO GESSO Chalk white / Blanco yeso	PA MP MADREPERLA Mother of pearl / Madreperla	MATERICO ESSENZA	MT FC FRASSINO CENERE Ash-grey ash / Fresno ceniza
MATERICO LACCATO OPACO	MT BG BIANCO GESSO Chalk white / Blanco yeso	MT MP MADREPERLA Mother of pearl / Madreperla		

LACCATI PORO APERTO

Open pore lacquered / Lacados poro abierto

221 BIANCO GESSO Chalk white / Blanco yeso	222 PANNA Cream / Nata	224 MADREPERLA Mother of pearl / Madreperla	227 HOT Hot grey / Gris asfalto oscuro
229 PIOMBO Lead / Plomo	230 GRIGIO PIACENZA Piacenza Grey / Gris Piacenza	250 CANAPA Hemp / Cáñamo	252 POMICE Pumice / Pómez
251 ARGILLA Clay / Arcilla			

LACCATI OPACHI E LUCIDI

Matt and gloss lacquered / Lacados mate y brillantes

BEST SELLER	121 BEST SELLER BIANCO GESSO Chalk white / Blanco yeso	124 BEST SELLER MADREPERLA Mother of pearl / Madreperla	122 PANNA Cream / Nata	123 AVORIO Ivory / Marfil
	127 HOT Hot grey / Gris asfalto oscuro	128 SMOKE Smoke / Smoke	129 PIOMBO Lead / Plomo	130 GRIGIO PIACENZA Piacenza Grey / Gris Piacenza
	131 NERO FUMO Smoke black / Negro humo	133 CORALLO Coral / Coral	134 ROSSO Red / Rojo	139 CAMOMILLA Chamomile / Manzanilla
	142 CELESTE Light blue / Celeste	143 OCEANO Ocean blue / Océano	145 PINK Pink / Color de rosa	146 GLICINE Wisteria / Glicina
	147 OLIVA Olive / Oliva	148 ARANCIO Orange / Naranja	149 PETROLIO Petrol blue / Petróleo	150 CANAPA Hemp / Cáñamo
	152 POMICE Pumice / Pómez	151 ARGILLA Clay / Arcilla	172 OTTANIO Teal / Verde oscuro	

VETRI COLORATI LUCIDI E SATINATI

Polished and satin coloured glasses / Vidrios colorados brillante y satinado

321 LUCIDO Polished / Brillante	421 SATINATO Satin / Satinado	322 LUCIDO Polished / Brillante	422 SATINATO Satin / Satinado	323 LUCIDO Polished / Brillante	423 SATINATO Satin / Satinado	324 LUCIDO Polished / Brillante	424 SATINATO Satin / Satinado
BIANCO GESSO / Chalk white / Blanco yeso		PANNA / Cream / Nata		AVORIO / Ivory / Marfil		MADREPERLA / Mother of pearl / Madreperla	
327 LUCIDO Polished / Brillante	427 SATINATO Satin / Satinado	328 LUCIDO Polished / Brillante	428 SATINATO Satin / Satinado	329 LUCIDO Polished / Brillante	429 SATINATO Satin / Satinado	330 LUCIDO Polished / Brillante	430 SATINATO Satin / Satinado
HOT / Hot grey / Gris asfalto oscuro		SMOKE / Smoke / Smoke		PIOMBO / Lead / Plomo		GRIGIO PIACENZA / Piacenza Grey / Gris Piacenza	
331 LUCIDO Polished / Brillante	431 SATINATO Satin / Satinado	333 LUCIDO Polished / Brillante	433 SATINATO Satin / Satinado	334 LUCIDO Polished / Brillante	434 SATINATO Satin / Satinado	339 LUCIDO Polished / Brillante	439 SATINATO Satin / Satinado
NERO FUMO / Smoke black / Negro humo		CORALLO / Coral / Coral		ROSSO / Red / Rojo		CAMOMILLA / Chamomile / Manzanilla	
342 LUCIDO Polished / Brillante	442 SATINATO Satin / Satinado	343 LUCIDO Polished / Brillante	443 SATINATO Satin / Satinado	345 LUCIDO Polished / Brillante	445 SATINATO Satin / Satinado	346 LUCIDO Polished / Brillante	446 SATINATO Satin / Satinado
CELESTE / Light blue / Celeste		OCEANO / Ocean blue / Océano		PINK / Pink / Color de rosa		GLICINE / Wisteria / Glicina	
347 LUCIDO Polished / Brillante	447 SATINATO Satin / Satinado	348 LUCIDO Polished / Brillante	448 SATINATO Satin / Satinado	349 LUCIDO Polished / Brillante	449 SATINATO Satin / Satinado	350 LUCIDO Polished / Brillante	450 SATINATO Satin / Satinado
OLIVA / Olive / Oliva		ARANCIO / Orange / Naranja		PETROLIO / Petrol blue / Petróleo		CANAPA / Hemp / Cáñamo	
352 LUCIDO Polished / Brillante	452 SATINATO Satin / Satinado	351 LUCIDO Polished / Brillante	451 SATINATO Satin / Satinado	372 LUCIDO Polished / Brillante	472 SATINATO Satin / Satinado		
POMICE / Pumice / Pómez		ARGILLA / Clay / Arcilla		OTTANIO / Teal / Verde oscuro			

(SOLO PER ARMADI LOGICA) MILLERIGHE

Millerighe (for Logica wardrobe only) / Millerighe (solo para Logica Armario)



PER LA COLLEZIONE MILLERIGHE SONO DISPONIBILI TUTTI I COLORI LACCATI.

All our lacquer colours are available for the millerighe collection. / Para la colección millerighe están disponibles todos los colores lacados.

(SOLO PER ATLANTE) VETRO

Glasses (for Atlante only) / Vidrios (solo para Atlante)

SATINATO Satin finish/ Satinado

(SOLO PER ARMADI LOGICA) SPECCHI

Mirror (for Logica wardrobe only) / Espejo (solo para Logica Armario)

381 ARGENTATO Silver / Plata	382 BRONZATO Bronze / Bronce
---------------------------------	---------------------------------

(A CAMPIONARIO) TESSUTI

Fabrics (a sample) / Tejidos (una muestra)

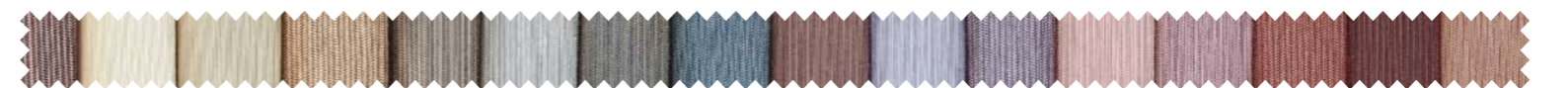

PER LA COLLEZIONE TESSUTI SI PREGA DI FARE RIFERIMENTO AL CAMPIONARIO. / For the fabric collection please refer to the samples. / Para la colección de tejidos cabe referirse al muestrario.

LE FINITURE E I COLORI SONO INDICATIVI E POSSONO SUBIRE VARIAZIONI DOVUTE ALLA TECNICA DI STAMPA. /

Finishings and colours are approximate and they may vary during the printing process. / Los acabados y colores son indicativos y pueden sufrir variaciones en la imprenta.

GRUPPO TOMASELLA si riserva la facoltà di modificare in qualunque momento e senza preavviso, le caratteristiche tecniche degli elementi usati nel presente catalogo. Alcuni accessori presenti nelle immagini fotografiche non sono prodotti dalla ditta GRUPPO TOMASELLA. Si prega di far riferimento al listino prezzi. La ditta GRUPPO TOMASELLA si riserva inoltre il diritto di apportare ai propri prodotti quelle modifiche che si riterranno necessarie o utili al fine di migliorarli senza pregiudicarne le caratteristiche essenziali. È vietata ogni riproduzione totale e parziale in Italia e all'estero.

GRUPPO TOMASELLA reserves the right to modify the technical characteristics of the elements used in the present catalogue at any time and without warning. Some accessories present in the photographs are not produced by GRUPPO TOMASELLA. Please refer to price list. GRUPPO TOMASELLA also reserves the right to carry out modifications which it considers necessary or useful in order to improve its products, without prejudicing the essential characteristics. Total or partial reproduction prohibited in Italy or any other country.

GRUPPO TOMASELLA se reserva la facultad de modificar en cualquier momento y sin previo aviso, las características técnicas de los elementos utilizados en el presente catálogo. Algunos accesorios presentes en las imágenes fotográficas no son fabricados por la empresa GRUPPO TOMASELLA. Rogamos hacer referencia al listín de precios. La empresa GRUPPO TOMASELLA además, se reserva el derecho de aportar a sus productos aquellas modificaciones que considere necesarias o útiles con la finalidad de mejorarlos sin perjudicar sus características esenciales. Se prohíbe toda reproducción total y parcial en Italia y en el extranjero.



Tomasella Industria Mobili s.a.s.

Via Ungaresca, 16 - 33070 Brugnera (PN) Italy

Tel. +39 (0434) 623015 / 607111 - Fax +39 (0434) 624778

www.tomasella.it info@tomasella.it

A.D. Adriani & Rossi Edizioni
Photo: Studio Indoor - Oderzo
Fotolito: Z13 - Verona
Stampa: OGM - PD

Stampato in Italia Ottobre 2013



www.tomasella.it