

ALEVÈ



STOSA
CUCINE

STOSA

UNA FAMIGLIA ITALIANA.
50 ANNI DI STORIA E
UNA SOLA GRANDE
PASSIONE: LA CUCINA.

DA 50 ANNI PRODUCIAMO SOLO CUCINE, CREATE E PRODOTTE PER MIGLIORARE LA VITA DI CHI, OGNI GIORNO, VIVE NELLO SPAZIO PIÙ CONVIVIALE DELLA CASA. PROGETTIAMO E REALIZZAMO ESCLUSIVAMENTE IN ITALIA PRODOTTI ECCELLENTI NELLA QUALITÀ, REALMENTE SOSTENIBILI PER OGNI FAMIGLIA ITALIANA E PER I GIOVANI. ECCO PERCHÉ UNA CUCINA STOSA NASCE DA VALORI AUTENTICI COME IMPEGNO, ONESTÀ, RISPETTO E ORIGINALITÀ. IN ITALIA E IN OLTRE 40 PAESI NEL MONDO, CON UN MERCATO IN COSTANTE ESPANSIONE. IMPEGNO PER DARE IL MEGLIO DI NOI ATTRAVERSO OGNI SINGOLA CUCINA, DIRETTAMENTE A CASA TUA. ONESTÀ PER TRASFORMARE I NOSTRI PROGETTI IN SPAZI DI VITA DAVVERO SOSTENIBILI. RISPETTO PER LA NATURA CHE CI CIRCONDA E PER TUTTA LA FILIERA PRODUTTIVA. ORIGINALITÀ PER ESSERE SEMPRE PIÙ COMPETITIVI NELL'INNOVAZIONE TECNOLOGICA E FUNZIONALE. È COSÌ CHE OGNI GIORNO COSTRUIAMO LE NOSTRE CUCINE. PENSANDO A TE.

STOSA, AN ITALIAN FAMILY. 50 YEARS OF HISTORY AND ONE GREAT PASSION: KITCHENS.

FOR 50 YEARS WE'VE BEEN PRODUCING ONLY KITCHENS, DESIGNED AND BUILT FOR THOSE WHO ENJOY SPENDING TIME IN THE MOST WELCOMING ROOM IN THE HOME. OUR PRODUCTS, DESIGNED AND MADE ENTIRELY IN ITALY, STAND OUT FOR THEIR QUALITY YET ARE AFFORDABLE FOR ITALIAN FAMILIES AND YOUNG PEOPLE. BECAUSE A STOSA KITCHEN IS BASED ON AUTHENTIC VALUES LIKE COMMITMENT, HONESTY, RESPECT AND ORIGINALITY - IN ITALY AND A FURTHER 40 COUNTRIES WORLDWIDE, WITH A CONSTANTLY GROWING MARKET. COMMITMENT TO OFFER OUR BEST IN EVERY SINGLE KITCHEN, DIRECTLY IN YOUR OWN HOME. HONESTY TO TURN OUR DESIGNS INTO TRULY SUSTAINABLE LIVING AREAS. RESPECT FOR THE NATURE SURROUNDING US AND FOR THE WHOLE PRODUCTION CHAIN. ORIGINALITY TO BE MORE AND MORE COMPETITIVE WITH REGARDS TECHNOLOGICAL AND PRACTICAL INNOVATION. THAT'S HOW WE BUILD OUR KITCHENS EVERY DAY. THINKING OF YOU.

ALEVÈ



ALEVÈ

LA CUCINA
CHE TI OFFRE
MOLTISSIME
POSSIBILITÀ
DI SCELTA.

ANTA CON O SENZA MANIGLIA,
SORPRENDENTI FINITURE
DA ABBINARE PER OTTENERE
LA MASSIMA PERSONALIZZAZIONE.

ALEVÈ
THE KITCHEN
THAT OFFERS
A PLETHORA
OF CHOICES.

DOOR WITH OR WITHOUT A HANDLE,
SURPRISING FINISHES TO MATCH
FOR THE MAXIMUM CUSTOMISATION.

SCELGO L'ANTA CON IL SISTEMA GOLA

I select the door with the Groove System.

PRESA MANIGLIA / HANDLE SOCKET P. 10



TASCA / POCKET P. 32



SCELGO L'ANTA CON LA MANIGLIA

I select the door with the handle.

MANIGLIE / HANDLES P. 36

STOSA CUCINE ti offre una vasta serie di maniglie da abbinare all'anta del modello ALEVÈ: cromate, satinare, dalla forma lineare o arcuata, scegli tu quella più adatta allo stile che vuoi dare alla tua cucina!



STOSA KITCHENS offer you a wide range of handles to combine with the ALEVÈ model door: chrome-plated, satin, linear or arched, select the one that best suits the style you want for your kitchen!



ALEVÈ DECOR

Laminati bordo in tinta
Laminated edge to match

- Tela
- Argilla
- Olmo Crystal
- Olmo Mercurio



ALEVÈ LUX

Laccati UV bordo bicolor
Lacquers UV two-tone edge

- Ardesia
- Neve
- Arena
- Malta
- Cielo
- Ecru

1 LACCATI DIRETTI

OPACHI E LUCIDI
MATT AND LACQUERED
Di serie / Standard

..... Ice

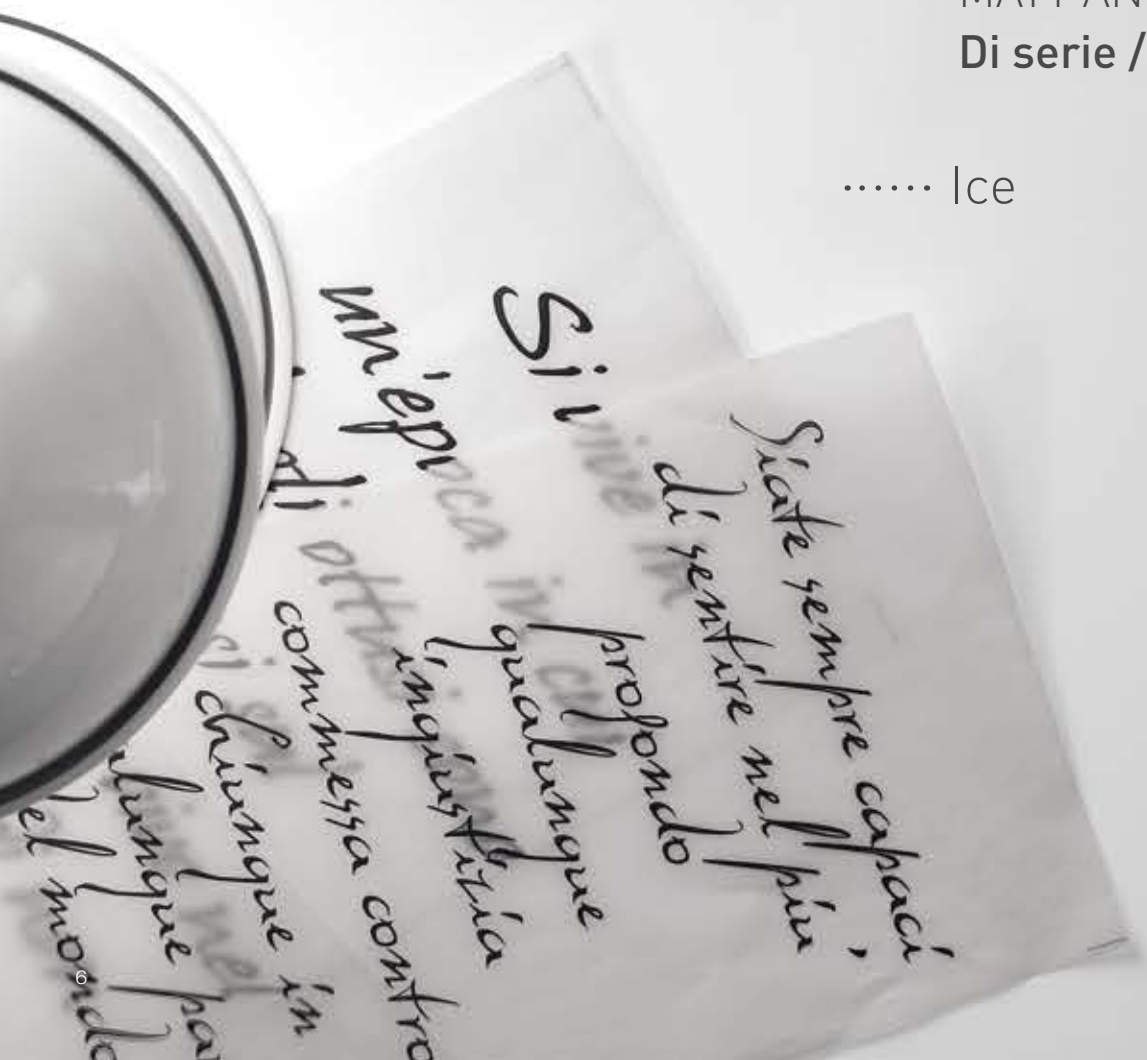

7 LACCATI DIRETTI

OPACHI E LUCIDI
MATT AND LACQUERED
A richiesta / On demand

Creta

Monolite

Nuvola

Fango

Frost

Oliva

Pomice



Le possibilità del SISTEMA **GOLA**

Groove SYSTEM possibility



PRESA MANIGLIA SOCKET HANDLE

Linee forti, decise percorrono le composizioni che utilizzano la presa maniglia. Un elemento decorativo e funzionale che punta all'essenzialità.
Per gli amanti del design.

Strong, decisive lines are found throughout arrangements that use the handle grip. A decorative and functional element that focuses on the essential.
For lovers of design.

Finiture GOLA / GOLA Finishes

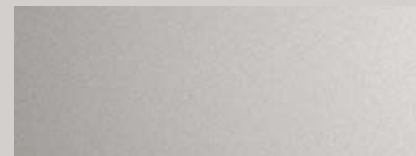

Brill
Brill

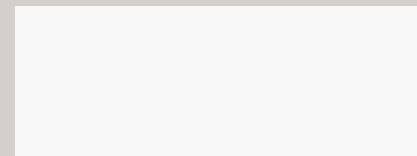

Bianco
White

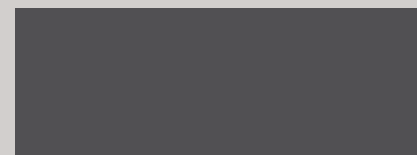

Piombo
Lead

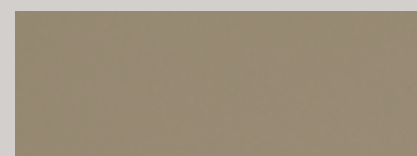

Corda
Cord

TASCA POCKET

L'anta nasconde un segreto, la maniglia integrata. La presa è decisa, sicura, invisibile: forma e funzione perfettamente in equilibrio.
Forme pure e minimali.

The door hides a secret, the built in handle. The grip is decisive, secure, invisible: shape and function in perfect balance.
Pure and minimal shapes.



Finiture TASCA / TASCA Finishes

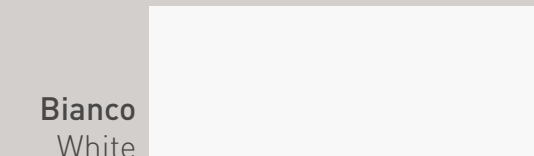

Bianco
White

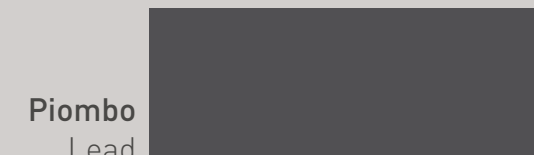

Piombo
Lead



Brill
Brill

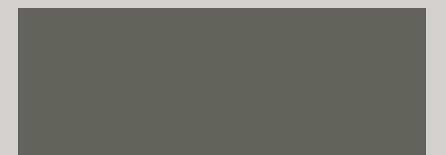

Peltro
Pewter



Composizione 01_ L1 304 L2 270 cm. Colonne L 282 cm.

Isola centrale con basi in laccato Diretto lucido Oliva. Colonne in laccato diretto lucido Fango. Elementi a giorno in legno invecchiato finitura rovere Olivato. Piano tavolo e gambone telescopico in finitura rovere Alaska. / Central island with glossy Olive directly varnished bases. Glossy Mud directly varnished tall units. Open elements in aged wood with Olivato oak finish. Table surface and telescopic leg in Alaska oak finish.



Composizione 01 **LOOK SYSTEM** h 72 cm

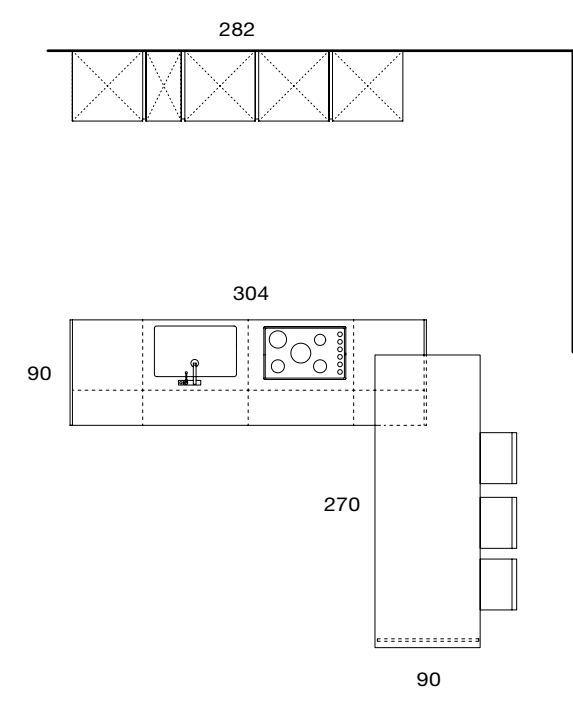

Composizione 01_ L1 304 L2 270 cm. Colonne L 282 cm.
 Isola centrale con basi in laccato Diretto lucido Oliva. Colonne in laccato diretto lucido Fango. Elementi a giorno in legno invecchiato finitura rovere Olivato. Piano tavolo e gambone telescopico in finitura rovere Alaska.
 / Central island with glossy Olive directly varnished bases. Glossy Mud directly varnished tall units. Open elements in aged wood with Olivato oak finish. Table surface and telescopic leg in Alaska oak finish.

Diretto laccato lucido
glossy lacquered

Fango	Mud	Oliva	Olive	



DECISA PERSONALITÀ

STRONG PERSONALITY

AL CENTRO UN'ISOLA CHE NON HA EGUALI PER CREARE POSTO CHE NON ESISTEVA PRIMA E OFFRIRE UNO SPAZIO OSPITALE!

In the centre is an island that knows no equals, to make space you didn't have before and offer a welcoming area!



Composizione 01_ L1 304 L2 270 cm. Colonne L 282 cm.

Isola centrale con basi in laccato Diretto lucido Oliva. Colonne in laccato diretto lucido Fango. Elementi a giorno in legno invecchiato finitura rovere Olivato. Piano tavolo e gambone telescopico in finitura rovere Alaska. / Central island with glossy Olive directly varnished bases. Glossy Mud directly varnished tall units. Open elements in aged wood with Olivato oak finish. Table surface and telescopic leg in Alaska oak finish.



Composizione 02_ Isola L 274 cm. L1 456/480 L 240 cm.

Isola centrale con basi in finitura laccato lucido UV Malta. Colonne in laccato lucido UV Ardesia. Basi in finitura laccato lucido UV Malta. Elementi a giorno in laccato opaco giallo e in finitura Alevè Decor Olmo Mercurio. / Central island with glossy, varnished UV Mortar finished bases. Glossy, varnished UV Slate Grey tall units. Glossy, varnished UV Mortar finished bases. Open, yellow matt varnished elements with Alevè Decor Mercury Olmo finish.

SPAZIO CONTEMPORANEO

CONTEMPORARY SPACE



Composizione 02_ Isola L 274 cm. L1 456/480 L 240 cm.
 Isola centrale con basi in finitura laccato lucido UV Malta. Colonne in laccato lucido UV Ardesia.
 Basi in finitura laccato lucido UV Malta. Elementi a giorno in laccato opaco giallo e in finitura Aleve
 Decor Olmo Mercurio. / Central island with glossy, varnished UV Mortar finished bases. Glossy,
 varnished UV Slate Grey tall units. Glossy, varnished UV Mortar finished bases. Open, yellow
 matt varnished elements with Aleve Decor Mercury Olmo finish.

Composizione 02

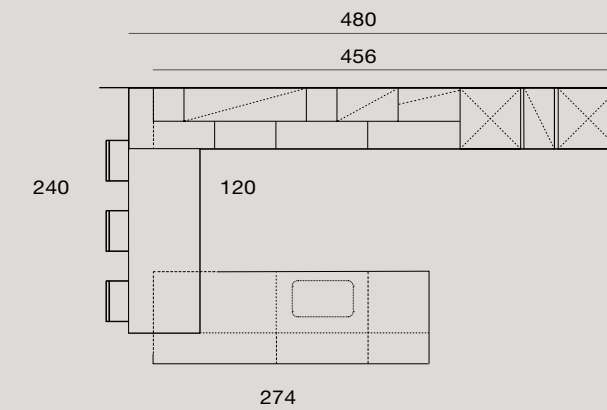

Alevè Lux	laccato lucido UV glossy lacquered UV	Alevè Decor	laminato laminated
Malta	bordo bicolor bicolor edge	Ardesia	bordo bicolor bicolor edge
			Olmo Mercurio bordo in tinta Mercury Elm edge matching

Laccato opaco
matt lacquered



Giallo
Yellow



MESCOLARE
ABBINARE
ALTERNARE
REINTERPRETARE
CONTEMPORANEA
ALTERNATIVA
E RICCA DI DETTAGLI.
MATERIALI E FINITURE
DEFINISCONO SPAZI IN
CONTINUA EVOLUZIONE.

MIX
MATCH
ALTERNATE
REVAMP
contemporary
alternative
and full of details.
Materials and finishes
define constantly
evolving spaces.





Alevè Lux laccato lucido UV
glossy lacquered UV



Malta bordo bicolore
bicolor edge Ardesia bordo bicolore
bicolor edge

Alevè Decor laminato
laminated



Olmo Mercurio bordo in tinta
Mercury Elm edge matching

Laccato opaco
matt lacquered



Giallo
Yellow





Composizione 03_ L1 307 L2 305 cm.

Colonne e pensili Eclettica in vetro colorato opaco grigio piombo. Basi Alevè Decor laminato Argilla bordo in tinta. / Eclettica wall units and column units in lead gray matt glass. Alevè Decor laminate base units Clay edge to match.



Composizione 03_ L1 307 L2 305 cm.

Colonne e pensili Eclettica in vetro colorato opaco grigio piombo. Basi AleVè Decor laminato Argilla bordo in tinta. / Eclettica wall units and column units in lead gray matt glass. AleVè Decor laminate base units Clay edge to match.

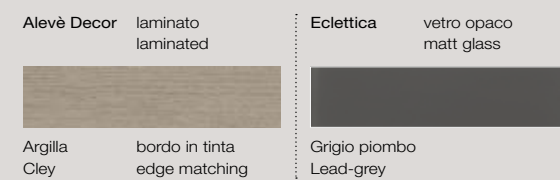

ARMONIA DEI COLORI
TRA LA NUOVA FINITURA
LEGNO NOCE BRONZE,
IL ROVERE ALASKA CON
EFFETTO INVECCHIATO
ED IL LAMINATO
IRIDESCENTE VERDE
BRONZO.

FINITURE ROBUSTE
E A FORTE POTERE
DECORATIVO.

Harmony of colours
among the new bronze
walnut wood, Alaska oak
with an aged effect
and the iridescent
bronze-green laminate.
Robust colours
with strong
decorative potential.

Composizione 03

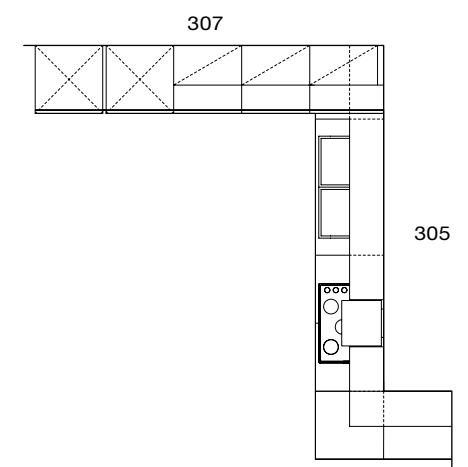

120





Composizione 04_ L1 594 L2 487 cm.

Colonne e mensole Alevè Decor laminato Olmo Mercurio bordo in tinta. Basi e basi sospese Alevè Lux laccato Arena bordo bicolore. Pensile Eclettica in vetro colorato opaco grigio piombo. Elementi a giorno Alevè Decor laminato Olmo Mercurio bordo in tinta, Life laccato opaco perla e laccato opaco piombo. / Alevè Decor laminate column units and shelves Mercury Elm edge to match. Alevè Lux lacquered base units and suspended base units Arena edge bicolor. Eclettica wall unit in lead gray matt glass. Alevè Decor laminate open compartment elements Mercury Elm edge to match, matt pearl lacquered and matt lead gray lacquered Life.

SOLUZIONI COMPOSITE

COMPOSITION SOLUTIONS



Composizione 04_ L1 594 L2 487 cm.
 Colonne e mensole Alevè Decor laminato Olmo Mercurio bordo in tinta. Basi e basi sospese Alevè Lux laccato Arena bordo bicolore. Pensile Eclettica in vetro colorato opaco grigio piombo. Elementi a giorno Alevè Decor laminato Olmo Mercurio bordo in tinta, Life laccato opaco perla e laccato opaco piombo. / Alevè Decor laminate column units and shelves Mercury Elm edge to match. Alevè Lux lacquered base units and suspended base units Arena edge bicolor. Eclettica wall unit in lead gray matt glass. Alevè Decor laminate open compartment elements Mercury Elm edge to match, matt pearl lacquered and matt lead gray lacquered Life.

Composizione 04



594

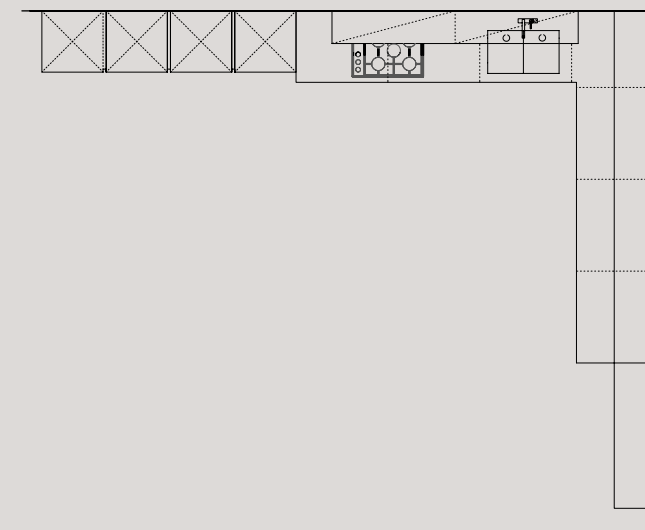

487

Alevè Lux	laccato lucido UV glossy lacquered UV	Alevè Decor	laminato laminated	Eclettica	vetro opaco matt glass
Arena	bordo bicolore bicolor edge	Olmo Mercurio	bordo in tinta Mercury Elm edge in match	Grigio piombo	Lead-grey
	Laccato opaco matt lacquered				
	Madreperla Mother of pearl			Grigio piombo	Lead-grey



Composizione 05_ L 390 cm. Colonne L 219 cm.

Basi in laccato opaco diretto Ice con inserti cassetti in laminato Olmo Crystal. Colonne in laminato Olmo Crystal con inserto elemento Tetris in laccato opaco diretto Ice. /
Directly varnished, matt Ice bases with Crystal Olmo laminate drawers inserted. Crystal Olmo laminate tall units with directly varnished, matt Ice Tetris elements inserted.

ALLINEAMENTI PERFETTI

DECORATIVE ELEMENTS

LUCIDITÀ DI UNA LACCA SUBLIME E FRESCHEZZA ESTREMA FIRMANO L'EFFETTO GLAMOUR DI QUESTA COMPOSIZIONE LA CUI ELEGANZA STA NELLA SEMPLICITÀ E NEGLI ALLINEAMENTI PERFETTI, SENZA CHE LE MANIGLIE VENGANO A ROMPERE LA PUREZZA DELLE SUE LINEE.

Brightness of a sublime loftiness and extreme freshness are what make this arrangement glamorous, whose elegance lies in the simplicity and perfect alignment without having the handles interrupt its pure lines.



Composizione 05_ L 390 cm. Colonne L 219 cm.
 Basi in laccato opaco diretto Ice con inserti cassetti in laminato Olmo Crystal. Colonne in laminato Olmo Crystal con inserto elemento Tetris in laccato opaco diretto Ice. /
 Directly varnished, matt Ice bases with Crystal Olmo laminate drawers inserted. Crystal Olmo laminate tall units with directly varnished, matt Ice Tetris elements inserted.

Diretto	laccato opaco matt lacquered	Alevè Decor	laminato laminated
Ice		Olmo Crystal	bordo in tinta Crystal Elm edge matching

Composizione 05



390

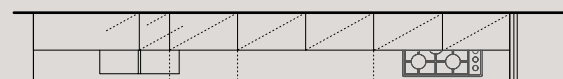

219



Con la **MANIGLIA** l'anta si caratterizza

With the **HANDLE** the door is characterized



MANIGLIA HANDLE

La maniglia oltre alla sua naturale funzione di apertura dell'anta, serve anche a dare un certo carattere alla cucina. **È un dettaglio importante** che può dare un'impronta decisiva alla composizione.

In addition to its normal function of opening the door, the handle also gives the kitchen a certain flair.

It is an important detail that can give a decisive look to the arrangement.

Maniglia opzionale consigliata Optional handle recommended

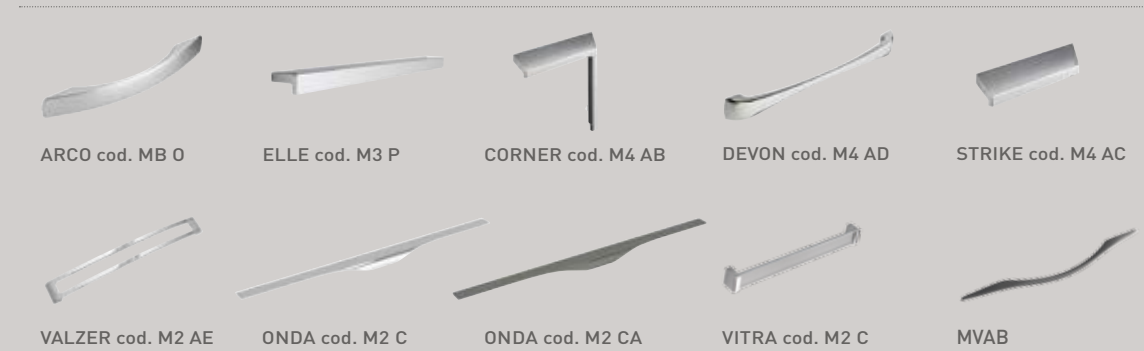

Maniglia di serie Standard handle



Maniglia a richiesta On-demand handle





Composizione 06_L 485 P 270 cm.

Basi in finitura laccato opaco diretto Ice e AleVè Decor laminato Argilla. Elementi Tetris in finitura laccato opaco Piombo con ante in finitura AleVè Decor laminato Argilla. Colonne in finitura AleVè Decor laminato Argilla. / Glossy, direct varnished matt Ice and AleVè Decor Cley laminated bases. Matt varnish finished Tetris Lead-coloured elements with AleVè Decor Cley laminate finished doors. AleVè Decor Cley laminate finished tall units.



FACILE, CON UN SEMPLICE GESTO L'ANTA SCORRE, CHIUDE, APRE QUANTO VUOI.
Easy, with a simple movement the door slides, closes and opens whenever you want.

Composizione 06

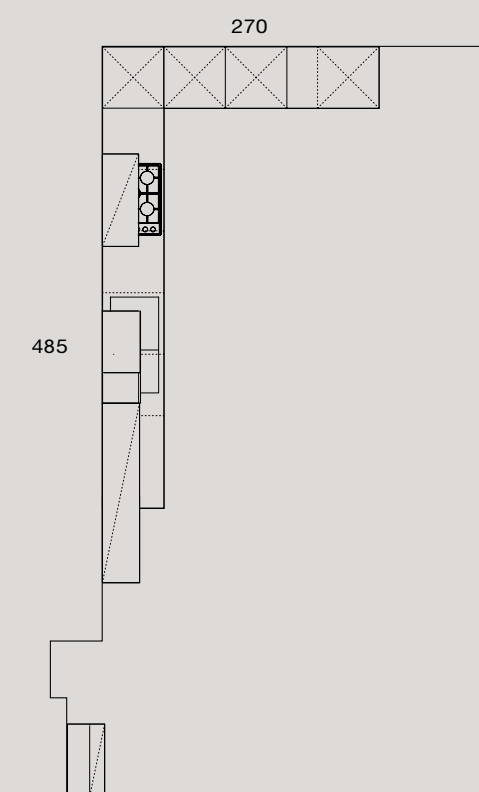

Diretto	laccato opaco matt lacquered	Argilla Cley	laminato laminated	bordo in tinta edge matching
Ice				
Laccato opaco				
Piombo				





QUANTO SPAZIO VUOI

ALL THE SPACE YOU WANT

LO SPAZIO NON È MAI ABBASTANZA, OGNI COSA TROVA IL SUO SPAZIO, IL GIUSTO POSTO, PERCHÈ L'ORDINE È INDISPENSABILE!

You never have enough space, everything finds its own space, the right place, because order is indispensable!



Composizione 06_ L 485 P 270 cm.

Basi in finitura laccato opaco diretto Ice e Alevè Decor laminato Argilla. Elementi Tetris in finitura laccato opaco Piombo con ante in finitura Alevè Decor laminato Argilla. Colonne in finitura Alevè Decor laminato Argilla. / Glossy, direct varnished matt Ice and Alevè Decor Cley laminated bases. Matt varnish finished Tetris Lead-coloured elements with Alevè Decor Cley laminate finished doors. Alevè Decor Cley laminate finished tall units.

Diretto	laccato opaco matt lacquered	Alevè Decor	laminato laminated	Laccato opaco	Matt lacquered
Ice		Argilla		Piombo	
Ice		Cley	bordo in tinta edge matching	Lead	





Composizione 07_ L1 330 Colonne 270 cm Living 270 cm.
Basi in finitura laccato lucido diretto Fango, colonne e pensili in laccato opaco Frost. Elementi Tetris per colonna in finitura laccato opaco Frost, elementi Tetris per pensili in laminato Argilla.
Zona Living in laminato Argilla con pensili in laccato Frost opaco. Elementi Liberty in Fenix come piano. / Glossy, direct varnish finished Mud bases, matt varnished Frost tall units and wall units.
Tetris elements for matt varnish finished Frost tall unit, Tetris elements for Clay laminated wall units. Clay laminated living room area with matt varnished Frost wall units. Liberty elements in Fenix as shelves.





FUNZIONALE,
UNA COMPOSIZIONE
GIOVANE, FACILE
E BEN ACCESSORIATA.
Functional,
a youthful
arrangement, easy
and well accessorised.

Composizione 07_ L1 330 Colonne 270 cm Living 270 cm.
Basi in finitura laccato lucido diretto Fango, colonne e pensili in laccato opaco Frost. Elementi Tetris per colonna in finitura laccato opaco Frost, elementi Tetris per pensili in laminato Argilla. Zona Living in laminato Argilla con pensili in laccato Frost opaco. Elementi Liberty in Fenix come piano. / Glossy, direct varnish finished Mud bases, matt varnished Frost tall units and wall units. Tetris elements for matt varnish finished Frost tall unit, Tetris elements for Clay laminated wall units. Clay laminated living room area with matt varnished Frost wall units. Liberty elements in Fenix as shelves.

Composizione 07

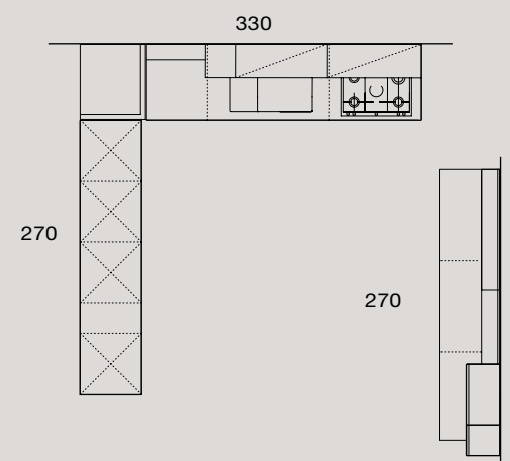

Diretto	laccato lucido Glossy lacquered	Diretto	laccato opaco Matt lacquered	Alevè Decor	laminato laminated
Fango Mud		Frost Frost		Argilla Clay	bordo in tinta edge matching





Composizione 07_ L1 330 Colonne 270 cm Living 270 cm.

Basi in finitura laccato lucido diretto Fango, colonne e pensili in laccato opaco Frost. Elementi Tetris per colonna in finitura laccato opaco Frost, elementi Tetris per pensili in laminato Argilla. Zona Living in laminato Argilla con pensili in laccato Frost opaco. Elementi Liberty in Fenix come piano. / Glossy, direct varnish finished Mud bases, matt varnished Frost tall units and wall units. Tetris elements for matt varnish finished Frost tall unit, Tetris elements for Clay laminated wall units. Clay laminated living room area with matt varnished Frost wall units. Liberty elements in Fenix as shelves.

Diretto	laccato lucido Glossy lacquered	Diretto	laccato opaco Matt lacquered	Alevè Decor	laminato laminated
					
Fango		Frost		Argilla	
Mud		Frost		Clay	





Composizione 08_ L1 420 L2 240 cm. Colonne L 210 cm.
Basi in finitura laccato diretto opaco Fango con maniglia MVAB colore titanio bronzo. Pensile da 120, elementi tretris e penisola in finitura Aleve Decor laminato Olmo Mercurio bardo in tinta.. Pensili e colonne in finitura laccato diretto opaco Creta.





VOLUMI DEFINITI

DEFINED VOLUMES



Composizione 08_ L1 420 L2 240 cm. Colonne L 210 cm.
 Basi in finitura laccato diretto opaco Fango con maniglia MVAB colore titanio bronzo. Pensile da 120, elementi tretris e penisola in finitura Alevè Decor laminato Olmo Mercurio bordo in tinta. Pensili e colonne in finitura laccato diretto opaco Creta.

Diretto	laccato opaco matt lacquered	Alevè Decor	laminato laminated
			
Fango Mud	Creta Clay	Olmo Mercurio bordo in tinta edge in matching	

Composizione 08

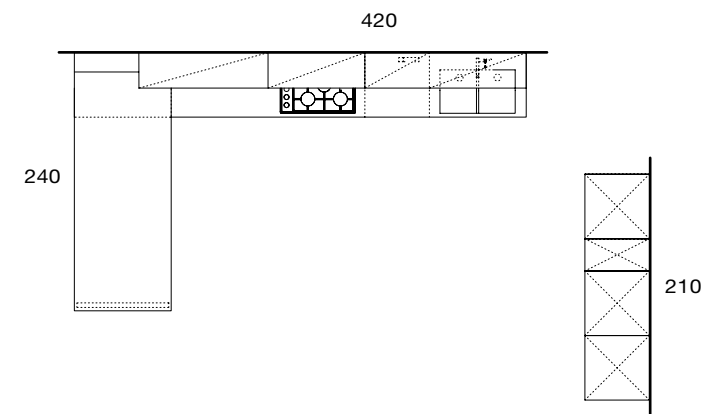



Composizione 09_ L1 276 L2 Penisola 241 cm. Colonne L 274 cm.

Basi in finitura laminato Argilla con maniglia Onda, pensili in finitura laccato Ice lucido con inserti in laminato Argilla. Colonne in finitura laccato Ice lucido diretto. Elementi Tetris in finitura laccato opaco verde Malva. / Laminated finish Clay bases with Onda handle, glossy varnish finished Ice wall units with Clay laminated inlays. Glossy, Ice directly varnished tall units. Tetris elements in varnished matt green Mauve finish.



Composizione 09_ L1 276 L2 Penisola 241 cm. Colonne L 274 cm.
 Basi in finitura laminato Argilla con maniglia Onda, pensili in finitura laccato Ice lucido con inserti in laminato Argilla. Colonne in finitura laccato Ice lucido diretto. Elementi Tetris in finitura laccato opaco verde Malva. /
 Laminated finish Clay bases with Onda handle, glossy varnish finished Ice wall units with Clay laminated inlays. Glossy, Ice directly varnished tall units. Tetris elements in varnished matt green Mauve finish.

Composizione 09

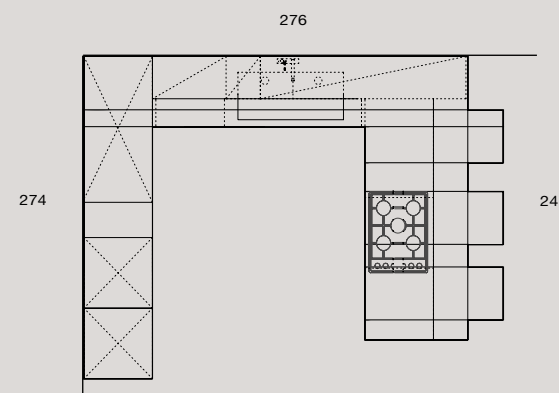



ACCENTI DI COLORE

COLOUR ACCENTS

ACCENTI DI COLORE INTERROMPONO E CARATTERIZZANO L'EQUILIBRIO DI FINITURE NEUTRE GIOCANDO CON SPAZI E VOLUMI. Colour accents break in and characterise the equilibrium of neutral finishes playing on spaces and volumes.



Composizione 09_ L1 276 L2 Penisola 241 cm. Colonne L 274 cm.

Basi in finitura laminato Argilla con maniglia Onda, pensili in finitura laccato Ice lucido con inserti in laminato Argilla. Colonne in finitura laccato Ice lucido diretto. Elementi Tetris in finitura laccato opaco verde Malva. / Laminated finish Clay bases with Onda handle, glossy varnish finished Ice wall units with Clay laminated inlays. Glossy, Ice directly varnished tall units. Tetris elements in varnished matt green Mauve finish.

Alevè Decor	laminato laminated	Diretto	laccato lucido glossy lacquered	Laccato opaco	Matt lacquered
	Argilla		Ice Ice		Malva Mauve
	bordo in tinta edge matching				



Composizione 10_ L 524 P 240 cm.

Basi Alevè Lux laccato lucido UV Ardesia bordo bicolore con maniglia Bridge. Pensili Alevè Lux laccato lucido UV Neve bordo bicolore. Pensili a giorno Alevè Decor laminato Olmo Mercurio bordo in tinta. Top e schienale Eclettica Kerlite Beige. Piano tavolo a penisola in finitura Olmo Mercurio. Colonne Alevè Lux laccato lucido UV Neve bordo bicolore e fianco terminale a giorno Alevè Decor laminato Olmo Mercurio bordo in tinta. / UV Ardesia gloss lacquered Alevè Lux base units, two-tone edge with Bridge handle. UV Neve gloss lacquered Alevè Lux wall units with two-tone edge. Alevè Decor open wall units in Olmo Mercurio laminate with edge in matching colour. Top and back panel in Beige Eclettica Kerlite. Breakfast bar top with Olmo Mercurio finish. UV Neve gloss lacquered Alevè Lux tall units with two-tone edge and Alevè Decor open end panel, Olmo Mercurio laminate with edge in matching colour.

INCONTRO DI STILI

MEETING OF STYLES



Composizione 10_ L 524 P 240 cm.

Basi Alevè Lux laccato lucido UV Ardesia bordo bicolore con maniglia Bridge. Pensili Alevè Lux laccato lucido UV Neve bordo bicolore. Pensili a giorno Alevè Decor laminato Olmo Mercurio bordo in tinta. Top e schienale Eclettica Kerlite Beige. Piano tavolo a penisola in finitura Olmo Mercurio. Colonne Alevè Lux laccato lucido UV Neve bordo bicolore e fianco terminale a giorno Alevè Decor laminato Olmo Mercurio bordo in tinta. / UV Ardesia gloss lacquered Alevè Lux base units, two-tone edge with Bridge handle. UV Neve gloss lacquered Alevè Lux wall units with two-tone edge. Alevè Decor open wall units in Olmo Mercurio laminate with edge in matching colour. Top and back panel in Beige Eclettica Kerlite. Breakfast bar top with Olmo Mercurio finish. UV Neve gloss lacquered Alevè Lux tall units with two-tone edge and Alevè Decor open end panel, Olmo Mercurio laminate with edge in matching colour.

Composizione 10

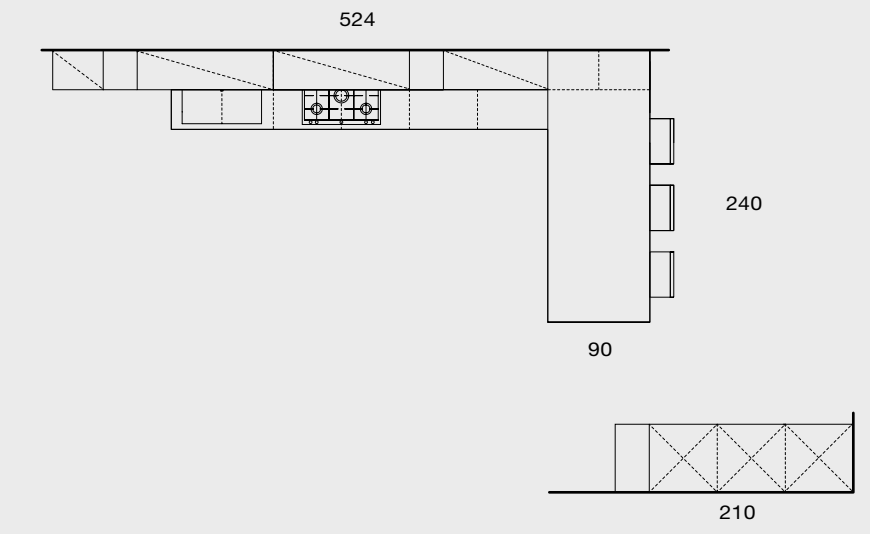

Alevè Lux laccato lucido UV glossy lacquered UV	Alevè Decor laminato laminated
 Ardesia Slate	 Neve Snow
 bordo bicolore bicolor edge	 bordo bicolore bicolor edge
 Olmo Mercurio Mercury Elm	 bordo in tinta edge matching





Composizione 10_ L 524 P 240 cm.

Basi Alevè Lux laccato lucido UV Ardesia bordo bicolore con maniglia Bridge. Pensili Alevè Lux laccato lucido UV Neve bordo bicolore. Pensili a giorno Alevè Decor laminato Olmo Mercurio bordo in tinta. Top e schienale Eclettica Kerlite Beige. Piano tavolo a penisola in finitura Olmo Mercurio. Colonne Alevè Lux laccato lucido UV Neve bordo bicolore e fianco terminale a giorno Alevè Decor laminato Olmo Mercurio bordo in tinta. / UV Ardesia gloss lacquered Alevè Lux base units, two-tone edge with Bridge handle. UV Neve gloss lacquered Alevè Lux wall units with two-tone edge. Alevè Decor open wall units in Olmo Mercurio laminate with edge in matching colour. Top and back panel in Beige Eclettica Kerlite. Breakfast bar top with Olmo Mercurio finish. UV Neve gloss lacquered Alevè Lux tall units with two-tone edge and Alevè Decor open end panel, Olmo Mercurio laminate with edge in matching colour.

Alevè Lux	laccato lucido UV glossy lacquered UV		
Ardesia	bordo bicolore bicolor edge		
Neve	bordo bicolore bicolor edge		
.....			
Alevè Decor	laminato laminated		
Olmo Mercurio Mercury Elm	bordo in tinta edge matching		





Composizione 11_ L 645 P 360 cm.

Basi e pensili Alevè Decor laminato Olmo Crystal bordo in tinta con maniglia Vitra. Pensili Eclettica vetro opaco Bianco. Pensili a giorno laccato opaco Bianco. Top e schienale laminato opaco Bianco. Piano tavolo a penisola in finitura Olmo Crystal. Colonne Alevè Decor laminato Olmo Crystal bordo in tinta e vani a giorno laccato opaco Bianco. Alevè Decor base and wall units in Olmo Crystal laminate with edge in matching colour with Vitra handle. Eclettica wall units in Bianco matte glass. Bianco matte lacquered open wall units. Top and back panel in Bianco matte laminate. Breakfast bar top with Olmo Crystal finish. Alevè Decor tall units in Olmo Crystal laminate with edge in matching colour and Bianco e matte lacquered open compartments.



Composizione 11_L 645 P 360 cm.

Basi e pensili Alevè Decor laminato Olmo Crystal bordo in tinta con maniglia Vitra. Pensili Eclettica vetro opaco Bianco. Piano tavolo a penisola in finitura Olmo Crystal. Colonne Alevè Decor laminato Olmo Crystal bordo in tinta e vani a giorno laccato opaco Bianco. Alevè Decor base and wall units in Olmo Crystal laminate with edge in matching colour with Vitra handle. Eclettica wall units in Bianco matte glass. Bianco matte lacquered open wall units. Top and back panel in Bianco matte laminate. Breakfast bar top with Olmo Crystal finish. Alevè Decor tall units in Olmo Crystal laminate with edge in matching colour and Bianco e matte lacquered open compartments.

Composizione 11 

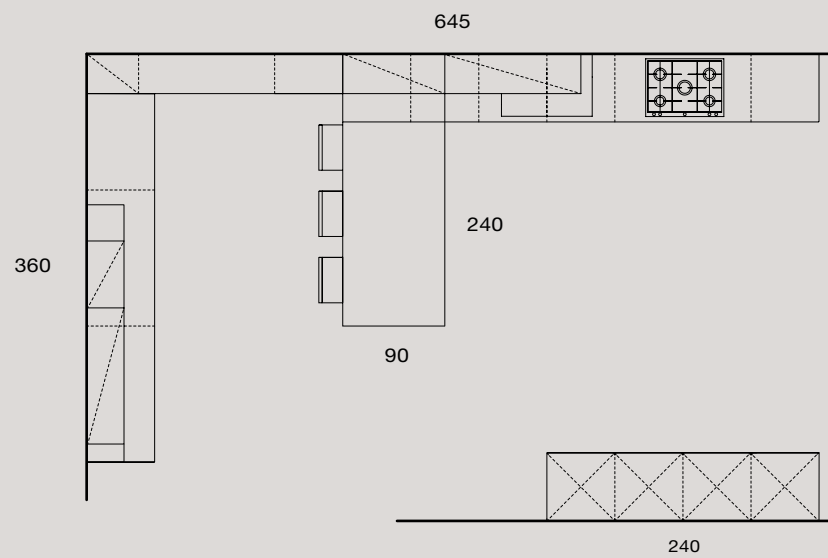

		
Alevè Decor laminato laminated	Eclettica vetro opaco matt glass	Laccato opaco Matt lacquered
Olmo Crystal bordo in tinta Crystal Elm edge matching	Bianco White	Bianco White





Composizione 11_ L 482 P 245 cm.

Basi Alevè Lux laccato lucido UV Neve bordo bicolore con maniglia in testa all'anta Onda. Pensili Alevè Lux laccato lucido UV Ardesia e Arena bordo bicolore. Pensili a giorno Laccato opaco Bianco. Top e schienale Kerlite Ardesia. Colonne Alevè Lux laccato lucido UV Arena bordo bicolore e vani a giorno laccato opaco Bianco. / UV Neve gloss lacquered Alevè Lux base units with two-tone edge and Onda handle at the top of the door. UV Ardesia and Arena gloss lacquered. Alevè Lux wall units with two-tone edge. Bianco matte lacquered open wall units. Top and back panel in Kerlite Ardesia. UV Arena gloss lacquered Alevè Lux tall units with two-tone edge and Bianco matte lacquered open compartments.



Composizione 12_ L 482 P 245 cm.



Basi Alevè Lux laccato lucido UV Neve bordo bicolore con maniglia in testa all'anta Onda. Pensili Alevè Lux laccato lucido UV Ardesia e Arena bordo bicolore. Pensili a giorno Laccato opaco Bianco. Top e schienale Kerlite Ardesia. Colonne Alevè Lux laccato lucido UV Arena bordo bicolore e vani a giorno laccato opaco Bianco. / UV Neve gloss lacquered Alevè Lux base units with two-tone edge and Onda handle at the top of the door. UV Ardesia and Arena gloss lacquered. Alevè Lux wall units with two-tone edge. Bianco matte lacquered open wall units. Top and back panel in Kerlite Ardesia. UV Arena gloss lacquered Alevè Lux tall units with two-tone edge and Bianco matte lacquered open compartments.

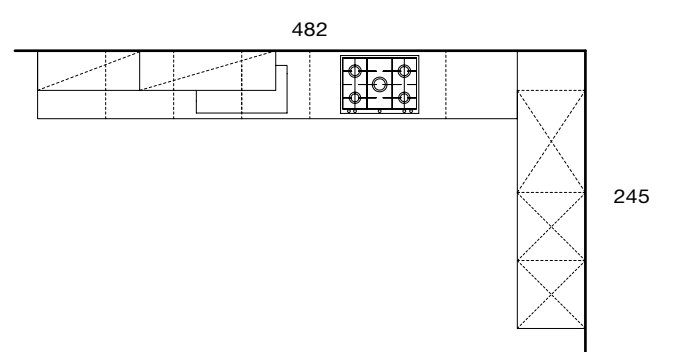

Composizione 12 

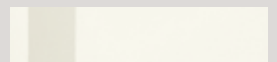
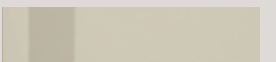
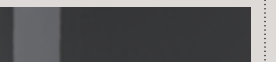

Composizione 12_ L 482 P 245 cm.
 Basi Alevè Lux laccato lucido UV Neve bordo bicolore con maniglia in testa all'anta Onda. Pensili Alevè Lux laccato lucido UV Ardesia e Arena bordo bicolore. Pensili a giorno Laccato opaco Bianco. Top e schienale Kerlite Ardesia. Colonne Alevè Lux laccato lucido UV Arena bordo bicolore e vani a giorno laccato opaco Bianco. / UV Neve gloss lacquered Alevè Lux base units with two-tone edge and Onda handle at the top of the door. UV Ardesia and Arena gloss lacquered. Alevè Lux wall units with two-tone edge. Bianco matte lacquered open wall units. Top and back panel in Kerlite Ardesia. UV Arena gloss lacquered Alevè Lux tall units with two-tone edge and Bianco matte lacquered open compartments.

			
Neve Snow	Arena Arena	Ardesia Slate	Bianco White
Alevè Lux laccato lucido UV glossy lacquered UV		Laccato opaco Matt lacquered	
bordo bicolore bicolor edge	bordo bicolore bicolor edge	bordo bicolore bicolor edge	

Composizione 13_ L 510 P 60 cm.

Basi Alevè Decor laminato Olmo Crystal bordo in tinta con maniglia in testa all'anta Onda. Pensili Eclettica vetro lucido Bianco. Pensili a giorno Alevè Decor laminato Olmo Crystal. Top e schienale in acciaio lucido. Colonne Alevè Decor laminato Olmo Crystal bordo in tinta. / Alevè Decor base units in Olmo Crystal laminate with edge in matching colour and Onda handle at the top of the door. Eclettica wall units in Bianco gloss glass. Alevè Decor open wall units in Olmo Crystal laminate. Top and back panel in gloss steel. Alevè Decor tall units in Olmo Crystal laminate with edge in matching colour.

Composizione 13

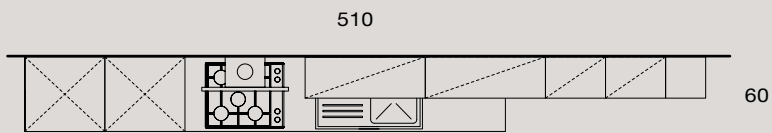

Alevè Decor	laminato laminated	Alevè Lux	laccato lucido UV glossy lacquered UV
	Olmo Crystal Crystal Elm		Neve Snow
	bordo in tinta edge matching		bordo bicolor bicolor edge







Composizione 14_ L 510 P 225 cm.

Basi Alevè Lux laccato lucido UV Neve bordo bicolore con maniglia Bridge. Vano a giorno, pensili e colonne Alevè Decor laminato Olmo Mercurio bordo in tinta. Pensile a giorno laccato opaco Giallo. Top e schienale laminato opaco bianco. / UV Neve gloss lacquered Alevè Lux base units, two-tone edge with Bridge handle. Alevè Decor open compartments, wall units and tall units in Olmo Mercurio laminate with edge in matching colour. Giallo matte lacquered open wall unit. Top and back panel in Bianco matte laminate.

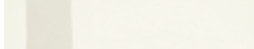

Composizione 14_L 510 P 225 cm.

Basi Alevè Lux laccato lucido UV Neve bordo bicolore con maniglia Bridge. Vano a giorno, pensili e colonne Alevè Decor laminato Olmo Mercurio bordo in tinta. Pensile a giorno laccato opaco Giallo. Top e schienale laminato opaco bianco. / UV Neve gloss lacquered Alevè Lux base units, two-tone edge with Bridge handle. Alevè Decor open compartments, wall units and tall units in Olmo Mercurio laminate with edge in matching colour. Giallo matte lacquered open wall unit. Top and back panel in Bianco matte laminate.

		
Alevè Lux laccato lucido UV glossy lacquered UV	Alevè Decor laminato laminated	Laccato opaco Matt lacquered
Neve bordo bicolore Snow bicolor edge	Olmo Mercurio bordo in tinta Mercury Elm edge matching	Giallo Yellow

Composizione 14 

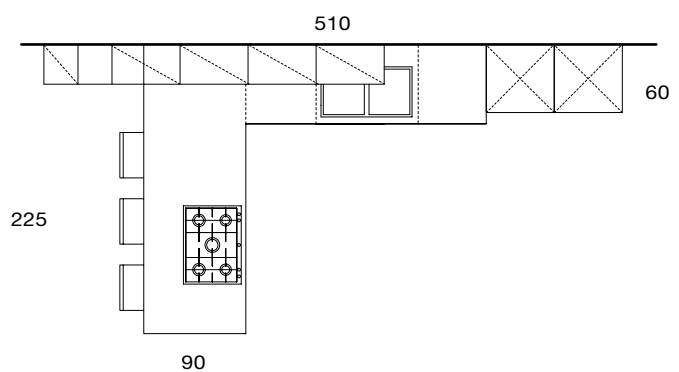



Composizione 15_ L 420 P 60 cm.

Basi Alevè Lux laccato lucido UV Ardesia bordo bicolor con maniglia Bridge. Pensili Alevè Decor laminato Argilla bordo in tinta. Pensili a giorno laccato opaco Bianco. Top e schienale in quarzo spacco nero. Colonne Alevè Lux laccato lucido UV Neve bordo bicolor con maniglia Bridge, vano a giorno Alevè Decor laminato Argilla bordo in tinta. / UV Ardesia gloss lacquered Alevè Lux base units, two-tone edge with Bridge handle. Alevè Decor wall units in Argilla laminate and edge in matching colour. Bianco matte lacquered open wall units. Top and back panel in spacco nero quartz. UV Neve gloss lacquered Alevè Lux tall units, two-tone edge with Bridge handle, Alevè Decor open compartment in Argilla laminate with edge in matching colour.

Composizione 15 

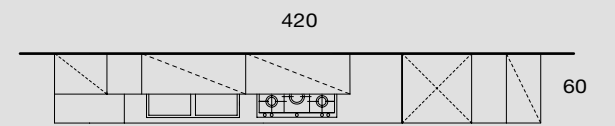

Alevè Lux laccato lucido UV
glossy lacquered UV

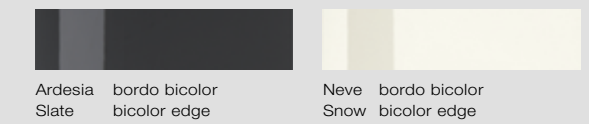

Alevè Decor laminato
laminated



Composizione 01 page 10



- | | | |
|-----------|---------------------------------|--|
| Diretto | laccato lucido glossy lacquered | |
| Fango Mud | Oliva Olive | |

Composizione 05 page 32



- | | | | |
|---------|------------------------------|--------------------------|------------------------------|
| Diretto | laccato opaco matt lacquered | Alevè Decor | laminato laminated |
| Ice | Ice | Olmo Crystal Crystal Elm | bordo in tinta edge matching |

Composizione 09 page 62



- | | | | | |
|--------------|------------------------------|---------|---------------------------------|------------------------------|
| Alevè Decor | laminato laminated | Diretto | laccato lucido glossy lacquered | Laccato opaco Matt lacquered |
| Argilla Clay | bordo in tinta edge matching | Ice | Ice | Malva Mauve |

Composizione 13 page 84



- | | | | |
|-----------|---------------------------------------|--------------------------|------------------------------|
| Alevè Lux | laccato lucido UV glossy lacquered UV | Alevè Decor | laminato laminated |
| Neve Snow | bordo bicolor bicolor edge | Olmo Crystal Crystal Elm | bordo in tinta edge matching |

Composizione 02 page 16



- | | | | | |
|-----------|---------------------------------------|---------------|----------------------------|------------------------------|
| Alevè Lux | laccato lucido UV glossy lacquered UV | Alevè Decor | laminato laminated | Laccato opaco Matt lacquered |
| Malta | bordo bicolor bicolor edge | Ardesia Slate | bordo bicolor bicolor edge | Olmo Mercurio Mercury Elm |
| | | | | Giallo Yellow |

Composizione 06 page 38



- | | | | | |
|---------|------------------------------|--------------|------------------------------|------------------------------|
| Diretto | laccato opaco matt lacquered | Alevè Decor | laminato laminated | Laccato opaco Matt lacquered |
| Ice | Ice | Argilla Clay | bordo in tinta edge matching | Piombo Lead |

Composizione 10 page 68



- | | | | | |
|---------------|---------------------------------------|-------------|----------------------------|------------------------------|
| Alevè Lux | laccato lucido UV glossy lacquered UV | Alevè Decor | laminato laminated | |
| Ardesia Slate | bordo bicolor two-tone edge | Neve Snow | bordo bicolor bicolor edge | Olmo Mercurio Mercury Elm |
| | | | | bordo in tinta edge matching |

Composizione 14 page 86



- | | | | | |
|-----------|---------------------------------------|---------------------------|------------------------------|------------------------------|
| Alevè Lux | laccato lucido UV glossy lacquered UV | Alevè Decor | laminato laminated | Laccato opaco Matt lacquered |
| Neve Snow | bordo bicolor bicolor edge | Olmo Mercurio Mercury Elm | bordo in tinta edge matching | Giallo Yellow |

Composizione 03 page 24



- | | | | |
|--------------|------------------------------|-------------------------|------------------------|
| Alevè Decor | laminato laminated | Eclettica | vetro opaco matt glass |
| Argilla Clay | bordo in tinta edge matching | Grigio piombo Lead-grey | |

Composizione 07 page 46



- | | | | | | |
|-----------|---------------------------------|--------------|------------------------------|-------------|--------------------|
| Diretto | laccato lucido glossy lacquered | Diretto | laccato opaco matt lacquered | Alevè Decor | laminato laminated |
| Fango Mud | Frost Frost | Argilla Clay | | | |

Composizione 11 page 76



- | | | | | |
|--------------------------|------------------------------|--------------|------------------------|------------------------------|
| Alevè Decor | laminato laminated | Eclettica | vetro opaco matt glass | Laccato opaco Matt lacquered |
| Olmo Crystal Crystal Elm | bordo in tinta edge matching | Bianco White | | Bianco White |

Composizione 15 page 90



- | | | | | |
|---------------|---------------------------------------|-------------|----------------------------|------------------------------|
| Alevè Lux | laccato lucido UV glossy lacquered UV | Alevè Decor | laminato laminated | |
| Ardesia Slate | bordo bicolor bicolor edge | Neve Snow | bordo bicolor bicolor edge | Argilla Clay |
| | | | | bordo in tinta edge matching |

Composizione 04 page 28



- | | | | | | | |
|-----------|---------------------------------------|---------------------------|------------------------------|-------------------------|------------------------|------------------------------|
| Alevè Lux | laccato lucido UV glossy lacquered UV | Alevè Decor | laminato laminated | Eclettica | vetro opaco matt glass | Laccato opaco Matt lacquered |
| Arena | bordo bicolor bicolor edge | Olmo Mercurio Mercury Elm | bordo in tinta edge matching | Grigio piombo Lead-grey | | Madreperla Mother of pearl |
| | | | | | | Grigio piombo Lead-grey |

Composizione 08 page 56



- | | | | |
|-----------|------------------------------|---------------------------|------------------------------|
| Diretto | laccato opaco matt lacquered | Alevè Decor | laminato laminated |
| Fango Mud | Creta Clay | Olmo Mercurio Mercury Elm | bordo in tinta edge matching |

Composizione 12 page 80



- | | | | | | | |
|-----------|---------------------------------------|------------------------------|----------------------------|---------------|----------------------------|--------------|
| Alevè Lux | laccato lucido UV glossy lacquered UV | Laccato opaco Matt lacquered | | | | |
| Neve Snow | bordo bicolor bicolor edge | Arena Arena | bordo bicolor bicolor edge | Ardesia Slate | bordo bicolor bicolor edge | Bianco White |

Alevè

Decor Laminati / Laminated

Spessore anta 23 mm Door thickness 23 mm



Tela bordo in tinta
Canvas edge matching



Argilla bordo in tinta
Clay edge matching



Olmo Mercurio bordo in tinta
Mercury Elm edge matching



Olmo Crystal bordo in tinta
Crystal Elm edge matching

LUX Laccati / Lacquers

Spessore anta 23 mm Door thickness 23 mm



Neve bordo bicolore
Snow bicolor edge



Arena bordo bicolore
Arena bicolor edge

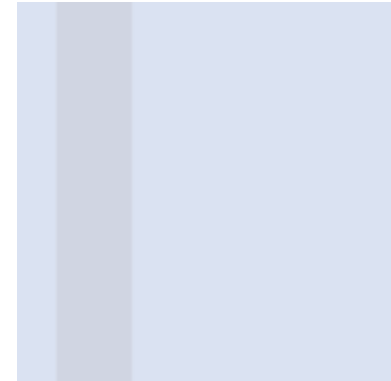

Cielo bordo bicolore
Cielo bicolor edge



Ecreu bordo bicolore
Ecru bicolor edge



Malta bordo bicolore
Malta bicolor edge



Ardesia bordo bicolore
Slate bicolor edge

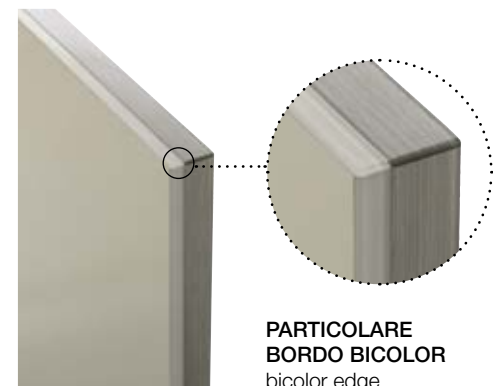

PARTICOLARE BORDO BICOLOR
bicolor edge

Laccati DIRETTI lucidi e opachi / Glossy and matt DIRETTI lacquers

Spessore anta 23 mm Door thickness 23 mm

Di serie / Standard



Ice
Ice

A richiesta / On demand



Monolite
Monolite



Fango
Mud



Oliva
Olive



Nuvola
Cloud



Creta
Clay



Pomice
Pumice



Frost
Frost

Le aperture / Openings

Maniglie / Handles

Maniglia di serie Standard handle



BRIDGE cod. MWA
Maniglia cromo lucido
Glossy chrome handle
Interasse / Drilling centre
96 - 160 - 320 mm

Maniglia a richiesta On-demand handle types



PARIS cod. M4 A
Cromo lucido
Glossy chrome
Interasse / Drilling centre
64 - 160 - 320 mm

Maniglia opzionale consigliata Optional handle recommended



ARCO cod. MB O
Nichel satinato
Satin-finish nickel
Interasse /
Drilling centre
160 - 320 mm



MVAB
Titanio Bronzo
Titanium Bronze
Interasse /
Drilling centre
160 - 320 mm



ELLE cod. M3 P
Cromo lucido
Glossy chrome
Interasse /
Drilling centre
64 - 160 - 320 mm



CORNER cod. M4 AB
Cromo lucido
Glossy chrome
Interasse /
Drilling centre
64 - 160 - 320 mm



DEVON cod. M4 AD
Cromo lucido
Glossy chrome
Interasse /
Drilling centre
64 - 160 - 320 mm

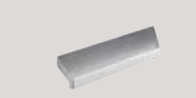

STRIKE cod. M4 AC
Cromo lucido
Glossy chrome
Interasse /
Drilling centre
96 - 192 mm



VALZER cod. M2 AE
Cromo lucido
Glossy chrome
Interasse /
Drilling centre
64 - 160 - 320 mm

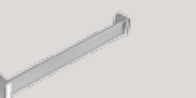

VITRA cod. M3P A
Cromo lucido
Glossy chrome
Interasse /
Drilling centre
64 - 160 - 320 mm



ONDA cod. M2 C
Maniglia brill applicata
in testa all'anta
Interasse modulare
Brill handle
Modular drilling centre



ONDA cod. M2 CA
Maniglia peltro applicata
in testa all'anta
Interasse modulare
Pewter handle
Modular drilling centre

Sistema Gola Groove System



Tasca



Presca Maniglia
Socket Handle

**MAGGIOR
SICUREZZA
MAGGIOR
STABILITÀ**
MORE SAFETY MORE STABILITY

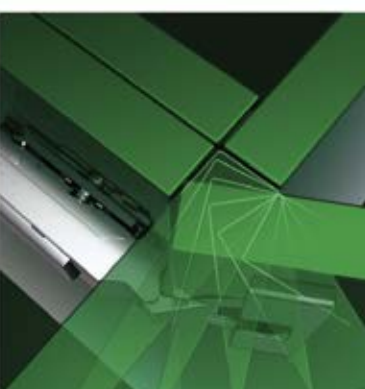
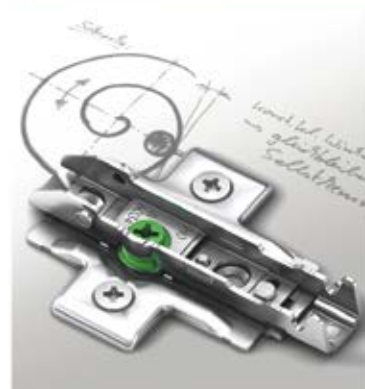

La tripla cerniera conferisce stabilità all'anta e maggior resistenza all'urto.

The triple hinge gives the door stability and greater resistance to slamming.

Stabilità costante in ogni posizione. Regolazione dell'altezza continua ed autobloccante.

Durable stability in every position. Stepless, self-locking height adjustment.

Con o senza frenata integrata. Stesso design per la combinazione di cerniere dotate e prive di Soft-close.

With or without integrated damping. Matching design for combinations of hinges with and without damping.

Maggiore comfort attraverso l'inno-vazione. Grazie al movimento della leva ottimizzato è possibile aprire le ante dei mobili in modo estremamente semplice.

Enhanced comfort thanks to new development. Optimised lever movement enables furniture doors to be opened with extreme ease.

Regolazione della frenata senza utensili. Chiusura uniforme indipendentemente dalle dimensioni e peso dell'anta.

Tool-free damper adjustment. Consistent closing action irrespective of door size and weight.

Design: Adriani e Rossi Edizioni
A. D. e Grafica: Adriani e Rossi Edizioni
Foto: Studio Indoor (Oderzo - TV)
Fotolito: Bieffe VR
Stampa: Eurotipo VR
Stampato in Italia Giugno 2014



STOSA
CUCINE

Stosa S.p.A.

STAB., SEDE AMM.VA E RECAPITO POSTALE:
S.S. Cassia, Km. 149,5
53040 Radicofani (SI) Italy

GPS:
N 42° 53' 50,6"
E 11° 45' 53,5"

INFO:
tel. +39 0578 5711 r.a.
fax +39 0578 50088

INFO LINE:
840 000 691

www.stosa.it

stosa@stosa.it

