

Letti Bolzan®

harmony
for
life

312.321	CEYLON
024.027	COROLLE BOX
018.023	COROLLE H9
234.247	CUBED
284.289	EXIGE
278.283	FREEDOM
270.273	FREEDOM BIG
140.141	GAYA NEW BOX
134.137	GAYA NEW H9
172.173	IORCA BOX
174.178	IORCA CHIC
164.168	IORCA H9
062.067	JACK
046.049	JILL
052.057	JILL BOX
040.041	KATE BOX
032.039	KATE H9
256.261	MAISON
202.211	METROPOLITAN
212.213	METROPOLITAN CHIC
248.255	MIAMI
184.191	MOONITO
192.197	NIDO
108.113	PLAZA
290.293	SELENE BOX
304.305	SELENE EXTRA LARGE
294.297	SELENE H9
298.301	SELENE LARGE
158.163	SMILE
102.103	STEEL BOX
096.099	STEEL LIGHT
220.223	SUN
224.227	SUN CHIC
128.133	TALLIS BOX
118.123	TALLIS H9
076.083	TULIP
072.075	TULIP DOUBLE
090.091	TULIP POOL
086.087	TULIP YOUNG
262.269	VITTORIA
150.157	VOLA
336.341	DUBAI CONTRACT
322.335	FREEDOM CONTRACT
342.345	SELENE CONTRAC



corolle h 9 pag 018.023



corolle box pag 024.027



kate h 9 pag 032.039



kate box pag 040.041



metropolitan chic pag 212.213



sun pag 220.223



sun chic pag 224.227



cubed pag 234.247



jill pag 046.049



jill box pag 052.057



jack pag 062.067



tulip pag 076.083



miami pag 248.255



maison pag 256.261



vittoria pag 262.269



freedom big pag 270.273



tulip double pag 072.075



steel light pag 096.099



steel box pag 102.103



plaza pag 108.113



freedom pag 278.283



exige pag 284.289



selene h9 pag 294.297



selene pag 290.293



tallis h 9 pag 118.123



tallis box pag 128.133



gaya new h 9 pag 134.137



gaya new box pag 140.141



selene large pag 298.301



selene extra large pag 304.305



ceylon pag 312.321



linea contract pag 322.345



vola h 9 pag 150.157



smile pag 158.163



iorca h 9 pag 164.168



iorca box pag 172.173



iorca chic pag 174.178



moonito pag 184.191



nido pag 192.197



metropolitan pag 202.211

L' ALLUMINIO ENTRA NELLA STRUTTURA DEL LETTO

ALUMINUM IN THE STRUCTURE OF THE BED



Bolzan letti è tra le poche aziende ad usare strutture interamente in alluminio, questa scelta deriva da esigenze estetiche, di pulibilità e tecnico-costruttive. L'alluminio è infatti un materiale estremamente facile da pulire, totalmente anallergico e completamente riciclabile, inoltre la sua resistenza alla torsione unita alla sua leggerezza permette soluzioni tecnico-estetiche altrimenti non raggiungibili.

Bolzan letti is one of the few companies which uses structures entirely made of aluminum, this choice comes from aesthetic, cleaning and technical exigencies. Aluminum is in fact a material which is extremely easy to clean, totally anallergic and completely recyclable, besides its resistance to torsion together with its lightness allows technical and aesthetical solutions which could not be reached otherwise.

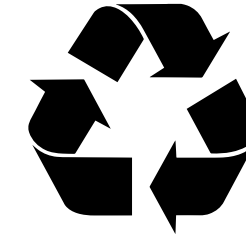
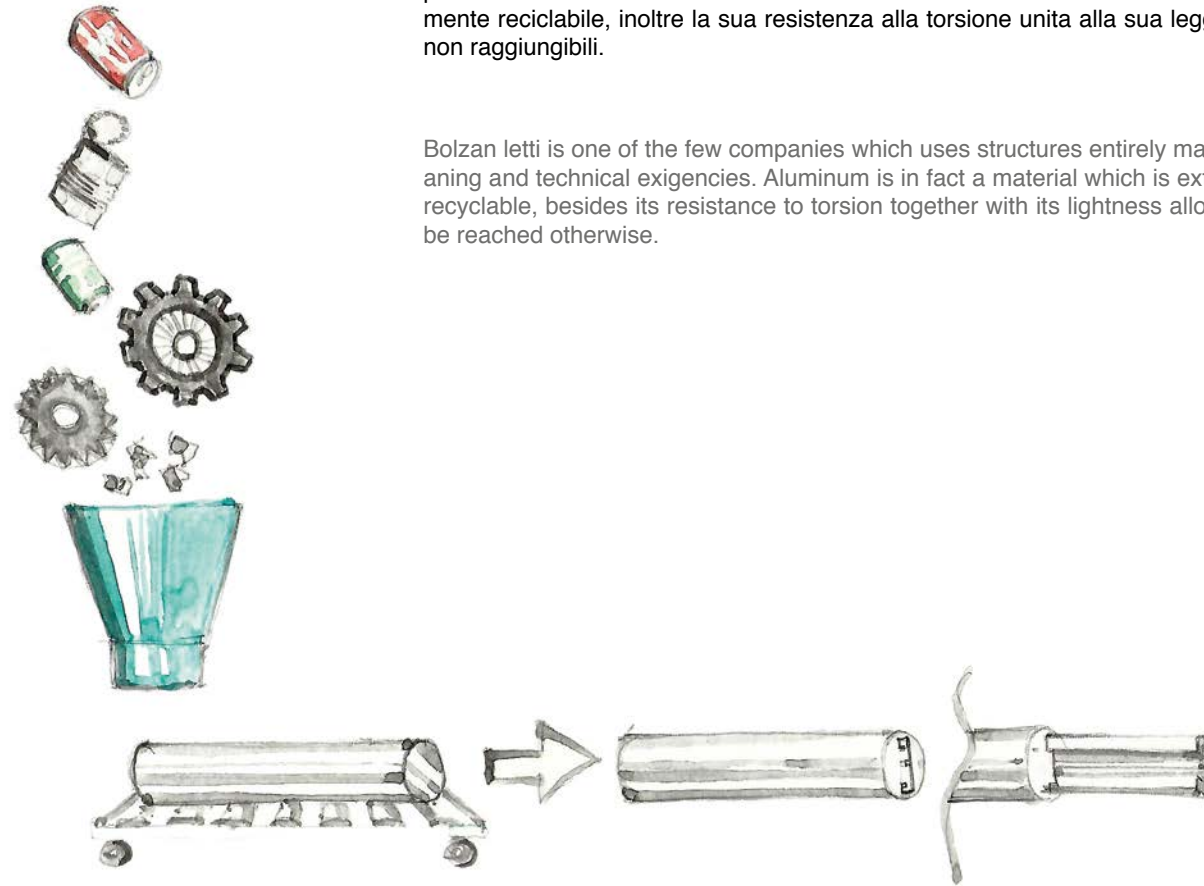

RICICLABILE / RECYCLABLE

Il metallo utilizzato è resistente, leggero, duttile e durevole. Tali caratteristiche non si alterano nel tempo e permettono all'alluminio di essere riciclato infinite volte, senza rischiare la perdita delle qualità originali. Per queste eccellenti qualità l'alluminio è stato definito "materiale verde". L'alluminio può essere rifuso all'infinito con un consumo di energia limitato. L'alluminio pone le basi per una migliore qualità della vita delle generazioni future.

The metal used is resistant, lightweight, ductile and durable. These features do not change over time and allow the aluminum to be recycled infinitely, without risking the loss of original quality. For these excellent qualities, aluminum has been called "green material". Aluminum can be refused infinitely with a limited energy consumption. Aluminum represents the beginning of a better quality of life for future generations.



RESISTENTE AL FUOCO / FIRE RESISTANT

Questo significa che l'alluminio non genera alcuna emissione nociva o pericolosa e che è assolutamente a prova di fuoco, non può in alcun modo propagare incendi né mettere in pericolo vite umane con esalazioni di gas tossici o fumo. L'alluminio non è in nessun modo nocivo per l'ambiente.

This means that aluminum does not produce any harmful or dangerous emissions and is absolutely fire-proof, it can in no way propagate fires or endanger human beings with toxic gasses or fumes. Aluminum is not harmful to the environment in any way.



RIVALUTABILE / REVALUABLE

Poiché non si corrode né si deteriora, gli elementi costruttivi resistono per tutta la vita senza bisogno di manutenzione. La superficie esterna si mantiene sempre come il primo giorno. Oltre alla pulitura non è soggetto a nessun'altra manutenzione. Si pulisce allo stesso modo del vetro. Più l'alluminio viene riciclato, più è economico, in termini energetici, di costo delle materie prime ed ambientali.

As it does not corrode or deteriorate, the structural elements are long life resistant without any maintenance. The outer surface is always as the first day. In addition to cleaning it does not need any other type of maintenance. It can be cleaned in the same way as glass. The more aluminum is recycled, the more economic it is, in terms of energy, cost of raw materials and environment.

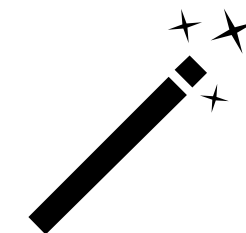

RIVOLUZIONARIO / REVOLUTIONARY

Il cassone in alluminio permette anche l'utilizzo di meccanismi hands free che permettono di alzare la rete senza fatica e senza utilizzare le mani, con anche il massimo utilizzo dello spazio del contenitore.

The aluminum bed frame also allows the use of hands free mechanisms that enable you to easily lift the wooden slat and without using your hands, even with utmost use of the storage space.

QUALITY SYSTEM

L' IMPORTANZA DI UTILIZZARE IL LEGNAME CORRETTO THE IMPORTANCE OF USING THE APPROPRIATE WOOD

CICLO DEL LEGNO CON MARCHIO PEFC PEFC WOOD CYCLE

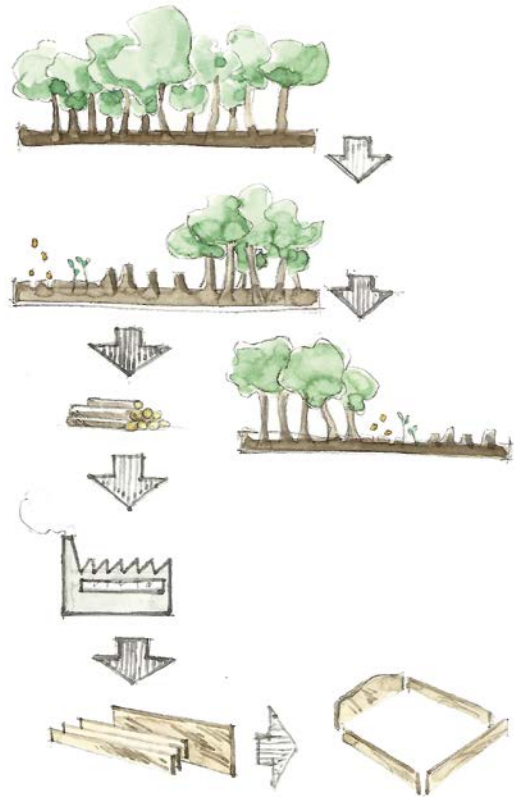

DOVE UTILIZZIAMO IL LEGNO CON MARCHIO PEFC WHERE WE USE PEFC WOOD



GIROLETTO H9, LIGHT, SMILE



GIROLETTO H 29



GIROLETTO H 29 CON BOX SPRING



INTERNO BOX IN LEGNO ABETE

QUALITY SYSTEM



LEGNAME DI RIFORMAZIONE / REFORESTATION WOOD

Tutto il legname proviene da produttori certificati PEFC™, ciò significa che il legno proviene da piantagioni di riforestazione, dove ogni pianta utilizzata viene sostituita da una nuova per non distruggere l'ambiente anzi aumentandone l'apporto di ossigeno all'interno dell'atmosfera.
All wood comes from certified PEFC™ producers, which means that wood comes from reforestation plantations, where every used tree is replaced by a new one to avoid destroying the environment and thus increasing its oxygen supply to the atmosphere.



PRESTAZIONI SUPERIORI / HIGH PERFORMANCES

Per questioni di leggerezza e resistenza in alcuni articoli utilizziamo multistrato di faggio, materiale utilizzato nelle costruzioni edili, navali e aeronautiche. Per le nostre strutture usiamo legno a tre strati che ha prestazioni superiori al legno normale in quanto le fibre vengono intrecciate dando più resistenza in tutte le direzioni. Infatti così facendo non si svergola, non si imbarca e non si fessura come una normale tavola monostrato.

For lightness and strength issues in some items we use beech plywood, a material used in building, naval and aeronautical constructions. For our structures we use a three-layer wood that has higher performances than normal wood, because fibers are interlaced giving it more resistance in all directions. In fact, in this way the wood does not twist, nor bend and does not crack like a normal single-layer board.

LEGNO MONOSTRATO / SINGLE-LAYER WOOD



IMBARCAMENTO / BENDING



IMBARCAMENTO / BENDING



SVERGOLAMENTO / TWISTING

LEGNO MULTISTRATO / MULTILAYER WOOD

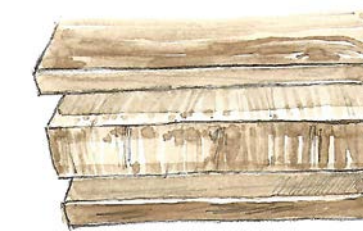

La particolare costruzione di questo pannello evita le problematiche del legno monostrato.
The particular construction of this panel avoids issues of the single-layer wood.

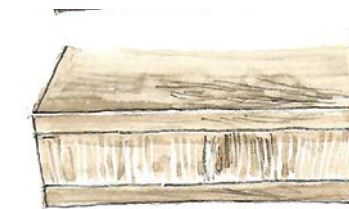

QUALITY SYSTEM

LA GOMMAPIUMA FOAM RUBBER

CICLO DELLA GOMMAPIUMA FOAM CYCLE

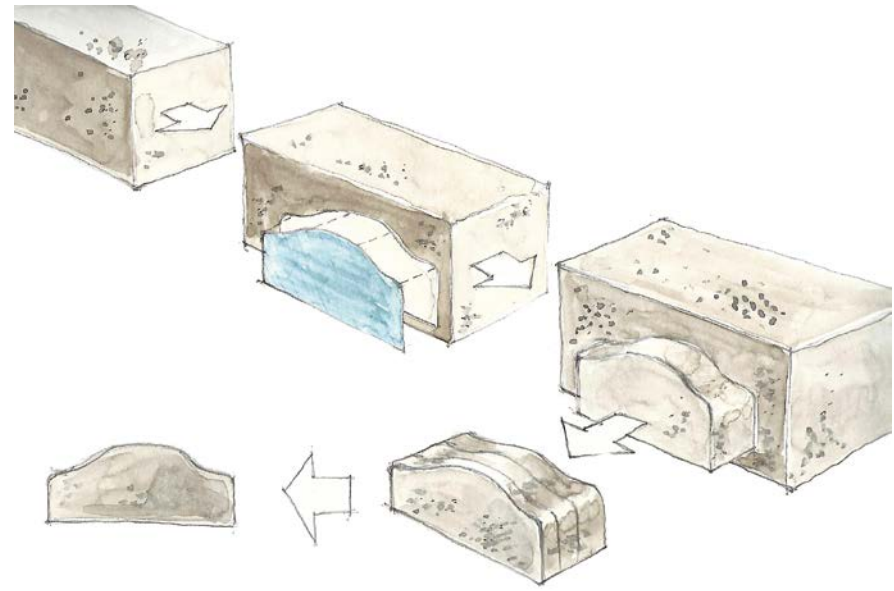

Dal sapiente taglio dei blocchi di gomma nascono tutte le imbottiture. Nelle imbottiture è di fondamentale importanza saper usare le varie densità di gomma in quanto ogni parte del letto risponde ad esigenze estetico-funzionali diverse. Oltre ad una sapiente scelta delle gomme Bolzan letti riduce al minimo gli scarti riutilizzandoli attraverso processi di rigenerazione degli scarti stessi, diminuendo così l'impatto industriale sul pianeta, una filosofia che Bolzan letti segue in tutte le parti del suo processo industriale.

From the clever cutting of the foam blocks all the paddings are formed. In the paddings it is essential to know how to use different foam densities as each part of the bed responds to different aesthetic-functional requirements. In addition to a wise choice of the foams, Bolzan Letti reduces the waste by reusing them through regeneration processes, thus reducing the industrial impact on the planet, a philosophy that Bolzan Letti pursues in every step of its industrial process.



QUALITY SYSTEM

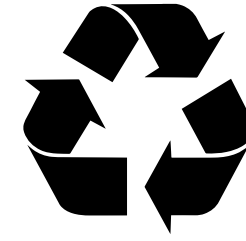

RICICLABILE / RECYCLABLE

Le parti sagomate che utilizziamo all'interno della produzione vengono realizzate internamente, mentre le rimanenze vengono riconvertite in lastre di espanso agglomerato ad alta densità (120/200 D.), che viene riutilizzato all'interno della nostra produzione. In questa maniera ricicliamo completamente tutta la gomma. The molded parts we use during the production are made internally, while the scraps are converted into high-density agglomerated foam slabs (120/200 D), which are reused in our production. In this way we completely recycle the rubber.



RESISTENTE AL FUOCO / FIRE RESISTANT

Tutti gli imbottiti vengono foderati con dacron accoppiato a velfodera resistente alla luce ed ignifuga, secondo le normative BRITISH STANDARD. All the padded parts are lined with dacron coupled with flame retardant and light resistant velfodera, according to BRITISH STANDARD laws.



RIVALUTABILE / REVALUABLE

Alla fine del nostro processo produttivo non buttiamo via niente. Questo permette un'ottimizzazione del processo lavorativo in un'ottica di rispetto ambientale e delle risorse a disposizione. At the end of our production process we do not throw away anything. This allows an optimization of the work process in an environmentally friendly and resourceful manner.



QUALITY SYSTEM

IL TESSUTO

THE FABRIC



Un tessuto è un manufatto a superficie piana, sottile e flessibile realizzato tramite un intreccio di fili perpendicolari tra di loro; l'operazione necessaria per realizzarlo si chiama tessitura.

È costituito da due elementi: l'ordito o catena, ossia l'insieme di fili tesi sul telaio, e la trama, unico filo che percorre da una parte all'altra l'ordito. I tessuti possono essere formati da fibre vegetali come il lino o il cotone, animali come la lana e la seta o fibre artificiali che con la loro economicità e facilità di produzione hanno invaso il mercato riducendo l'utilizzo delle fibre naturali.

Fibre animali:

Lana, viene prodotta con il pelo di animali può essere pura o combinata con una miscelatura di lane di origine diversa.

Sul mercato troviamo tessuti in lana di: pecora (pura lana vergine, merinos, lambswool), alpaca, vigogna, cammello, cashmere e mohair (razze di capre), angora (una razza di conigli).

Seta è prodotta dal baco da seta (bombyx mori), insetto che produce un bozzolo filamentoso. Per avere un'ottima seta il baco deve crescere su alberi di gelso, infatti la seta indiana è più ruvida perché il baco cresce e si nutre su un'altra pianta. Quando è ancora vivo viene bollito per ricavarne il massimo dal filamento.

Fibre vegetali

Ricavate dalle fibre presenti nei fusti o intorno ai semi di alcune piante: lino (fibra del fusto della pianta *Linum usitatissimum*), cotone, canapa, juta, rafia, ramie, kapok, kenaf, bambù, zucchero di canna, sisal...

A fabric is a flat, thin and flexible surface made with a woven mesh of perpendicular threads; the operation needed to make it is called weaving.

It consists of two elements: the warp, that is, the set of threaded threads on the loom, and the weft, the only thread that runs the warp from one side to the other. The fabrics can be made from vegetable fibers such as linen or cotton, animal fibers such as wool and silk or artificial fibers that, with their cost-effectiveness and ease of production, invaded the market by reducing the use of natural fibers.

Animal fibers:

Wool, is produced with animal hair, it can be pure or combined with a mix of wool of different origin.

On the market we find fabrics made of wool from: sheep (pure virgin wool, merinos, lambswool), alpaca, vicuna, camel, cashmere and mohair (goat breeds), angora (a breed of rabbits).

Silk is produced by silkworm (bombyx mori), an insect that produces a filamentous cocoon. To have a good silk, the worm has to grow on mulberry trees, Indian silk is more rough because the bug grows and eats on another plant. When it is still alive it is boiled to get the most from the filament.

Vegetable Fibres

Made from fibers in the barrels or around the seeds of some plants: linseed (*Linum usitatissimum* plant fiber), cotton, hemp, jute, raffia, ramie, kapok, kenaf, bamboo, cane sugar, sisal ...

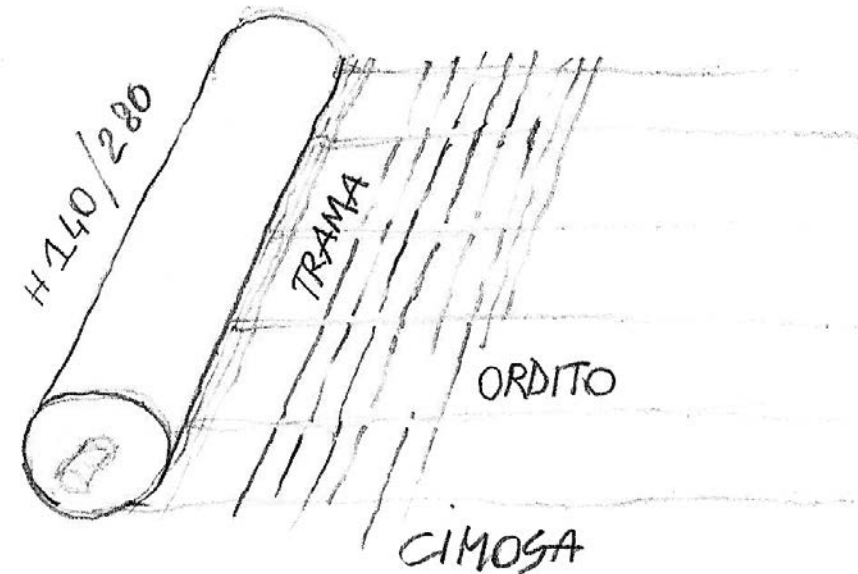

QUALITY SYSTEM

LA PELLE

THE LEATHER

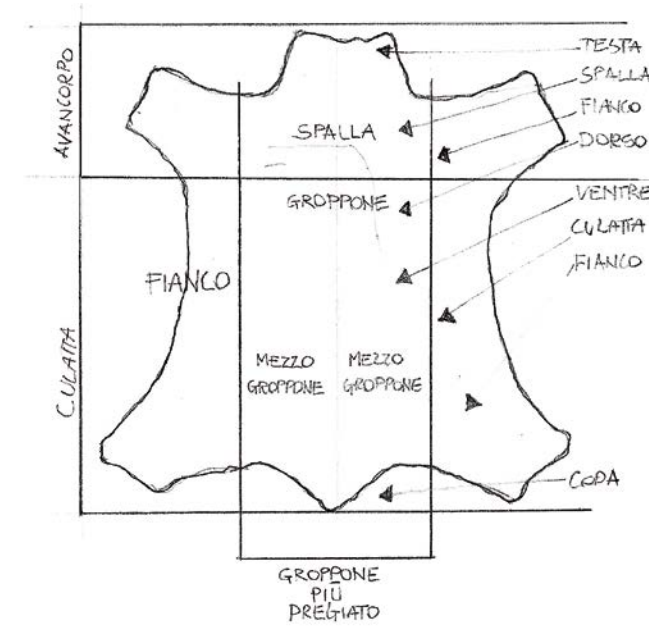

La schiena Groppone (A) è la parte più pregiata della pelle e rappresenta circa il 50% dell'intera superficie della pelle (dorso). In confronto alla pancia questa zona solitamente presenta meno lesioni. Le fibre hanno una struttura densa e uniforme. Il groppone viene utilizzato per le parti frontali delle testiere e le parti frontali dei giroletti. Le spalle presentano una struttura più densa delle fibre. Esse rappresentano circa il 25% dell'intera superficie della pelle. Le spalle vengono utilizzate per i fianchi laterali delle testiere. I fianchi e la pancia sono più sottili del groppone. Particolarmente morbida è la cosiddetta pancetta detta anche trippa. I fianchi rappresentano ciascuno il 12.5 % dell'intera superficie della pelle. Questa pelle viene utilizzata per le parti inferiori o nascoste delle testiere o dei giroletti.

La pelle utilizzata è stata lavorata artigianalmente ed è il risultato di una attenta selezione. Pertanto le sue imperfezioni, le eventuali irregolarità o la non uniformità del materiale, del colore sono da considerarsi caratteristiche di pregio ed autenticità e non difetti. Così come il naturale utilizzo nel corso del tempo potrebbe alterarne il colore e l'aspetto. Le pelli e complessivamente i prodotti, sono trattati con fissaggi e lavorazioni manuali che mettono in evidenza le sfumature del colore rendendo questi prodotti esclusivi e unici. Per mantenere inalterate tali caratteristiche le consigliamo di conservare con cura questo prodotto e di evitare l'utilizzo di prodotti auto-lucidanti.

The back (A) is the most precious part of the skin and represents about 50% of the entire surface of the skin. Compared to the belly this area usually has fewer injuries. The fibers have a dense, uniform texture. The back is used for the front parts of the headboards and the front parts of the bedstructures. Shoulders have a thicker fiber structure. They represent about 25% of the entire surface of the skin. The shoulders are used for side panels of the headboards. The hips and belly are thinner than the back. Particularly soft is the belly.

Hips represent each 12.5% of the entire surface of the skin. This skin is used for the lower or hidden parts of headboards or bed frames.

The leather we use, has been handcrafted and is the result of careful selection. Therefore its imperfections, any irregularities or non-uniformity of the material, of color are to be regarded as qualities of preciousness and authenticity and not flaws. Just as the normal use over time could alter color and appearance. Skins and all products are handled with manual work that highlight the nuances of color making these products exclusive and unique. To keep these features unchanged, we recommend that you carefully keep this product and avoid using self-polishing products.

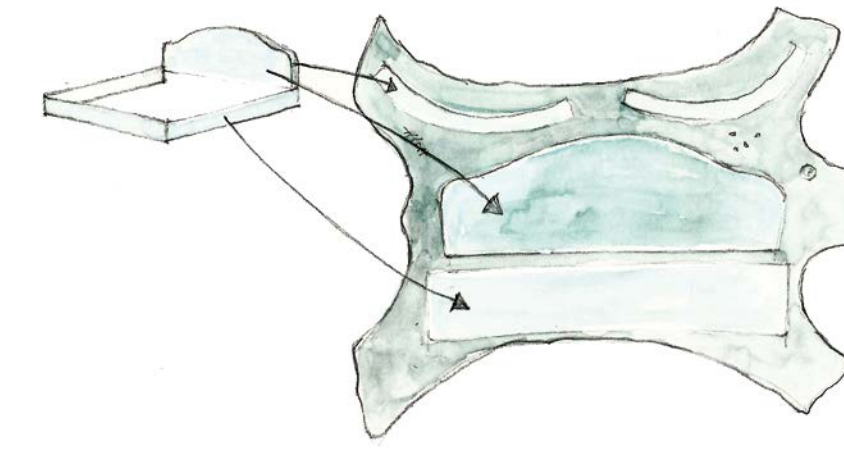

QUALITY SYSTEM

LE CUCITURE THE SEAMS

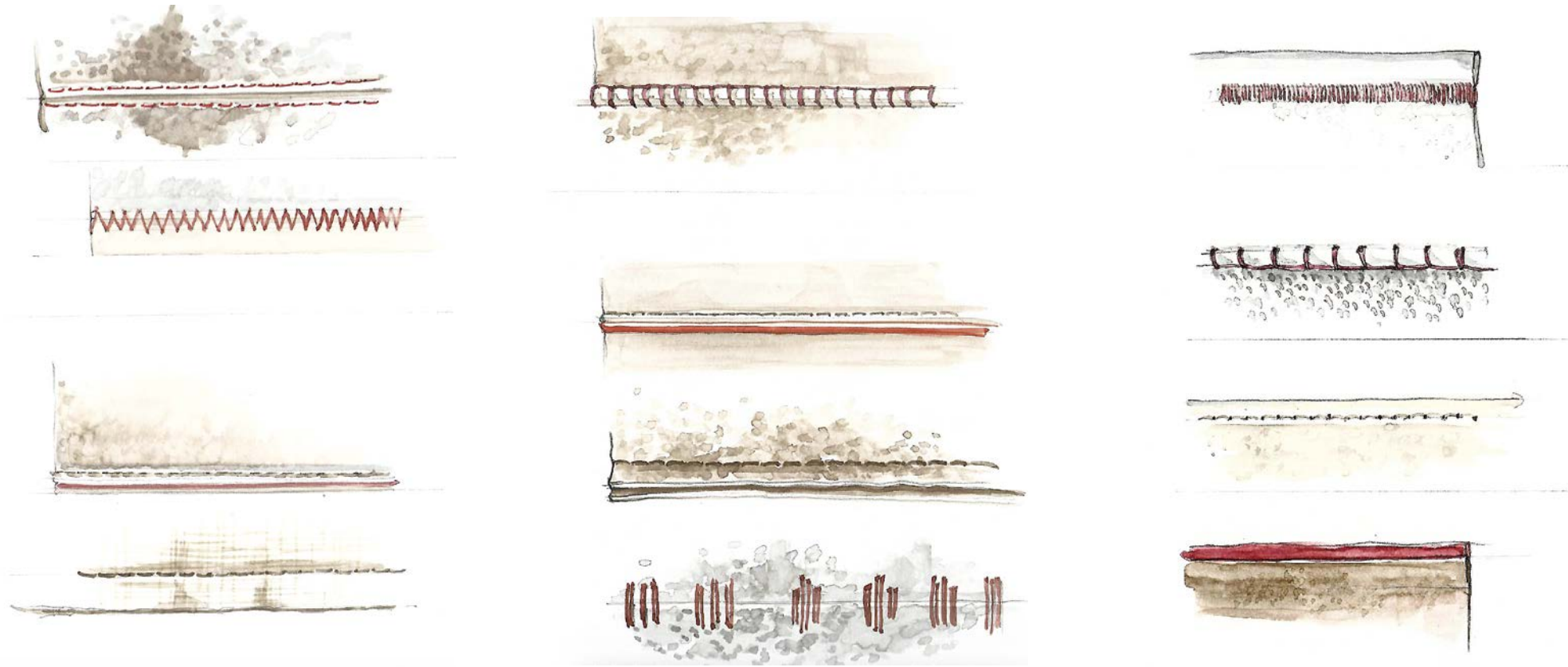

Il dettaglio è quello che definisce la qualità del prodotto. La semplice cucitura quindi assume un'importanza di primissimo livello perchè proprio dalla sua precisione e soprattutto dell'effetto estetico che riesce a dare, fa vivere un prodotto in modo diverso e sicuramente più personale.

The detail is what defines the quality of the product. The simple stitching therefore takes on a very high level of importance because from its precision and above all the aesthetic effect it can give, makes a product different and surely more personal.

QUALITY SYSTEM

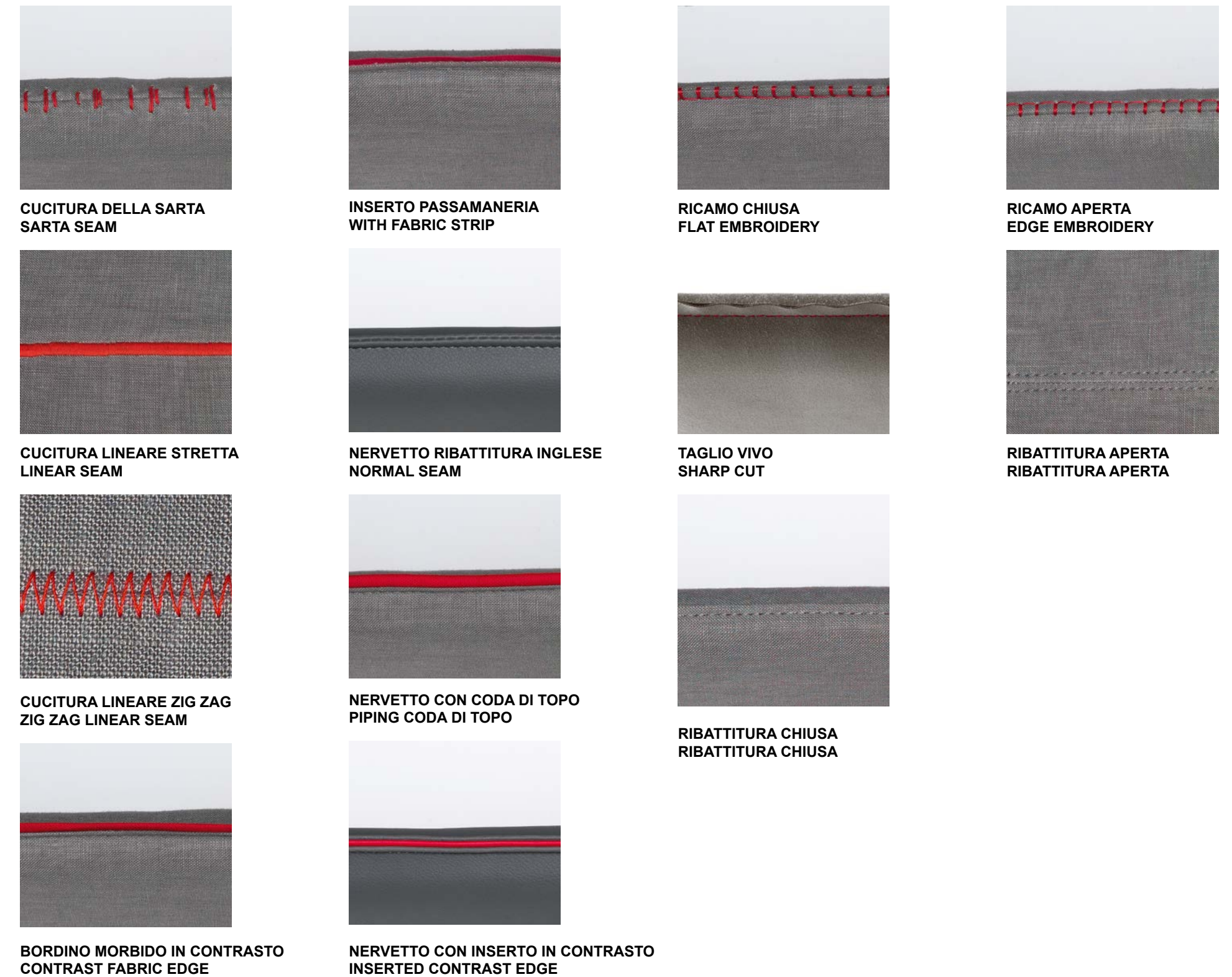

CUCITURA DELLA SARTA
SARTA SEAM

INSERTO PASSAMANERIA
WITH FABRIC STRIP

RICAMO CHIUSA
FLAT EMBROIDERY

RICAMO APERTA
EDGE EMBROIDERY

CUCITURA LINEARE STRETTA
LINEAR SEAM

NERVETTO RIBATTITURA INGLESE
NORMAL SEAM

TAGLIO VIVO
SHARP CUT

RIBATTITURA APERTA
RIBATTITURA APERTA

CUCITURA LINEARE ZIG ZAG
ZIG ZAG LINEAR SEAM

NERVETTO CON CODA DI TOPO
PIPING CODA DI TOPO

RIBATTITURA CHIUSA
RIBATTITURA CHIUSA

BORDINO MORBIDO IN CONTRASTO
CONTRAST FABRIC EDGE

NERVETTO CON INSERTO IN CONTRASTO
INSERTED CONTRAST EDGE

QUALITY SYSTEM

I GIROLETTI THE BEDFRAMES



GIROLETTO SOTTILE H9, LIGHT, SMILE



GIROLETTO H. 29 ABETE



GIROLETTO H. 29 ALLUMINIO



GIROLETTO H. 29 BOX SPRING



Tutti i giroletti Bolzan sono progettati per consentire un'ottimale pulizia.

All Bolzan Letti bedframes are designed to allow an excellent cleaning.



La comoda maniglia in cuoio permette una facile rimozione del fondo del box per una ottimale pulizia.

The comfortable leather handle allows easy removal of the bottom of the storage for an excellent cleaning.

QUALITY SYSTEM

LE TESTIERE THE HEADBOARDS

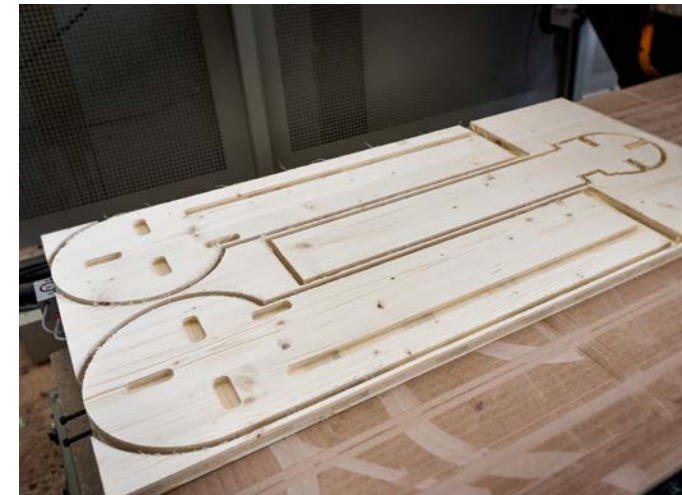

L'artigianalità e la passione per il proprio lavoro è da sempre uno dei punti di forza di Bolzan letti.



The craftsmanship and passion for its work has always been one of Bolzan Letti's strengths

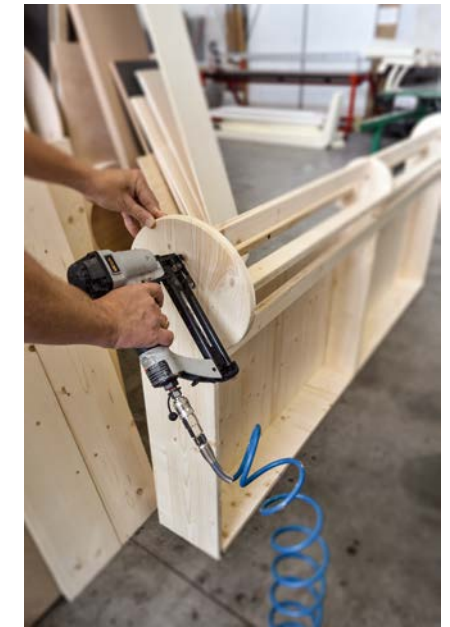

Artigianalità unita a materiali di prima scelta, la sapiente lavorazione manuale a partire dalla sagomatura del legno per passare all'imbottitura studiata per garantire il massimo comfort possibile, passando attraverso ad un rivestimento creato da un reparto sartoria ad altissima specializzazione permette a Bolzan letti di produrre oggetti di assoluto design .

Craftsmanship with high-quality materials, clever manual work from the shaping of the wood to the padding designed to guarantee the maximum comfort, passing through a cover created by a very special tailoring department allows Bolzan to produce absolute design objects.

QUALITY SYSTEM

I MECCANISMI THE MECHANISMS



**MECCANISMO HANDS-FREE /
HANDS-FREE MECHANISM**

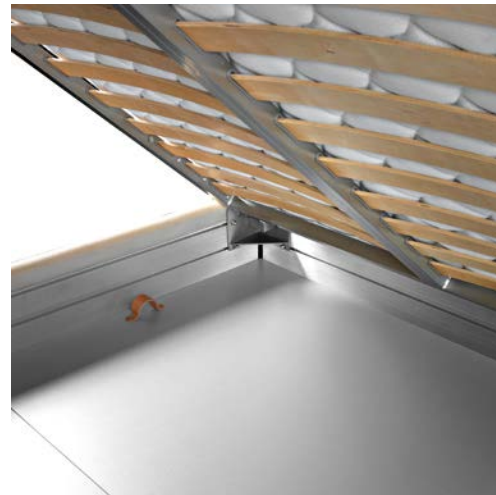

**MECCANISMO BOX /
BOX MECHANISM**

Tutti i meccanismi utilizzati da Bolzan letti sono personalizzati per permettere un migliore utilizzo del meccanismo stesso. Nuovissimo il meccanismo HANDS FREE permette l'apertura del box senza l'uso delle mani e grazie al box completamente in alluminio è privo di pistoncini a vista mantenendo così un design di altissimo livello. Anche il meccanismo EASY UP è stato modificato in maniera che la rete una volta sollevata non sporga dalla pediera del letto, ottimizzando così lo spazio all'interno della stanza.

All the mechanisms used by Bolzan beds are customized to allow better use of the mechanism itself. The new HANDS FREE mechanism allows the opening of the box without the use of hands and thanks to the fully aluminum box it has no visible piston, thus maintaining a very high level of design. The EASY UP mechanism has also been modified so that the raised wooden slat does not stick out from the lower bedframe, thus optimizing the space inside the room.



**MECCANISMO EASY-UP /
EASY-UP MECHANISM**



QUALITY SYSTEM

LE RETI THE WOODEN SLATS



**RETE PER MECCANISMO BOX /
BOX EASY UP /
SLATTED BASE FOR BOX / EASY UP
BOX MECHANISM**



**RETE PER MECCANISMO
HANDS FREE
SLATTED BASE FOR HANDS FREE ME-
CHANISM**



**RETE A PIANALE FISSA E PER
BOX /
FIXED OR BOX WOODEN BASE**

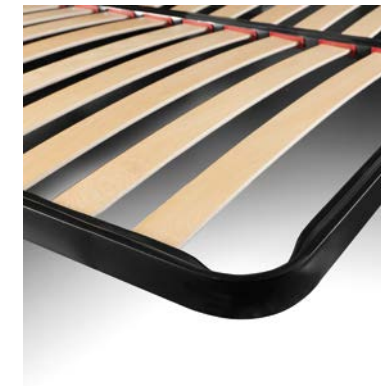

**RETE FISSA A DOGHE /
FIXED SLATTED BASE**



**RETE DINAMIC FISSA A DOGHE
CON BALESTRINI /
DINAMIC FIXED SLATTED BASE WITH
HARDNESS REGULATORS**



**RETE IN LEGNO FISSA A
DOGHE /
WOODEN SLATTED BASE**



**SOMMIER CONTRACT /
SOMMIER CONTRACT**

corolle





corolle h 9

Il colore dei tessuti, l'atmosfera creata da una scelta cromatica accurata, la sinuosità della linea compositiva: vi presentiamo Corolle.

The colour of fabrics, the atmosphere created by a carefully selected colour scheme, the sinuous lines of the composition: this is Corolle.



corolle box

Estetica e funzionalità convivono in sintonia: ai giochi cromatici si affianca la praticità del box contenitore.

Aesthetic and functionality combined in one bed: the chromatic effects and the practical storage box.







corolle complementi

I giochi creati dalle diversità delle forme geometriche e dei colori dei complementi "corolle" vivacizzano l'ambiente senza disturbarne l'armonia.

The design created by the different geometrical shapes and colors of Corolle complements make the environment more lively without disturbing its harmony.

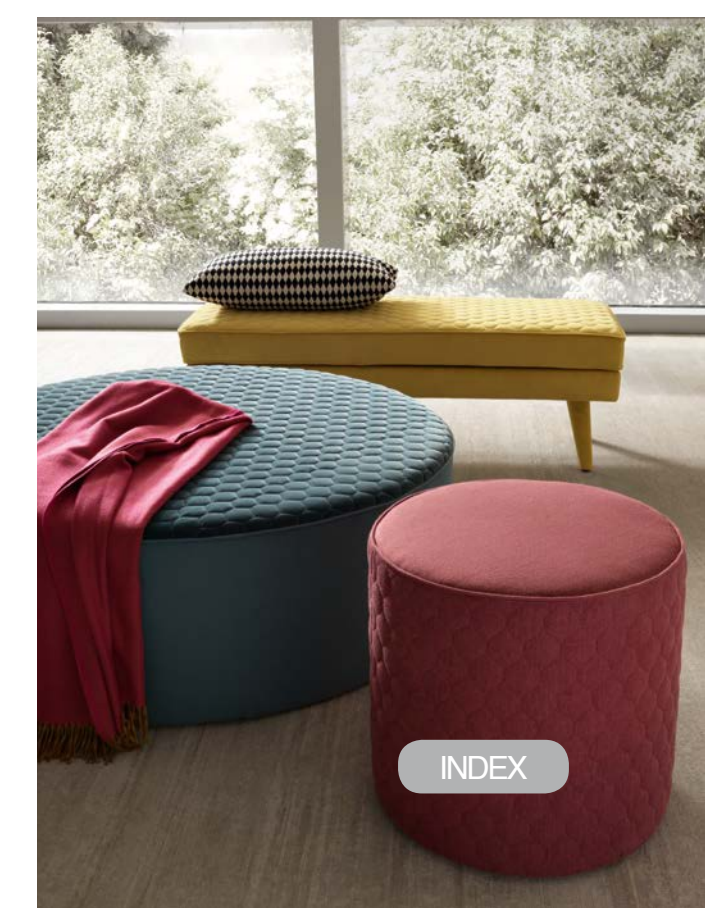



technical details

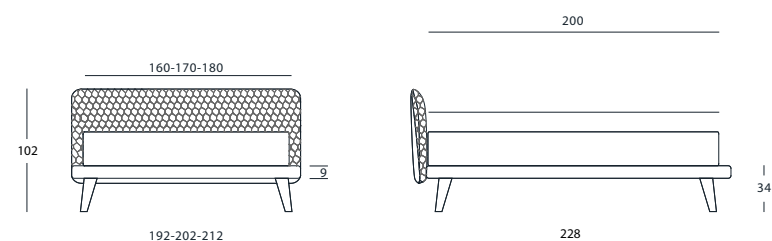

VERSIONE H 9

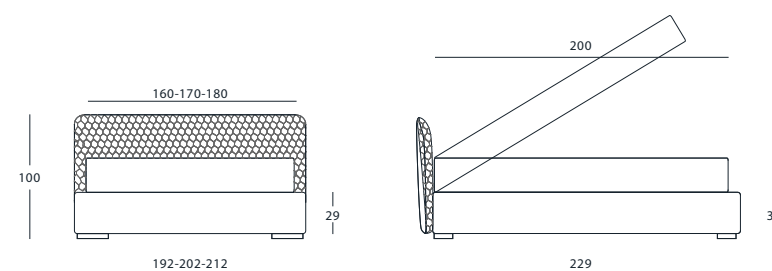

VERSIONE BOX

Letto completamente sfoderabile, disponibile con basamento sottile o sagomato h.29 telaio in legno o in alluminio con o senza box e c/box easy up, hands free o box spring. (vedi pag. 014).

Realizzabile unicamente in tessuto.

Basamento sottile disponibile con piede vasetto, vasetto inclinato, inox, plaza, bridge, slitt, linea, gold e dorian. Piedi in legno disponibili anche laccati scala ral o rivestiti in tessuto o pelle (vedi pag. 348)

Basamento sagomato h.29 disponibile con piede vasetto, cipolla, fiorence, tubetto, inox o system anche laccati scala ral (vedi pag. 349)

The bed cover is completely removable, available with thin or h.29 cm rounded bedbase, bedframe of solid wood or aluminum with or without storage box and with box easy up, hands free or box springs(see page 014)
The bed cover is available only in fabric.

Thin bedbase available with the following feet: vasetto, vasetto inclinati, inox, plaza, bridge, slitt, linea, gold and dorian. Wood feet available also lacquered in a color of the ral system or covered in fabric or leather (see page 348).

Rounded bedbase h.29 available with the following feet: vasetto, cipolla, fiorence, tubetto, inox or system also lacquered in a color of the ral system (see page 349)

Cuciture, seams:



nervetto con coda di topo
piping coda di topo

Predisposto per materassi: l 160-170-180 x p 200

For mattresses: w 63" – 67" – 70 3/4" x d 78 3/4"

Queen size: predisposto per materassi l 153 x p 203 for mattresses w 60"x d 80"

King size: predisposto per materassi l 193-198 x p 203 for mattresses w 76"x d 80"



kate





kate h 9

Il glamour del bianco, la naturaità del tessuto, la lavorazione artigianale delle cuciture a vista della testiera sono i tratti distintivi per riconoscere Kate.

The glamour of white, the nature of the fabric and the visible crafted stitching on the headboard are the distinguishing features to recognize Kate.



oyster comò 2 cassetti

L'eleganza e il glamour si uniscono in un perfetto equilibrio di materiali creando il comò adatto ad ogni camera da letto.

Elegance and glamour are united in a perfect balance of materials creating the chest of drawers suitable for every bedroom.



kate h9

Soluzioni funzionali evolute e design rigoroso per la zona notte contemporanea. Kate propone un sistema letto ispirato alla massima semplicità delle forme con un pizzico di originalità nelle cuciture e nella testata imbottita.

Advanced solutions and rigorous design for the contemporary sleeping area. Kate is a bed with absolutely simple lines highlighted by its brand-new seams and its padded headboard.





kate box

edith pouf

Estremamente elegante con l'aggiunta del piano in marmo, senza però dimenticare la funzionalità il pouf Edith può essere dotato di dispositivo usb per la ricarica degli smarphone.

Extremely elegant with the new marble top, Edith pouf does not forget functionality and can be equipped with usb recharge unit for smart-phones.



kate



technical details

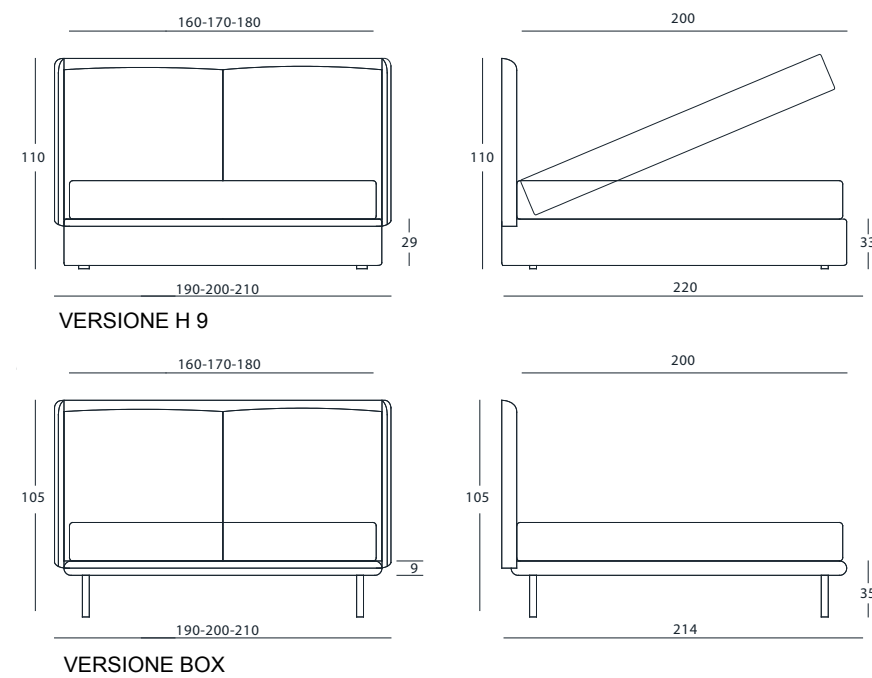

Letto completamente sfoderabile in tessuto e testiera non sfoderabile in pelle ed ecopelle, disponibile con basamento sottile o sagomato h.29 con telaio in legno o in alluminio con o senza box, hands free o box spring. (vedi pag. 014).

Basamento sottile disponibile con piede vasetto, vasetto inclinato, inox, plaza, bridge, slitt, linea, gold e dorian. Piedi in legno disponibili anche laccati scala ral o rivestiti in tessuto o pelle (vedi pag 348).

Basamento sagomato h.29 disponibile con piede vasetto, cipolla, florence, tubetto, inox o system anche laccati scala ral (vedi pag 349)

The bed cover made of fabric is completely removable, the headboard cover made of leather or eco-leather is non removable, available with thin or h.29 cm rounded bedbase, bedframe of solid wood or aluminum with or without storage box, hands free or box spring (see page 014).

Thin bedbase available with the following feet: vasetto, vasetto inclinati, inox, plaza, bridge, slitt, linea, gold and dorian. Wood feet available also lacquered in a color of the ral system or covered in fabric or leather (see page 348).

Rounded bedbase h.29 available with the following feet: vasetto, cipolla, florence, tubetto, inox or system also lacquered in a color of the ral system (see page 349)

cuciture, seams:



nervetto con coda di topo
piping coda di topo

Predisposto per materassi: l 160-170-180 x p 200

For mattresses: w 63" – 67" – 70 3/4" x d 78 3/4"

Queen size: predisposto per materassi l 153 x p 203 for mattresses w 60" x d 80"

King size: predisposto per materassi l 193-198 x p 203 for mattresses w 76" x d 80"



jill



jill

Jill è caratterizzato da volumi soffici e generosi, con una testiera morbida che rende il letto un'alcova confortevole all'interno dello spazio domestico

Jill is characterized by tender and generous volumes, with a soft headboard that makes the bed a comfortable alcove inside the home space





jill poltroncina

Grazie alle proporzioni armoniose e alle dimensioni contenute, è facile l'inserimento della poltrona Jill nell'arredamento di casa, dal living allo studio fino alla camera da letto.

Jill armchair with its delicate and fine outline can easily fit in all the rooms of the house, from the living room till the bedroom.



jill box





jill box

Personalizzabile nei colori, Jill arreda la zona notte con uno spirito allegro, spensierato e al passo con le tendenze dell'arredo moderno.

Jill is highly personalisable and with its lively colours furnishes bedrooms with a pleasant and carefree spirit in line with trends for modern decor.





circus pouf

La forma circolare, dinamica e gioiosa, e le svariate finiture lo rendono versatile e adattabile. In modalità seriale arreda e completa ogni ambiente. Un prodotto semplice ma compiuto.

The round shape, dynamic and joyful, and the various finishes makes it easy-fitting and versatile. Place more than one in a room and you will furnish it completely. A simple but essential accessory.



jill tavolino

Sapientemente abbinato al tavolino Jill dalla forma semplice e rigorosa. Si presenta con un preciso carattere basato su un mix di ricerca, innovazione di materiali e tecnologia produttiva.

Jill table complements perfectly the bed and highlights the use of new materials combined with careful manufacturing.



Letto completamente sfoderabile realizzabile unicamente in tessuto, disponibile con basamento jill o sagomato h.29 con telaio in legno o in alluminio con o senza box e c/box easy up, hands free o box spring. (vedi pag. 014).

Basamento sottile disponibile con piede vasetto, vasetto inclinato, inox, plaza, bridge, slitt, linea, gold e dorian. Piedi in legno disponibili anche laccati scala ral o rivestiti in tessuto o pelle (vedi pag. 348).

Basamento sagomato h.29 disponibile con piede vasetto, cipolla, florence, tubetto, inox o system anche laccati scala ral (vedi pag. 349)

The bed cover is completely removable, available only in fabric, available with jill or h.29 cm rounded bedbase, bedframe of solid wood or aluminum with or without storage box and with box easy up, hands free or box spring (see page 014).

Thin bedbase available with the following feet: vasetto, vasetto inclinati, inox, plaza, bridge, slitt, linea, gold and dorian. Wood feet available also lacquered in a color of the ral system or covered in fabric or leather (see page 348).

Rounded bedbase h.29 available with the following feet: vasetto, cipolla, florence, tubetto, inox or system also lacquered in a color of the ral system (see page 349)

Predisposto per materassi: l 160-170-180 x p 200

For mattresses: w 63" – 67" – 70 ¾" x d 78 ¾"

Queen size: predisposto per materassi l 153 x p 203 for mattresses w 60"x d 80"

King size: predisposto per materassi l 193-198 x p 203 for mattresses w 76"x d 80"

technical details

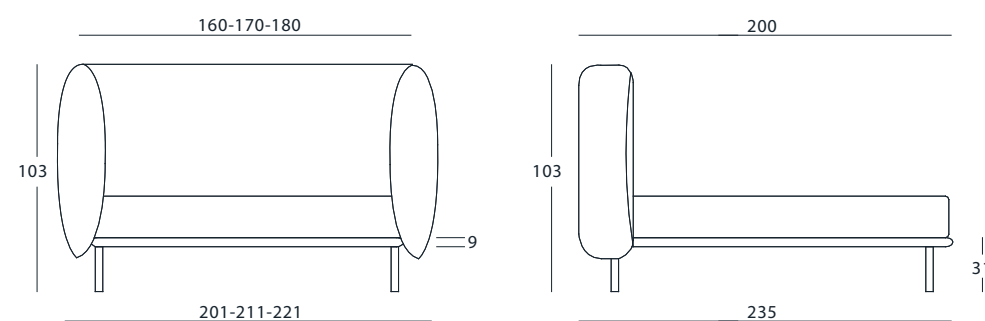

VERSIONE H 9

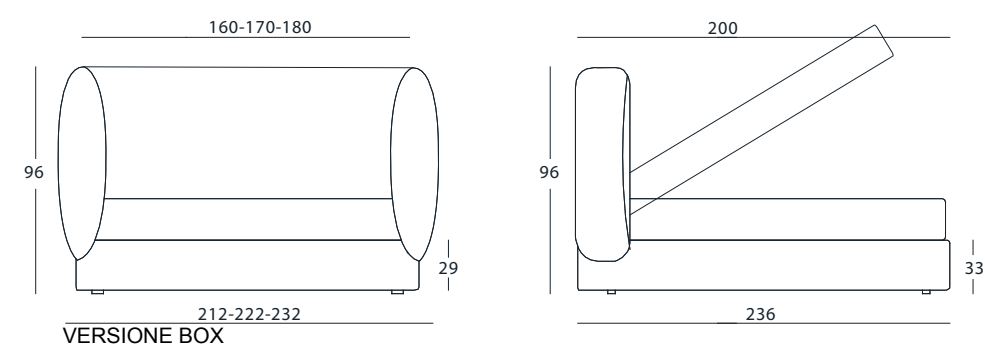

VERSIONE BOX



jack





jack



La luminosità dell'ecopelle rende Jack la scelta d'arredo ideale per coloro che non si accontentano di un semplice letto ma cercano un elemento d'arredo unico.

Bright eco-leather makes Jack a furnishing solution for those who are not happy with a simple bed but are looking for a unique furnishing element.

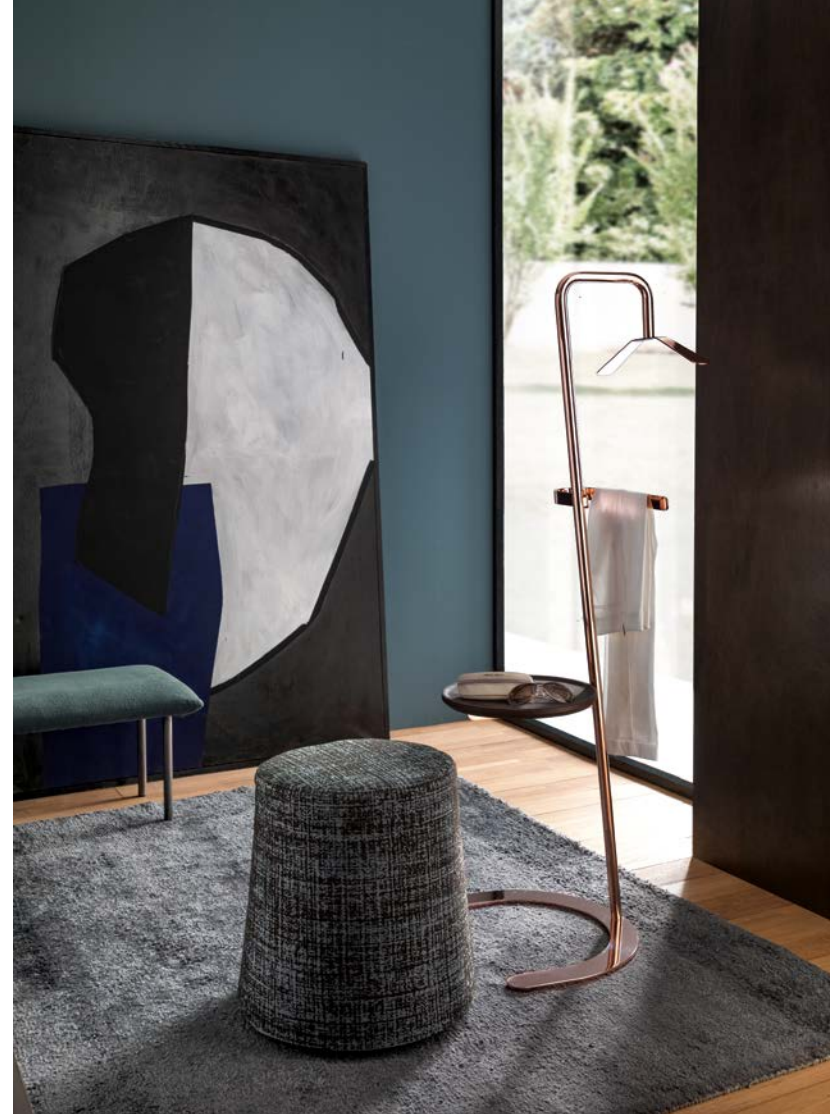

zoe servomuto

Zoe servomuto è l'attaccapanni moderno adatto a tutti coloro che amano gli oggetti scomponibili. L'originalità e la funzionalità formano un connubio ideale.

Zoe valet stand is the ideal coat rack for those who love modular objects. Originality and functionality form a perfect bond.

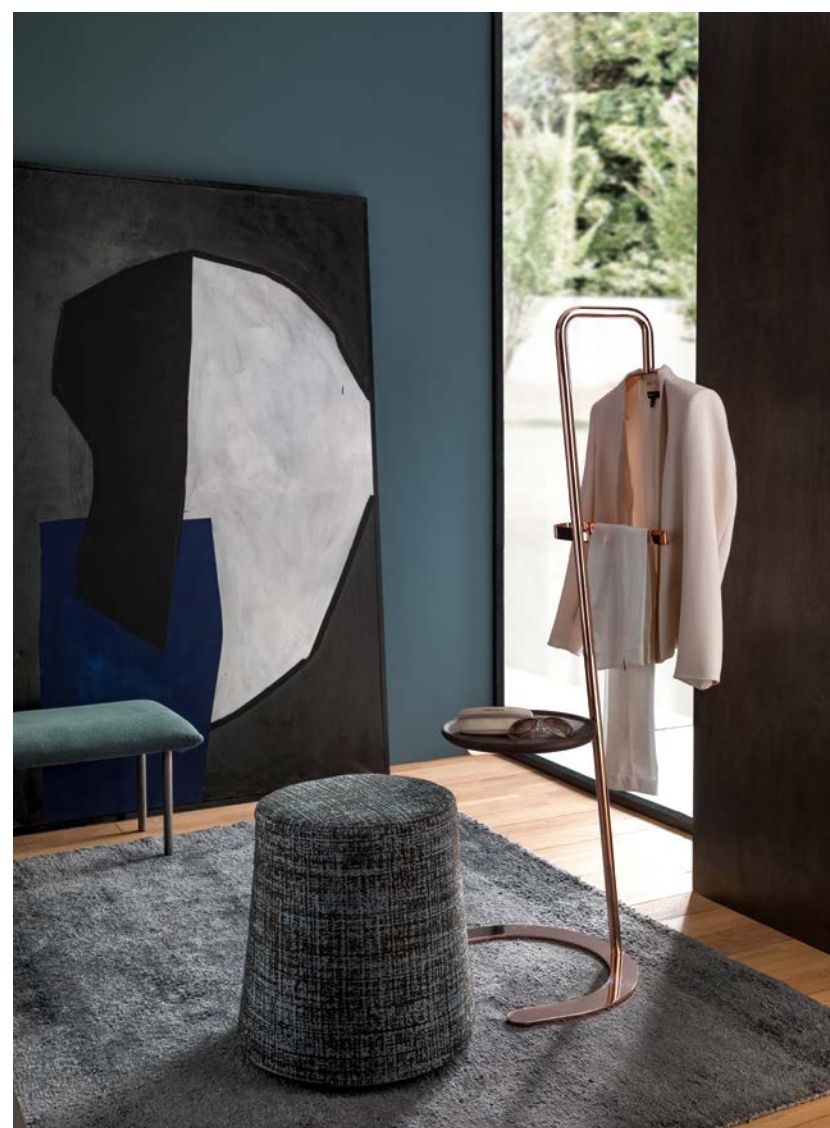

jack



technical details

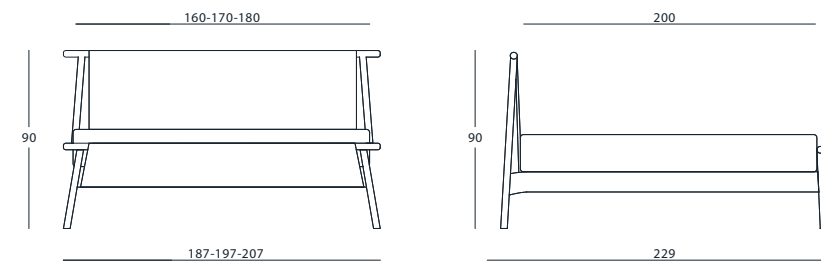

Letto completamente sfoderabile, rivestimento disponibile reversibile e non reversibile.

Disponibile nelle finiture: ral 5008 blu grigio opaco, ral 8019 marrone grigio opaco, ral 7044 grigio seta opaco e ral 3005 rosso vino opaco.

The bed cover is completely removable, reversible or non-reversible cover available

Available in the following finishings: blue grey ral 5008, grey brown 8019, silk grey 7044, wine red 3005 laquered.

Predisposto per materassi: l 160-170-180 x p 200

For mattresses: w 63" – 67" – 70 ¾" x d 78 ¾"



tulip





tulip double

Al centro della zona notte, sia giovane che classica, la linea compositiva di Tulip double è in grado di arredare da sola la camera dei nostri sogni.

In the centre of a contemporary or classic sleeping area, Tulip double alone can furnish the bedroom of our dreams.

tulip





circus capitoné pouf

Circus capitoné arreda la casa di chi non vuole rinunciare alla memoria e desidera che il letto rappresenti una continuità con le forme da sempre tramandate.

Circus capitoné furnishes the house of those who do not want to forget the past, and desire their bed to be a continuity of shapes handed on since ever.

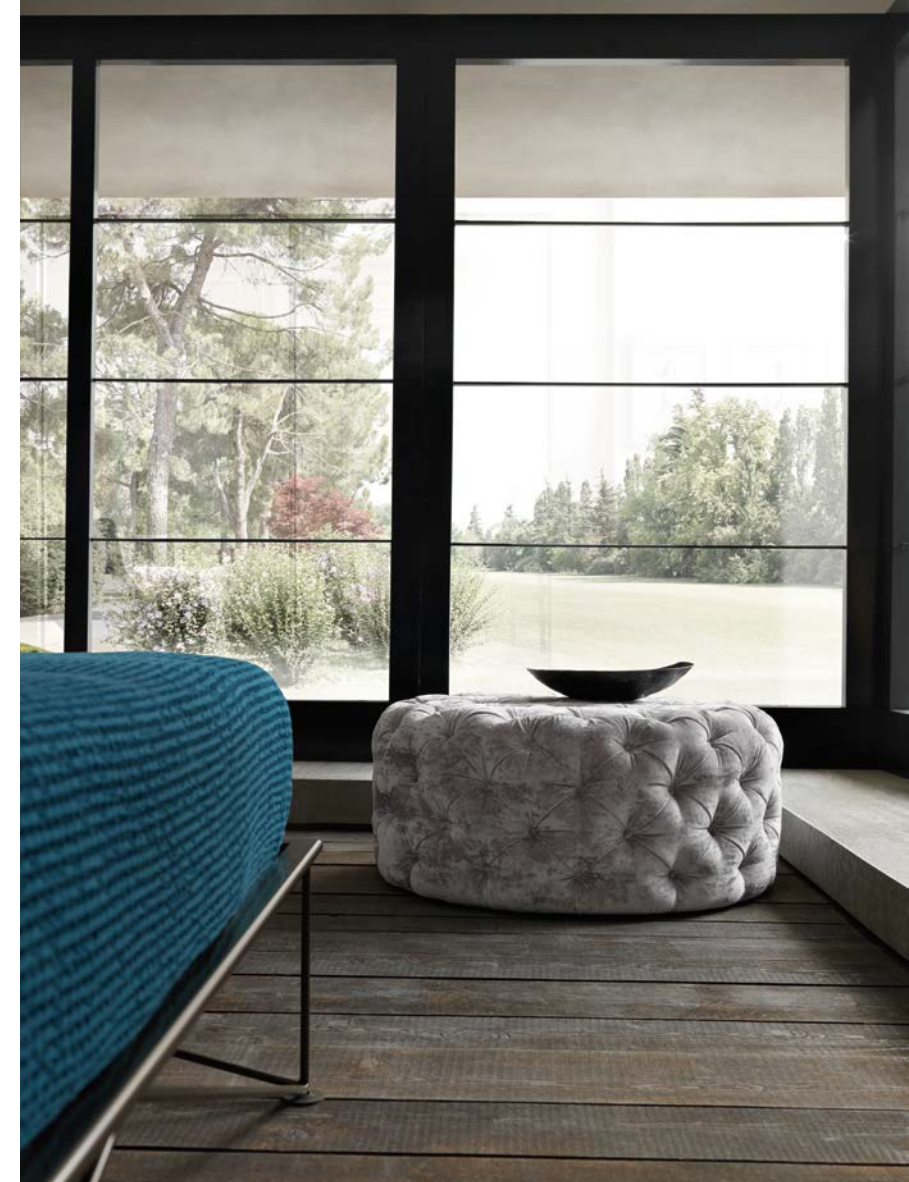





tulip panchetta





tulip young

Tulip young arreda la nuova zona notte con il gusto metropolitano di chi è abituato a vivere la vita dei suoi sogni.

Tulip young furnishes the new sleeping area in the metropolitan style of those who are used to our contemporary lifestyle.



sun pouf

round pouf

Con colori accesi e forme cilindriche Round è una novità giovane e divertente, ma allo stesso tempo pratica e versatile, per dare nuove forme al comfort ed alla convivialità domestica. Una metropoli di edifici in miniatura, colorati, soffici e accoglienti, per arredare il paesaggio domestico e collettivo.

With its bright colours and its cylindrical shape Round pouf is a young and funny article but at the same time practical and versatile, giving new shapes to comfort and cherished moments.

A skyline of miniature buildings, coloured, soft and comfortable that can furnish both private and public panoramas.



tulip pool

La struttura sottile dona a Tulip pool una sensazione di leggerezza che pochi altri possiedono. Un oggetto di design utile per trascorrere il tempo in pieno relax.

Tulip pool is characterised by the thin structure that enhances the unique lightness of this design object: a piece of furniture ideal to spend a relaxing time.



tulip - tulip young - tulip pool



technical details

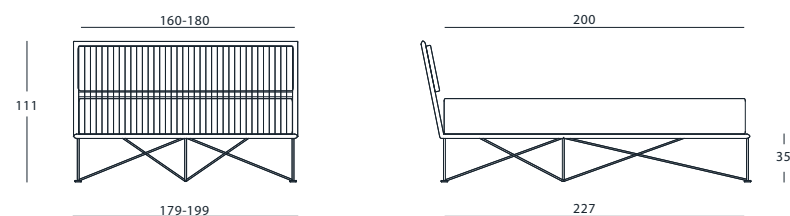

tulip

Testiera non sfoderabile.

Disponibile nelle finiture: laccato bianco puro ral 9010, laccato nero grafite ral 9011, laccato rosso carminio ral 3002 e laccato verde ossido cromo ral 6020.

The headboard cover is non removable.

Available in the following finishings: pure white ral 9010, graphite black ral 9011, carmine red ral 3002 and chrome green 6020 laquered.

Predisposto per materassi: l 160-180 x p 200

For mattresses: w 63" – 70 3/4" x d 78 3/4"

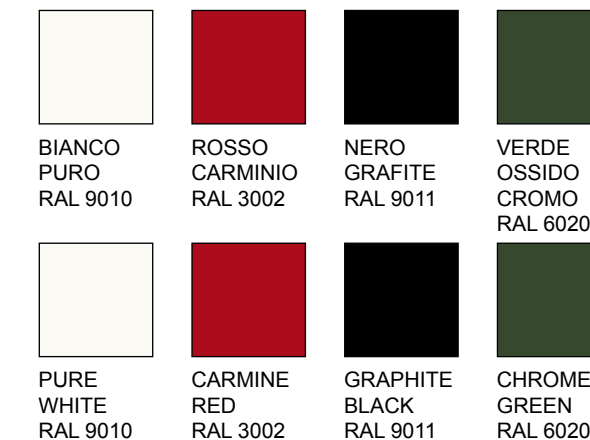

tulip young

Testiera non sfoderabile.

Disponibile nelle finiture: laccato bianco puro ral 9010, laccato nero grafite ral 9011, laccato rosso carminio ral 3002 e laccato verde ossido cromo ral 6020.

The headboard cover is non removable.

Available in the following finishings: pure white ral 9010, graphite black ral 9011, carmine red ral 3002 and chrome green 6020 lacquered.

Predisposto per materassi: l 160-180 x p 200

For mattresses: w 63" – 70 3/4" x d 78 3/4"



tulip pool

Testiera non sfoderabile.

Disponibile nelle finiture: laccato bianco puro ral 9010.

The headboard cover is non removable.

Available in the following finishings: pure white ral 9010.

Predisposto per materassi: l 160-180 x p 200

For mattresses: w 63" – 70 3/4" x d 78 3/4"



tulip double



technical details

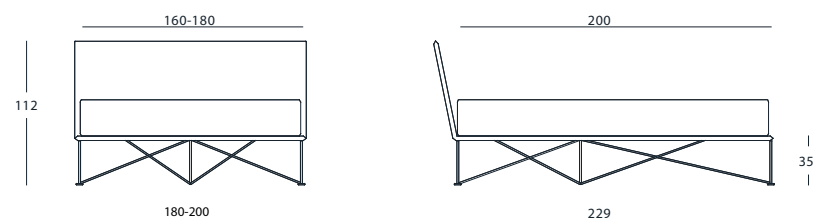

Letto completamente sfoderabile.









Non disponibile in pelle ed ecopelle e con i seguenti tessuti: beat, doublebuk, lalique, lin leger, novabuk e rigatto.

Disponibile nelle finiture: laccato bianco puro ral 9010, laccato nero grafite ral 9011, laccato rosso carminio ral 3002 e laccato verde ossido cromo ral 6020.

The bed cover is completely removable.

Not available in leather, eco-leather or with the followings fabrics: beat, doublebuk, lalique, lin leger, novabuk and rigatto.

Available in the following finishings: pure white ral 9010, graphite black ral 9011, carmine red ral 3002 and chrome green ral 6020 lacquered.

			
BIANCO PURO RAL 9010	ROSSO CARMINIO RAL 3002	NERO GRAFITE RAL 9011	VERDE OSSIDO CROMO RAL 6020
			
PURE WHITE RAL 9010	CARMINE RED RAL 3002	GRAPHITE BLACK RAL 9011	CHROME GREEN RAL 6020

Cuciture, seams:



cucitura della sarta
sarta seam.

Colori vedi cuc.ricamo

Colors see embroidery vedi/see page 364.

Predisposto per materassi: l 160-180 x p 200

For mattresses: w 63" – 70 ¾" x d 78 ¾"



steel



steel light





daytona

comodino 2 cassetti

L' eleganza e la semplicità del comodino a due cassetti "daytona" si addice bene a qualsiasi ambiente lasciando al rivestimento in tessuto il ruolo di protagonista assoluto.

The elegance and simplicity of the "daytona" night table are highlighted by the cover in fabric and make it suitable for every environment.



steel box



oyster oyster

comodino 2 cassetti

comò 3 + 3 cassetti piccoli

Ritorna il fascino di oyster nel comodino a due cassetti e nel comò, sempre elegante in qualsiasi abbinamento proposto. Il piano in marmo in questo caso dona ad "oyster" un glamour del tutto particolare.

The charming Oyster collection is back: a night table with 2 drawers and a chest of drawers that are always elegant in each of the proposed combinations. The marble top gives a particular glamour to this piece of furniture.



steel



technical details

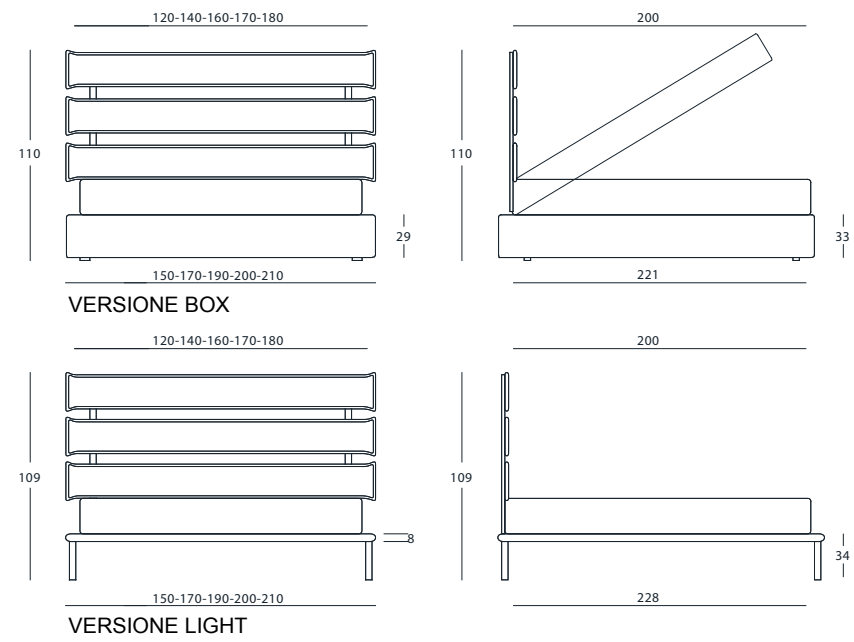

Letto completamente sfoderabile, disponibile con basamento light o sagomato h.29 con telaio in legno o in alluminio con o senza box e c/box easy up, hands free o box spring. (vedi pag. 014).

Realizzabile unicamente in tessuto.

Basamento sottile disponibile con piede vasetto, vasetto inclinato, inox, plaza, bridge, slitt, linea, gold e dorian. Piedi in legno disponibili anche laccati scala ral o rivestiti in tessuto o pelle (vedi pag. 348)

Basamento sagomato h.29 disponibile con piede vasetto, cipolla, florence, tubetto, inox o system anche laccati scala ral (vedi pag. 349)

The bed cover is completely removable, available with light or h.29 cm rounded bedbase, bedframe of solid wood or aluminum with or without storage box and with box easy up, hands free or box spring (see page 014).

The bed cover is available only in fabric.

Thin bedbase available with the following feet: vasetto, vasetto inclinati, inox, plaza, bridge, slitt, linea, gold and dorian. Wood feet available also lacquered in a color of the ral system or covered in fabric or leather (see page 348).

Rounded bedbase h.29 available with the following feet: vasetto, cipolla, florence, tubetto, inox or system also lacquered in a color of the ral system (see page 349)

Predisposto per materassi: l 120-140-160-170-180 x p 200

For mattresses: w 47 2/8" - 55 1/8" - 63" - 67" - 70 3/4" x d 78 3/4"

Full (double) size: predisposto per materassi l 137 x p 190 for mattresses w 54"x d 75"

Queen size: predisposto per materassi l 153 x p 203 for mattresses w 60"x d 80"

King size: predisposto per materassi l 193-198 x p 203 for mattresses w 76"x d 80"



plaza



plaza





plaza

Ampie superfici morbide definite da un grande rigore formale che ben si sposa con i volumi netti dei piedi di supporto.

Wide and soft surfaces defined by linear shapes that matches perfectly with the bold shape of the feet.





atena pouf con dock station

La linea compositiva di Plaza trova il suo compagno ideale nel pouf Atena che pur essendo un semplicissimo trapezio rappresenta un oggetto d'arredo pratico ed elegante, facilmente collocabile in qualsiasi ambiente.

The design of bed Plaza matches perfectly with pouf Atena that, even if it is a simple trapezoid, is a practical and elegant piece of furniture that can be placed in any space.





technical details

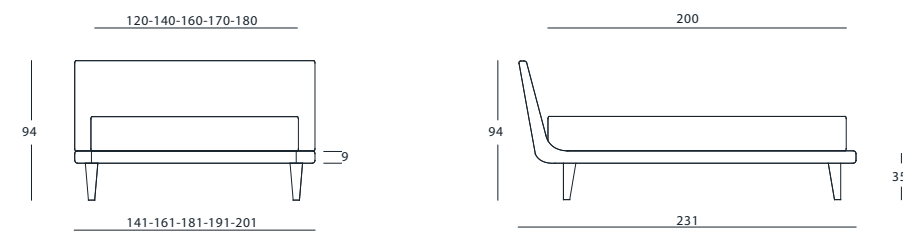

VERSIONE PIEDINI

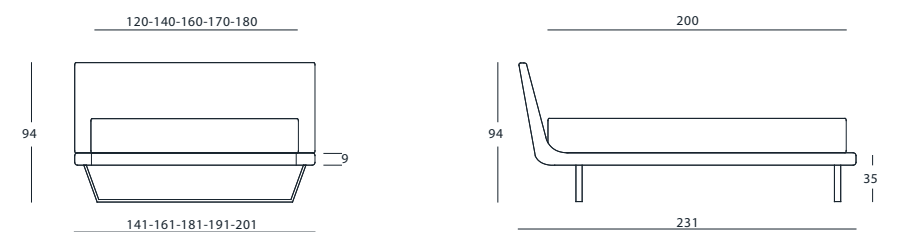

VERSIONE SLITTA

Letto completamente sfoderabile.

Realizzabile unicamente in tessuto e pelle (non ecopelle).

Disponibile con piede vasetto, vasetto inclinato, inox, plaza, bridge, slitt, linea, gold e dorian. Piedi in legno disponibili anche laccati scala ral o rivestiti in tessuto o pelle (vedi pag. 348).

The bed cover is completely removable.

The bed cover is available only in fabric and leather (not in eco-leather).

Available with the following feet: vasetto, vasetto inclinato, inox, plaza, bridge, slitt, linea, gold e dorian. Wood feet available also lacquered in any colour ref. ral system (see page 348)

Predisposto per materassi: l 120-140-160-170-180 x p 200

For mattresses: w 47 2/8" – 55 1/8" – 63" – 67" – 70 3/4" x d 78 3/4"

Full (double) size: predisposto per materassi l 137 x p 190 for mattresses w 54"x d 75"

Queen size: predisposto per materassi l 153 x p 203 for mattresses w 60"x d 80"

King size: predisposto per materassi l 193-198 x p 203 for mattresses w 76"x d 80"

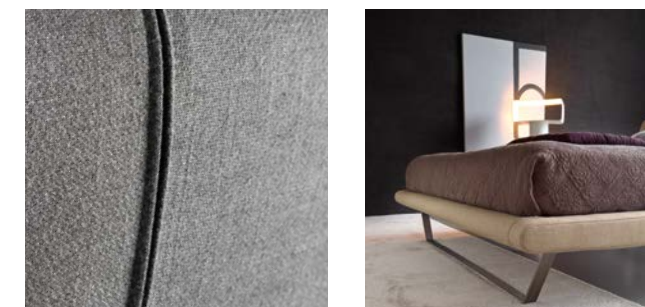

tallis

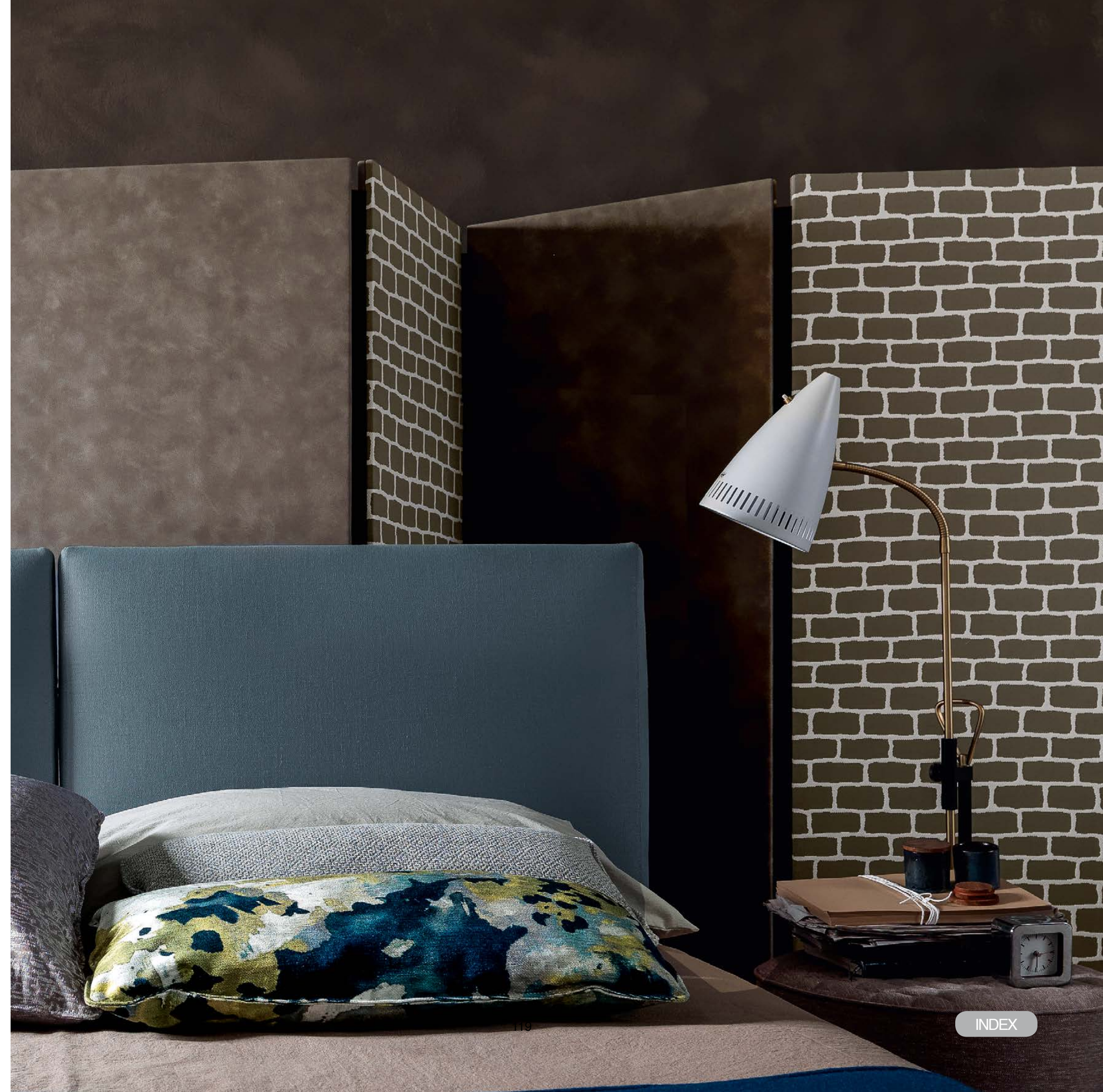

tallis h9







tallis panchetta

La panchetta Tallis fa proprio il concetto "meno è di più" tanto caro all'architetto Ludwig Mies Van der Rohe. Un design minimalista che dà dimostrazione della sua eleganza nei dettagli del tessuto, delle cuciture e dei piedini di appoggio.

The Tallis bench honours the words "less is more" of Ludwig Mies van der Rohe. A minimalistic design highlighted by the elegance of the fabric, of its seams and feet



oyster comò 3 + 3 cassetti piccoli



tallis box

Un letto pensato per ogni camera. Le sue linee pulite e le proporzioni discrete consentono al letto Tallis di adattarsi perfettamente a qualsiasi ambiente.

A bed model that can fit in any bedroom. Its simple lines and the subtle volumes allow Tallis to match perfectly any ambience.



espana panchetta

slim comodino

Le linee arrotondate della testiera si riprendono nei bordi smussati del tavolino Slim che sospende il letto, su un piano di luce che illumina l'intero ambiente domestico. La libertà di scelta dei colori e delle finiture inoltre rappresenta il completamento ideale alla varietà estetica della collezione letti Bolzan.

The rounded lines of the headboard return in the softened corners of Slim bedside table, that suspends the bed over a light surface that brightens up the entire bedroom. The wide choice of colours and finishes gives you the possibility to personalise Bolzan Letti bed collection.





technical details

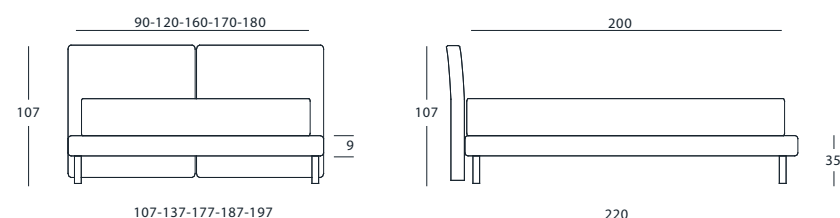

VERSIONE H 9

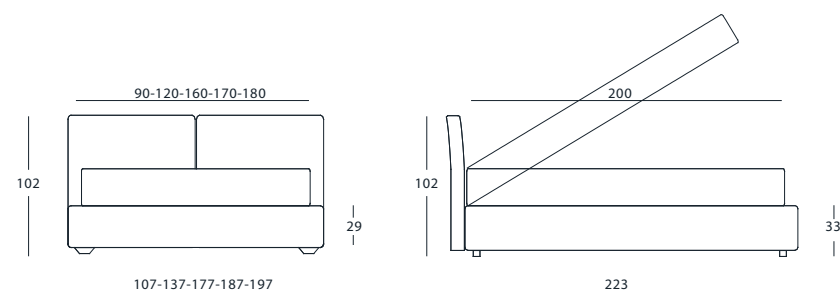

VERSIONE BOX

Letto completamente sfoderabile in tessuto ed ecopelle e testiera non sfoderabile in pelle, disponibile con basamento sottile o sagomato h.29 con telaio in legno o in alluminio con o senza box e c/box easy up, hands free o box spring. (vedi pag. 014).

Basamento sottile disponibile con piede vasetto, vasetto inclinato, inox, plaza, bridge, slitt, linea, gold e dorian. Piedi in legno disponibili anche laccati scala ral (vedi pag. 348) o rivestiti in tessuto o pelle.

Basamento sagomato h.29 disponibile con piede vasetto, cipolla, florence, tubetto, inox o system anche laccati scala ral (vedi pag. 349)

The bed cover made of fabric or eco-leather is completely removable, the headboard cover made of leather is non removable, available with thin or h.29 cm rounded bedbase, bedframe of solid wood or aluminum with or without storage box and with box easy up, hands free or box spring (see page 014).

Thin bedbase available with the following feet: vasetto, vasetto inclinati, inox, plaza, bridge, slitt, linea, gold and dorian. Wood feet available also lacquered in a color of the ral system (see page 348) or covered in fabric or leather.

Rounded bedbase h.29 available with the following feet: vasetto, cipolla, florence, tubetto, inox or system also lacquered in a color of the ral system (see page 349)

Cuciture, Seams:

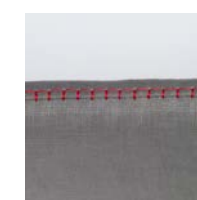

ricamo aperta
edge embroidery



ribattitura chiusa
ribattitura chiusa

Colori (vedi pag. 364)
Colors (see page 364)

Predisposto per materassi: l 90-120-160-170-180 x p 200

For mattresses: w 35 1/2" - 47 2/8" - 63" - 67" - 70 3/4" x d 78 3/4"

Full (double) size: predisposto per materassi l 137 x p 190 for mattresses w 54"x d 75"

Queen size: predisposto per materassi l 153 x p 203 for mattresses w 60"x d 80"

King size: predisposto per materassi l 193-198 x p 203 for mattresses w 76"x d 80"

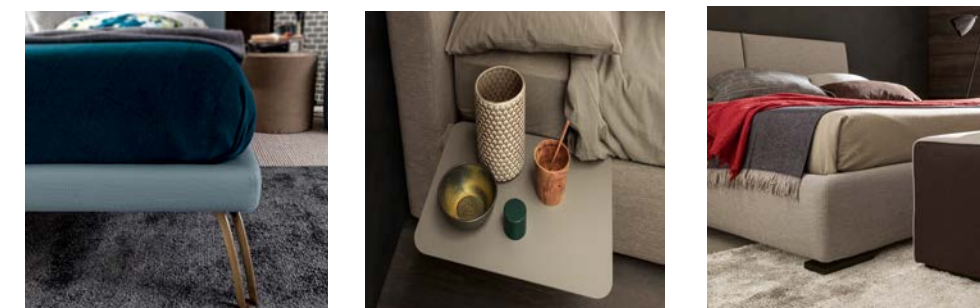

gaya new





gaya new h 9

Relax e riposo possono convivere nello stesso spazio: Gaya New è l'isola ideale per tuffarsi nelle pagine di un romanzo o per addormentarsi.

Relaxation and rest can cohabit the same space: Gaya New is the ideal island for becoming engrossed in the pages of a book or simply going to sleep.





corolle panchetta

Linee morbide e trapuntature, nulla è lasciato al caso nel design della panchetta corolle che aggiunge una sfumatura di novità ed eleganza al contesto in cui è inserita.

Soft shapes and quilting, nothing is left at random in the design of the Corolle bench, which adds a shade of newness and elegance to any room.



gaya new box

Un armonioso connubio tra funzionalità ed estetica nel letto tessile più tradizionale che cela al suo interno uno spazioso vano di contenimento.

A well-balanced encounter of functionality and good look in the more traditional fabric bed that conceals a spacious storage box inside.

oyster comò 3 + 3 cassetti piccoli





ares pouf

La vasta scelta dei colori e delle fantasie dei tessuti del pouf Ares faciliterà la personalizzazione di questi piccoli ma fondamentali oggetti d'arredo.

The wide choice of colours and patterns for pouf Ares allows the personalization of these little but essential pieces of furniture.





gaya new box

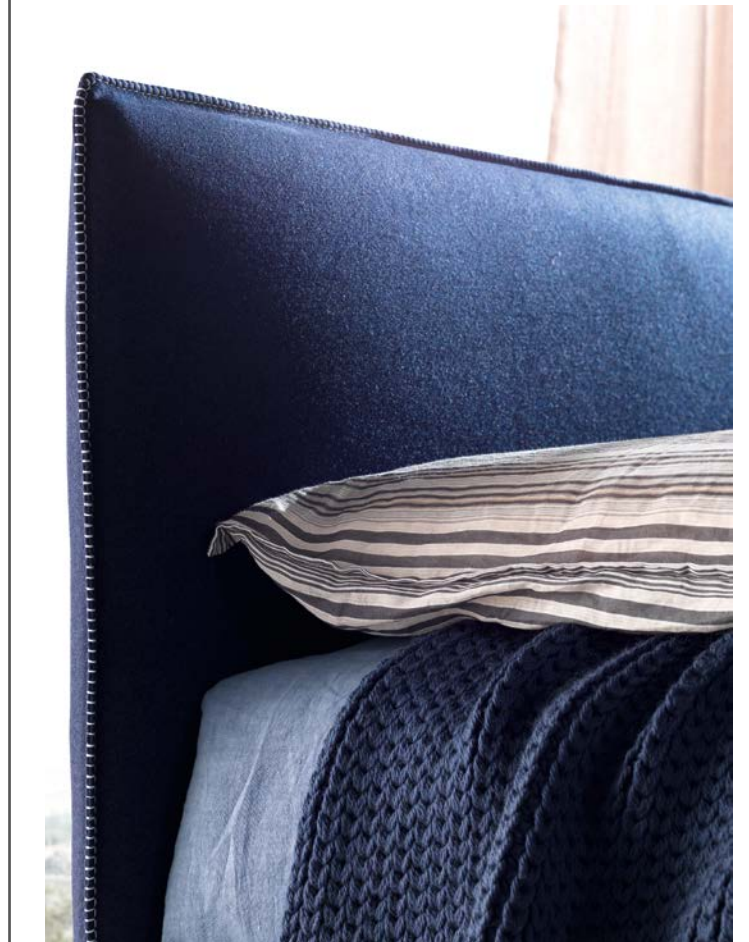

gaya new



technical details

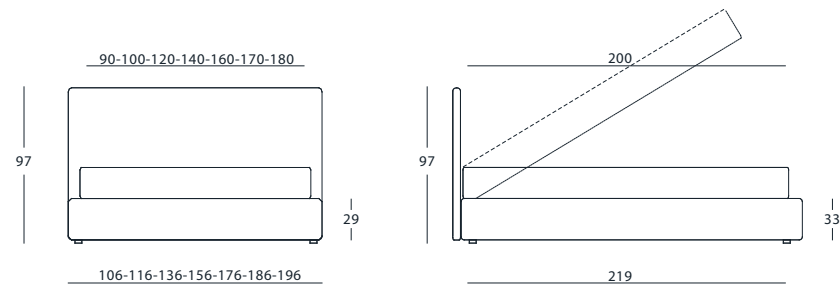

VERSIONE BOX

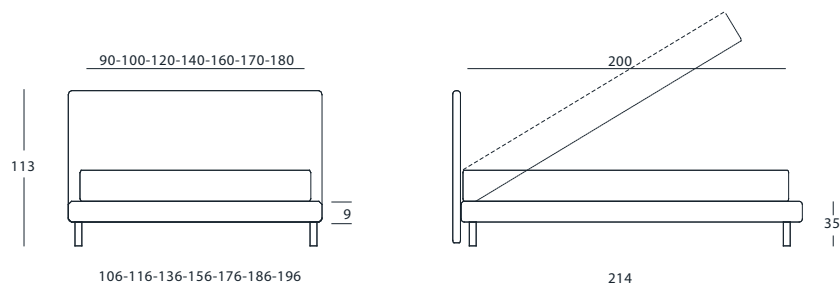

VERSIONE H9

Letto completamente sfoderabile in tessuto e testiera non sfoderabile in pelle ed ecopelle, disponibile con basamento sottile o sagomato h.29 con telaio in legno o in alluminio con o senza box e c/box easy up, hands free o box spring. (vedi pag. 014).

Basamento sottile disponibile con piede vasetto, vasetto inclinato, inox, plaza, bridge, slitt, linea, gold e dorian. Piedi in legno disponibili anche laccati scala ral o rivestiti in tessuto o pelle (vedi pag. 348).

Basamento sagomato h.29 disponibile con piede vasetto, cipolla, florence, tubetto, inox o system anche laccati scala ral (vedi pag. 349)

The bed cover made of fabric is completely removable, the headboard cover made of leather or eco-leather is non removable,

available with thin or h.29 cm rounded bedbase, bedframe of solid wood or aluminum with or without storage box and with box easy up, hands free or box spring (see page 014).

Thin bedbase available with the following feet: vasetto, vasetto inclinati, inox, plaza, bridge, slitt, linea, gold and dorian. Wood feet available also lacquered in a color of the ral system or covered in fabric or leather (see page 348).

Rounded bedbase h.29 available with following feet: vasetto, cipolla, florence, tubetto, inox or system also lacquered in a color of the ral system (see page 349)

Cuciture/Seams:



cucitura della sarta
sarta seam

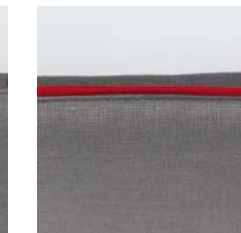

bordino morbido in contra-
sto contrast fabric edge



inserto passamaneria
with fabric strip



nervetto ribattitura inglese
normal seam

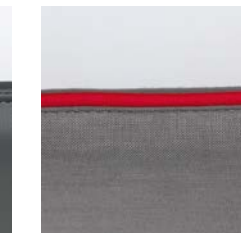

nervetto con coda di topo
piping coda di topo



nervetto con inserto in contrasto
inserted contrast edge



ricamo chiusa
flat embroidery



ricamo aperta
edge embroidery



taglio vivo
sharp cut



ribattitura chiusa
ribattitura chiusa

Colori cuc.ricamo

Colors for embroidery vedi/see page 364

Colori inserto passamaneria

Colors for fabric strip vedi/see page 366 - 367

Predisposto per materassi: l 90-100-120-140-160-170-180 x p 200

For mattresses: w 35 1/2" - 39 3/8" - 47 2/8" - 55 1/8" - 63" - 67" - 70 3/4" x d 78 3/4"

Full (double) size: predisposto per materassi l 137 x p 190 for mattresses w 54"x d 75"

Queen size: predisposto per materassi l 153 x p 203 for mattresses w 60"x d 80"

King size: predisposto per materassi l 193-198 x p 203 for mattresses w 76"x d 80"

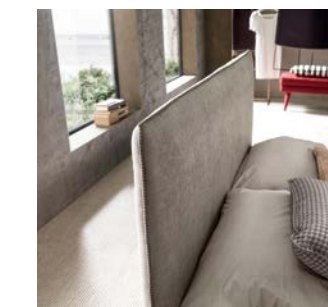

vola

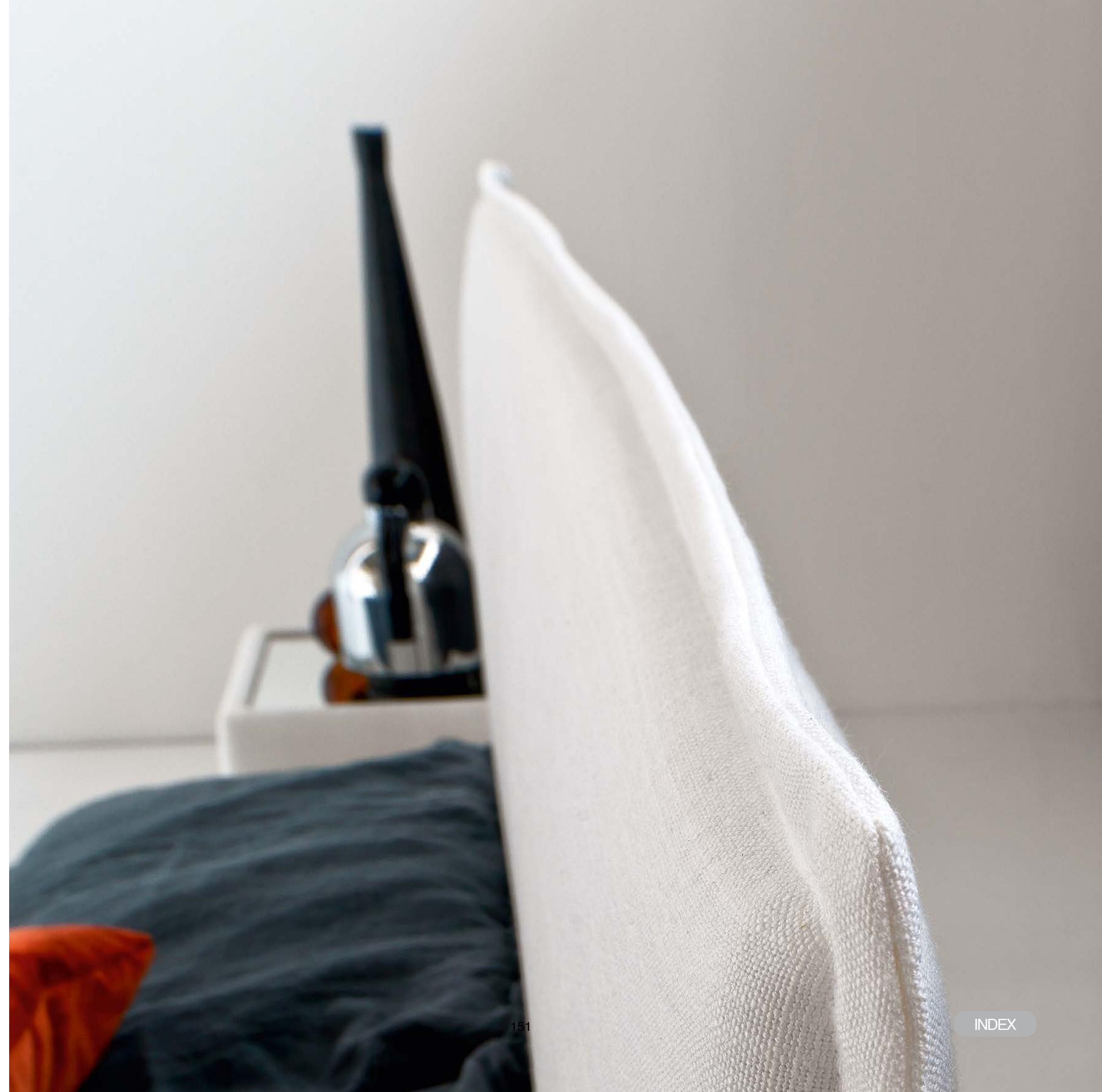

vola

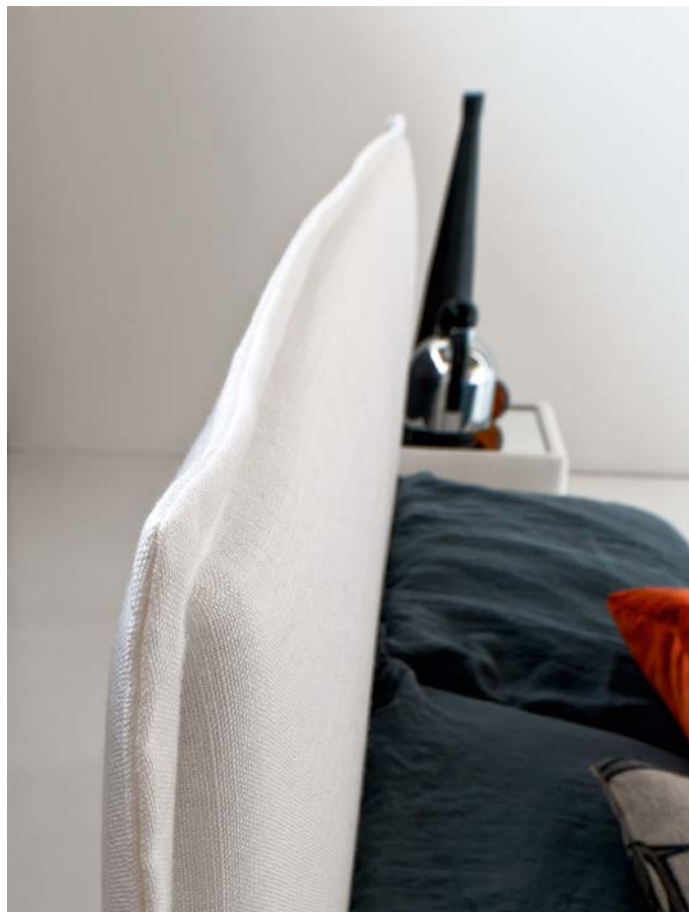



vola

Linee dinamiche ed eleganti, in un design unico e pieno di dettagli. Vola è un modello che unisce in sé classicità e innovazione: la testiera in tessuto diventa leggera come una foglia.

Dynamic and elegant lines, and a unique design full of details. Vola is a model that combines classic and innovative flair: its fabric headboard takes on the lightness of a leaf.





technical details

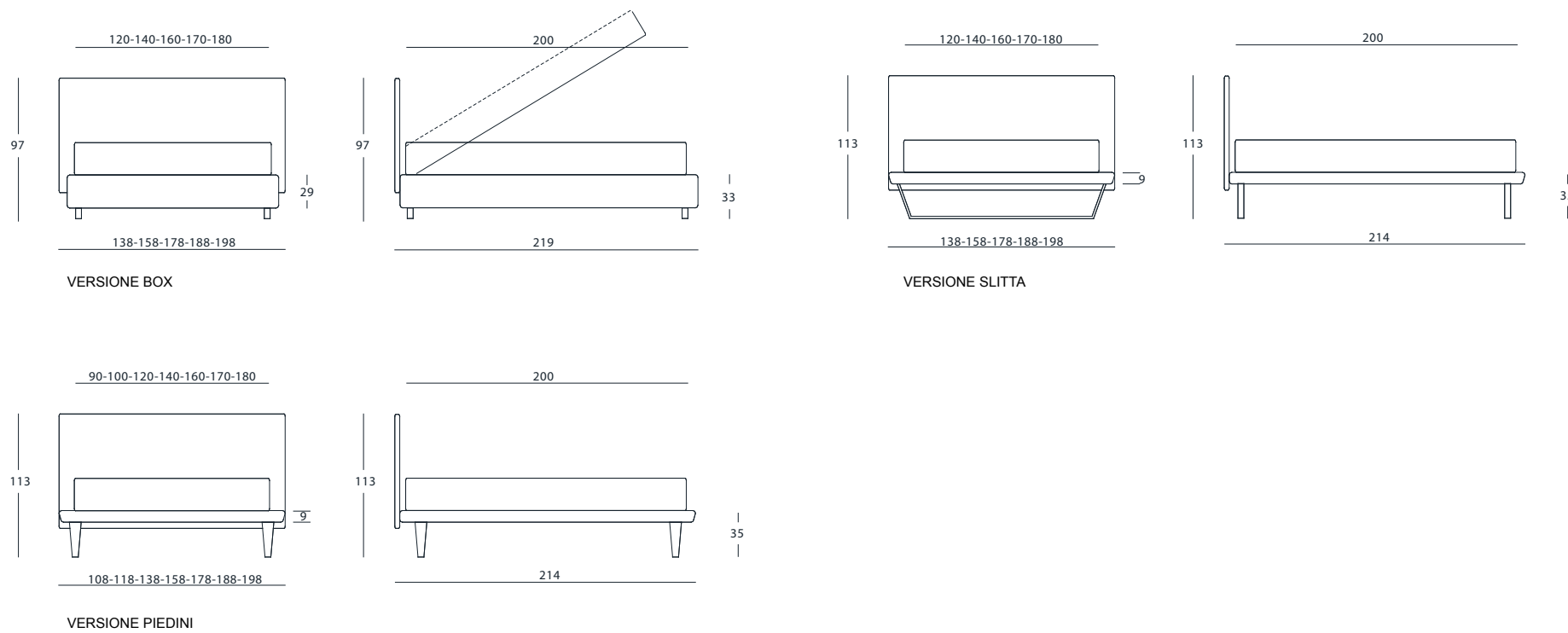

Letto completamente sfoderabile, disponibile con basamento vola o sagomato h.29 con telaio in legno o in alluminio con o senza box e c/box easy up, hands free o box spring. (vedi pag. 014).

Basamento vola disponibile con piede vasetto, vasetto inclinato, inox, plaza, bridge, slitt, linea, gold e dorian. Piedi in legno disponibili anche laccati scala ral o rivestiti in tessuto o pelle (vedi pag. 348).

Basamento sagomato h.29 disponibile con piede vasetto, cipolla, florence, tubetto, inox o system anche laccati scala ral (vedi pag. 349)

The bed cover is completely removable, available with thin or h.29 cm rounded bedbase, bedframe of solid wood or aluminum with or without storage box and with box easy up, hands free or box spring (see page 014).

Vola bedbase available with the following feet: vasetto, vasetto inclinati, inox, plaza, bridge, slitt, linea, gold and dorian. Wood feet available also lacquered in a color of the ral system or covered in fabric or leather (see page 348).

Rounded bedbase h.29 available with the following feet: vasetto, cipolla, florence, tubetto, inox or system also lacquered in a color of the ral system (see page 349)

Cuciture/seams:
(taglio vivo solo con pelle o tess. Shabby)
(sharp cut is only available in leather or fabric Shabby)



taglio vivo
sharp cut

Predisposto per materassi: l 120-140-160-170-180 x p 200

For mattresses: w 47 2/8" – 55 1/8" – 63" – 67" – 70 3/4" x d 78 3/4"

Full (double) size: predisposto per materassi l 137 x p 190 for mattresses w 54"x d 75"

Queen size: predisposto per materassi l 153 x p 203 for mattresses w 60"x d 80"

King size: predisposto per materassi l 193-198 x p 203 for mattresses w 76"x d 80"



smile



smile



smile



technical details

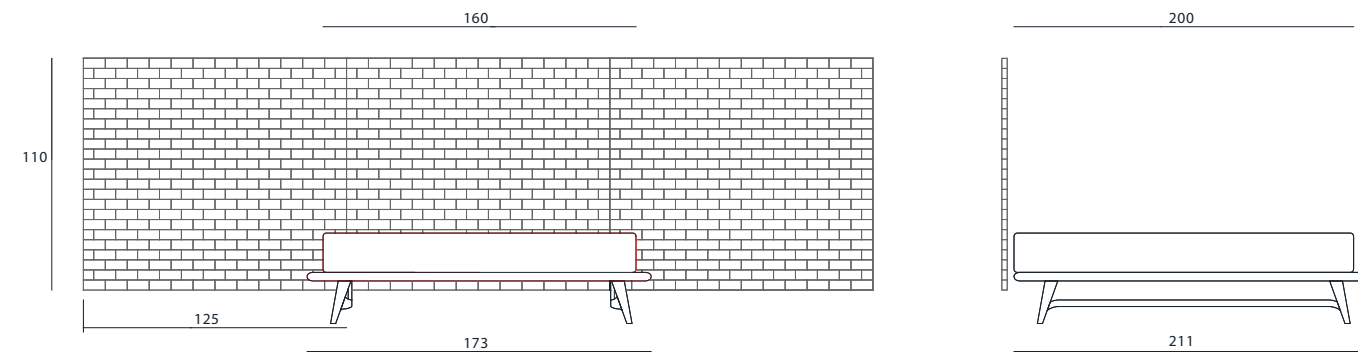

VERSIONE CON PANNELLI

Sommier completamente sfoderabile, testiera a progetto, predisposta con fissaggio a muro, disponibile con basamento smile, sottile o sagomato h.20, h.29 con telaio in legno o in alluminio con o senza box e c/box easy up, hands free o box spring. (vedi pag. 014).

Basamento smile o sottile disponibile con piede vasetto, vasetto inclinato, inox, plaza, bridge, slitt, linea, gold e dorian. Piedi in legno disponibili anche laccati scala ral o rivestiti in tessuto o pelle (vedi pag. 348).

Basamento sagomato h.20 o h.29 disponibile con piede vasetto, cipolla, florence, tubetto, inox o system anche laccati scala ral (vedi pag. 349)

The bedbase cover is completely removable, Tailor-made headboard, to be fixed to the wall, available with smile, thin bedbase or h.20, h.29 cm rounded bedbase, bedframe of solid wood or aluminum with or without storage box and with box easy up, hands free or box spring (see page 014).

Smile or thin bedbase available with the following feet: vasetto, vasetto inclinati, inox, plaza, bridge, slitt, linea, gold and dorian. Wood feet available also lacquered in a color of the ral system or covered in fabric or leather (see page 348).

Rounded bedbase h.20 or h.29 available with the following feet: vasetto, cipolla, florence, tubetto, inox or system also lacquered in a color of the ral system (see page 349)

Predisposto per materassi: l 90-100-120-140-160-170-180 x p 200

For mattresses: w 35 1/2" - 39 3/8" - 47 2/8" - 55 1/8" - 63" - 67" - 70 3/4" x d 78 3/4"

Full (double) size: predisposto per materassi l 137 x p 190 for mattresses w 54"x d 75"

Queen size: predisposto per materassi l 153 x p 203 for mattresses w 60"x d 80"

King size: predisposto per materassi l 193-198 x p 203 for mattresses w 76"x d 80"

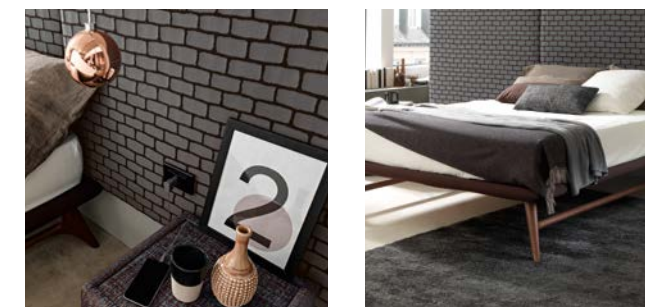

iorca





iorca h 9

Le grandi proporzioni dei cuscini di testata diventano l'elemento caratterizzante principale di una proposta che interpreta la camera da letto come spazio sempre più personale (e personalizzabile), in cui dedicarsi al relax.

The huge cushions of the headboard are the central feature of a bed that interprets the bedroom as a more and more personal (and personalisable) space where you can relax yourself.



dinghy pouf

jubilè comò 3 + 3 cassetti



iorca box

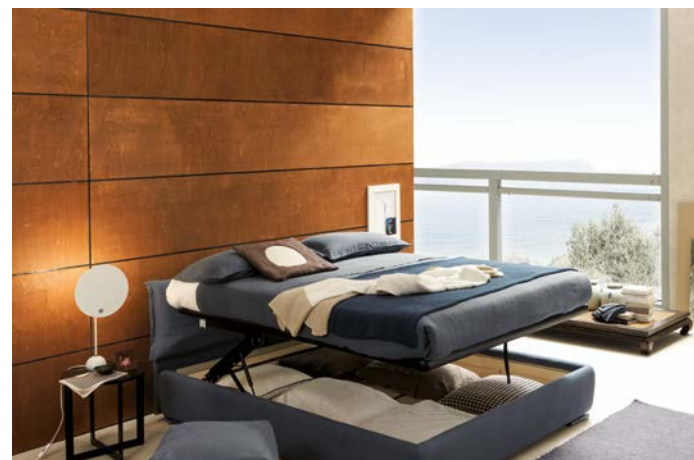



iorca chic

L'uso sapiente dei diversi materiali rende Iorca Chic un modello adatto a qualsiasi esigenza. La morbidezza del tessuto e le sinuosità delle sue forme si scontrano piacevolmente con la durezza della struttura in metallo che nasconde un comodo vano contenitore.

The skilful use of different materials make Iorca Chic bed a model suitable for any need. The softness of the fabric and the sinuosity of its shape pleasantly struggle with the squared shape of the bedbase that conceals a useful storage box.





slim comodino

Fresco, confortevole, caldo e bello sono alcune delle parole che ci vengono in mente quando pensiamo a questo letto particolare con un design accattivante. Iorca Chic è realizzabile unicamente con alcuni tessuti selezionati del nostro campionario, non è realizzabile in pelle o eco-pelle.

E poiché gli opposti si attraggono, ben si sposa la morbidezza del tessuto con la rigidità del tavolino Slim: sottile, rigoroso, elegante sembra sospendersi nel vuoto.

Fresh, comfortable, embracing and beautiful are some of the words suggested by this original and fascinating bed. Iorca Chic is available only in some selected fabrics of our sample book and not in leather or eco-leather.

Opposites attract each other: therefore the soft fabric cover marries the rigidity of Slim side table: thin, rigorous, elegant, it seems to be dangling in space.



te

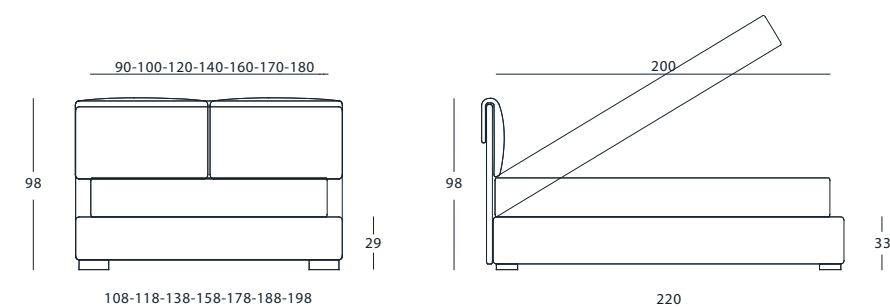

VERSIONE BOX

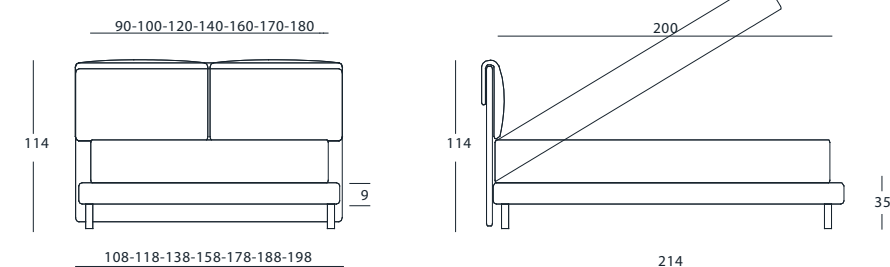

VERSIONE H 9

Letto completamente sfoderabile in tessuto ed ecopelle, testiera non sfoderabile in pelle disponibile con basamento sottile o sagomato h.29 con telaio in legno o in alluminio con o senza box e c/box easy up, hands free o box spring. (vedi pag. 014).

Basamento sottile disponibile con piede vasetto, vasetto inclinato, inox, plaza, bridge, slitt, linea, gold e dorian. Piedi in legno disponibili anche laccati scala ral o rivestiti in tessuto o pelle (vedi pag. 348).

Basamento sagomato h.29 disponibile con piede vasetto, cipolla, florence, tubetto, inox o system anche laccati scala ral (vedi pag. 349)

The bed cover made of fabric or eco-leather is completely removable, the headboard cover made of leather is non removable, available with thin or h.29 cm rounded bedbase, bedframe of solid wood or aluminum with or without storage box and with box easy up, hands free or box spring (see page 014).

Thin bedbase available with the following feet: vasetto, vasetto inclinati, inox, plaza, bridge, slitt, linea, gold and dorian. Wood feet available also lacquered in a color of the ral system or covered in fabric or leather (see page 348).

Rounded bedbase h.29 available with the following feet: vasetto, cipolla, florence, tubetto, inox or system also lacquered in a color of the ral system (see page 349)

Cuciture/Seam:



lineare stretta
linear seam

Colori cuc.lineare

Colors for linear seam vedi/see page 364-365

Predisposto per materassi: l 90-100-120-140-160-170-180 x p 200

For mattresses: w 35 1/2" - 39 3/8" - 47 2/8" - 55 1/8" - 63" - 67" - 70 3/4" x d 78 3/4"

Full (double) size: predisposto per materassi l 137 x p 190 for mattresses w 54"x d 75"

Queen size: predisposto per materassi l 153 x p 203 for mattresses w 60"x d 80"

King size: predisposto per materassi l 193-198 x p 203 for mattresses w 76"x d 80"

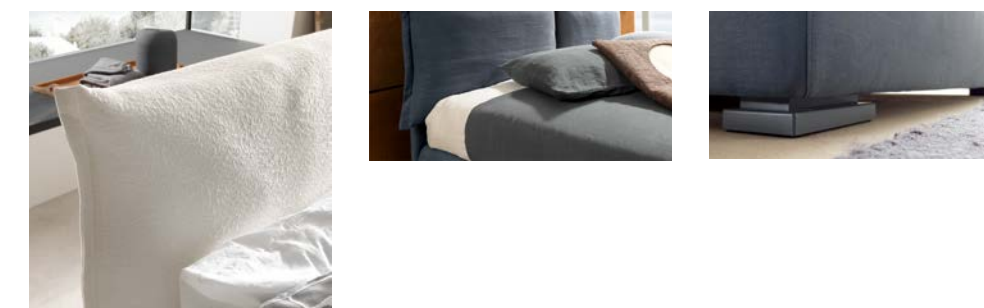



technical details

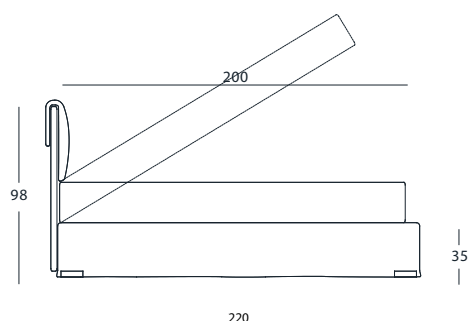
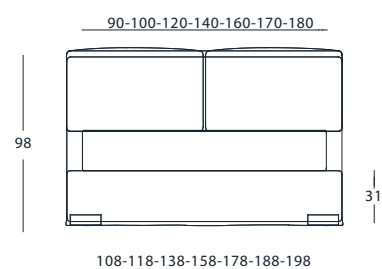

Letto completamente sfoderabile, disponibile con telaio in legno o in alluminio con o senza box e c/box easy up, hands free o box spring. (vedi pag. 014).

Realizzabile unicamente nei tessuti: alassio, aspern, beat, cotone, doublebuk, le lin, lin leger, linone, nico, outmap, pesba, pure wool, reef, reloaded, rigatto, rosa, ruskin, saint moritz, shabby, sing, spring, texas-lalique, tigullio, vanilla e wool.

Disponibile con piede vasetto, cipolla, florence, tubetto, inox o system anche laccati scala ral (vedi pag 349)

The bed cover is completely removable, available with bedframe of solid wood or aluminum with or without storage box and with box easy up, hands free or box spring (see page 014).

The bed cover is available only in the following fabrics: alassio, aspern, beat, cotone, doublebuk, le lin, lin leger, linone, nico, outmap, pesba, pure wool, reef, reloaded, rigatto, rosa, ruskin, saint moritz, shabby, sing, spring, texas-lalique, tigullio, vanilla and wool.

Available with feet plastica, vasetto, cipolla, Florence, tubetto, inox or system which can be lacquered in any colour ref. ral system (see pag. 349)

Cuciture/Seams:

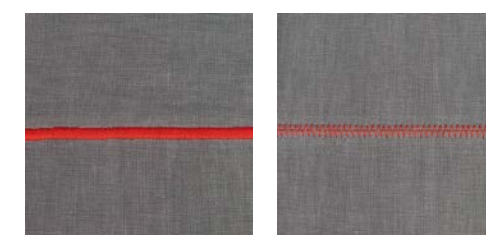

lineare stretta
linear seam

lineare zig zag
zig zag linear seam

Colori cuc.lineare
Colors for linear seam vedi/see page 364-365

Predisposto per materassi: l 90-100-120-140-160-170-180 x p 200

For mattresses: w 35 1/2" – 39 3/8" – 47 2/8" – 55 1/8" – 63" – 67" – 70 3/4" x d 78 3/4"

Full (double) size: predisposto per materassi l 137 x p 190 for mattresses w 54"x d 75"

Queen size: predisposto per materassi l 153 x p 203 for mattresses w 60"x d 80"

King size: predisposto per materassi l 193-198 x p 203 for mattresses w 76"x d 80"



moonito



moonito

La notte come dimensione privata, ricca di suggestioni, da esplorare attraverso le sensazioni dei materiali.

Night is a private moment, full of suggestions you can experience through the sensations given by materials.







technical details

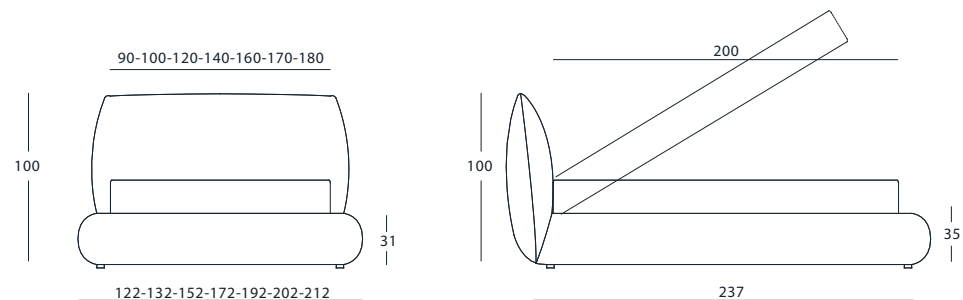

Letto completamente sfoderabile, disponibile con telaio in legno o in alluminio con o senza box e c/box easy up, hands free o box spring. (vedi pag. 14).

Disponibile con piede vasetto, cipolla o system anche laccati scala ral (vedi pag. 349)

The bed cover is completely removable, available with bedframe of solid wood or aluminum with or without storage box and with box easy up, hands free or box spring (see page 14).

Available with feet vasetto, cipolla or system which can be lacquered in any colour ref. ral syestem (see pag. 349)

Cuciture/Seams:



(taglio vivo solo con pelle o tess. shabby)
(sharp cut is only available in leather or fabric Shabby)

Colori cuc.ricamo
Colors for embroidery vedi/see page 364

Colori inserto passamaneria
Colors for fabric strip vedi/see page 366 - 367

Predisposto per materassi: l 90-100-120-140-160-170-180 x p 200

For mattresses: w 35 1/2" – 39 3/8" – 47 2/8" – 55 1/8" – 63" – 67" – 70 3/4" x d 78 3/4"

Full (double) size: predisposto per materassi l 137 x p 190 for mattresses w 54"x d 75"

Queen size: predisposto per materassi l 153 x p 203 for mattresses w 60"x d 80"

King size: predisposto per materassi l 193-198 x p 203 for mattresses w 76"x d 80"

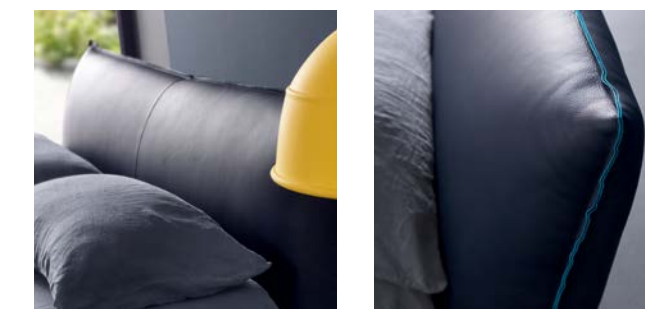

nido

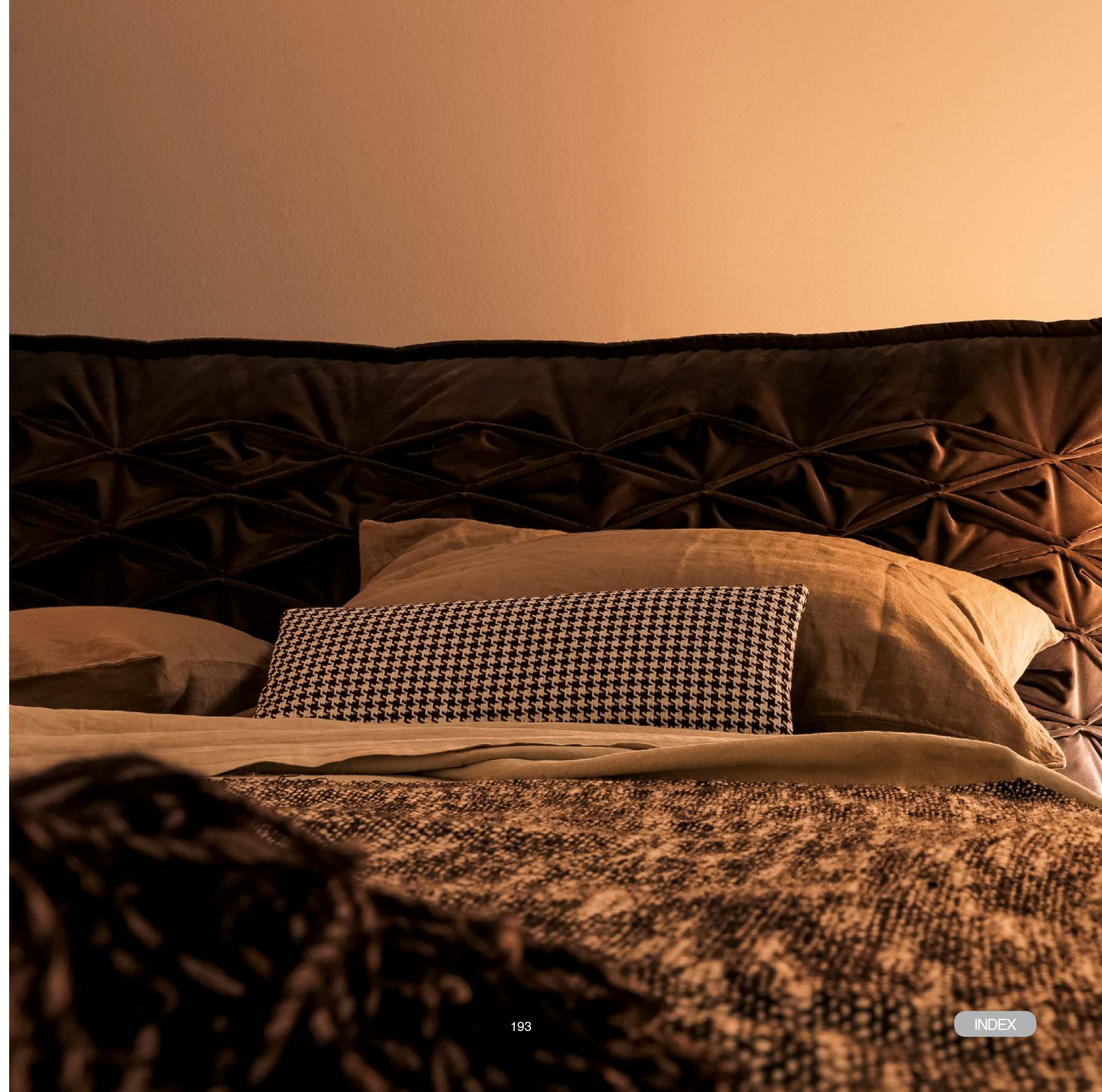



nido

Il modello Nido esprime nella testiera tutto l'amore e la cura per i dettagli e per le lavorazioni artigianali, fatte per impreziosire e rendere unico l'ambiente più intimo della casa.

Bed model Nido embodies in the geometric pattern of the headboard our love and attention for details and for craft finishings that enrich and personalise the more intimate room of the house.





ares pouf con dock station





Letto completamente sfoderabile, disponibile con telaio in legno o in alluminio con o senza box e c/box easy up, hands free o box spring. (vedi pag. 14).

Realizzabile unicamente in tessuto.
Disponibile con piede vasetto, cipolla o system anche laccati scala ral (vedi pag. 349)

The bed cover is completely removable,
available with bedframe of solid wood or aluminum with or without storage box and with box easy up, hands free or box spring (see page 14).

The bed cover is available only in fabric.
Available with feet vasetto, cipolla or system which can be lacquered in any colour ref. ral system (see pag. 349)

Predisposto per materassi: l 90-100-120-140-160-170-180 x p 200

For mattresses: w 35 1/2" – 39 3/8" – 47 2/8" – 55 1/8" – 63" – 67" – 70 3/4" x d 78 3/4"

Full (double) size: predisposto per materassi l 137 x p 190 for mattresses w 54"x d 75"

Queen size: predisposto per materassi l 153 x p 203 for mattresses w 60"x d 80"

King size: predisposto per materassi l 193-198 x p 203 for mattresses w 76"x d 80"

technical details

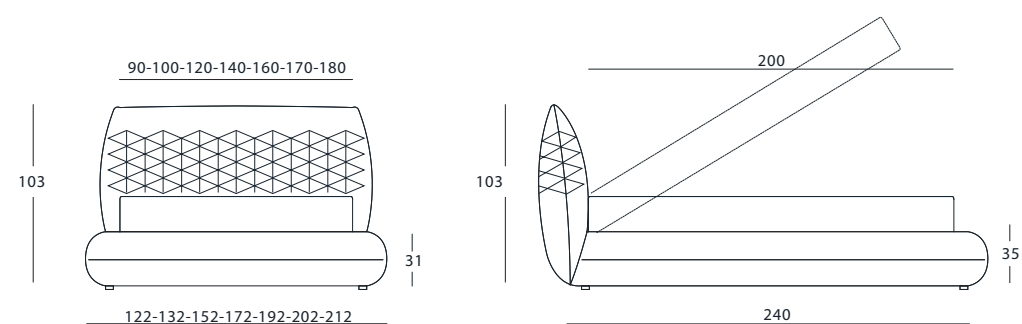

metropolitan



metropolitan

La testiera del letto Metropolitan si caratterizza per la morbidezza della linea che la disegna e che si ritrova anche nel ring rivestito in tessuto.

The distinguishing feature of the headboard on the Metropolitan bed is the soft line of its design: soft lines repeated in the fabric-covered surround.





metropolitan



metropolitan

Letto di design la cui particolarità è data dalla continuità di linea tra testiera e giroletto.

A bed with a particularly strong design. It's characterised by a continuity of lines between the headboard and the ring.





metropolitan chic



cube pouf



metropolitan



technical details

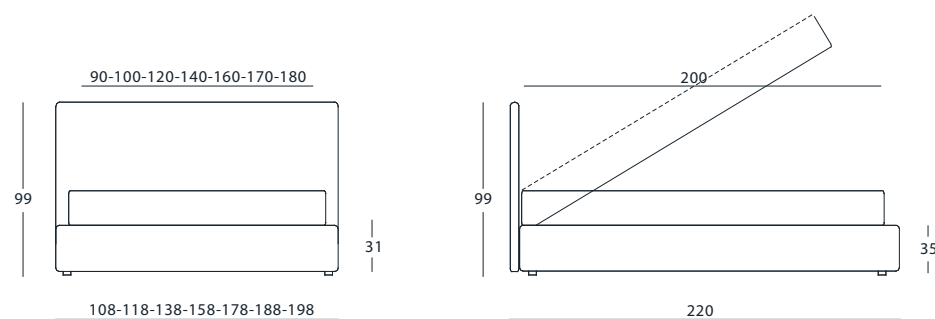

Letto completamente sfoderabile, disponibile con telaio in legno o in alluminio con o senza box e c/box easy up, hands free o box spring. (vedi pag. 14).

Cucitura taglio vivo disponibile con pelle o tessuto shabby.

Disponibile con piede vasetto, cipolla, tubetto, inox o system anche laccati scala ral (vedi pag. 349)

The bed cover is completely removable, available with bedframe of solid wood or aluminum with or without storage box and with box easy up, hands free or box spring (see page 14).

Sharp cut is only available in leather or fabric shabby.

Available with feet vasetto, cipolla, tubetto, inox or system which can be lacquered in any colour ref. ral system (see pag 349)

Cuciture/Seams:



lineare stretta
linear seam



lineare zig zag
ziz zag linear seam



nervetto ribattitura inglese
normal seam



ricamo chiusa
flat embroidery

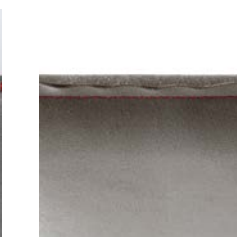

taglio vivo
sharp cut

Colori cuc.ricamo

Colors for embroidery vedi/see pag. 364

Colori cuc.lineare

Colors for linear seam vedi/see page 364 - 365

Predisposto per materassi: l 90-100-120-140-160-170-180 x p 200

For mattresses: w 35 1/2" - 39 3/8" - 47 2/8" - 55 1/8" - 63" - 67" - 70 3/4" x d 78 3/4"

Full (double) size: predisposto per materassi l 137 x p 190 for mattresses w 54" x d 75"

Queen size: predisposto per materassi l 153 x p 203 for mattresses w 60" x d 80"

King size: predisposto per materassi l 193-198 x p 203 for mattresses w 76" x d 80"





technical details

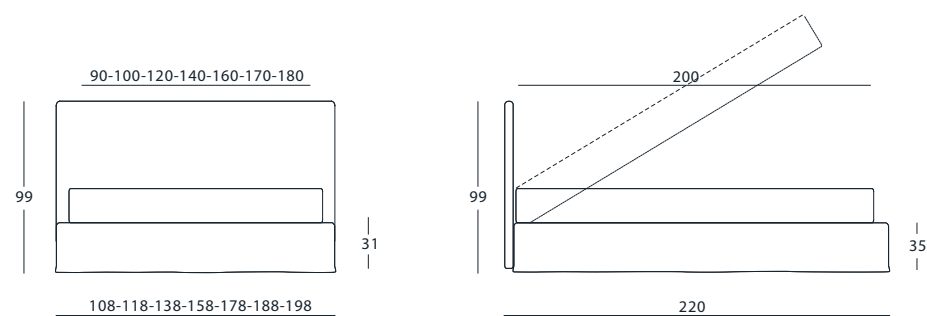

Letto completamente sfoderabile, disponibile con telaio in legno o in alluminio con o senza box e c/box easy up, hands free o box spring. (vedi pag. 14).

Realizzabile unicamente nei tessuti: alassio, aspern, beat, cotone, doublebuk, le lin, lin leger, linone, nico, outmap, pesba, pure wool, reef, reloaded, rigatto, rosa, ruskin, saint moritz, shabby, sing, spring, texas-lalique, tigullio, vanilla e wool.

Disponibile con piede vasetto, cipolla, tubetto, inox o system anche laccati scala ral (vedi pag. 349)

The bed cover is completely removable, available with bedframe of solid wood or aluminum with or without storage box and with box easy up, hands free or box spring (see page 14).

The bed cover is available only in the following fabrics: alassio, aspern, beat, cotone, doublebuk, le lin, lin leger, linone, nico, outmap, pesba, pure wool, reef, reloaded, rigatto, rosa, ruskin, saint moritz, shabby, sing, spring, texas-lalique, tigullio, vanilla and wool.

Available with feet plastica, vasetto, cipolla, tubetto, inox or system which can be lacquered in any colour ref. ral system (see page 349)

Cuciture/Seams:



lineare stretta
linear seam



lineare zig zag
ziz zag linear seam

Colori cuc.lineare

Colors for linear seam vedi/see page 364 - 365

Predisposto per materassi: l 90-100-120-140-160-170-180 x p 200

For mattresses: w 35 1/2" - 39 3/8" - 47 2/8" - 55 1/8" - 63" - 67" - 70 3/4" x d 78 3/4"

Full (double) size: predisposto per materassi l 137 x p 190 for mattresses w 54"x d 75"

Queen size: predisposto per materassi l 153 x p 203 for mattresses w 60"x d 80"

King size: predisposto per materassi l 193-198 x p 203 for mattresses w 76"x d 80"



sun



sun





sun chic

Il letto Sun concretizza il desiderio di semplicità ed originalità, l'unico ornamento è nella testiera, ritmata dalle particolari cuciture laterali che ne sottolineano le grazie ed il design.

Sun bed meets your wish for simple originality, just the headboard with unique open seams emphasizes its outline and design.





sun pouf

Soffice, morbido, irregolare il pouf "sun" dà un'aria giocosa e stravagante al contesto in cui viene inserito.

La sapiente manifattura unita alla vasta gamma di tessuti disponibili, rende "sun" un oggetto estremamente versatile.

Soft, tender, irregular "sun" pouf gives a playful and peculiar air to the context it is in.

Sun is an extremely versatile object thanks to the accurate handmade workmanship united to the wide range of available fabrics.

sun



technical details

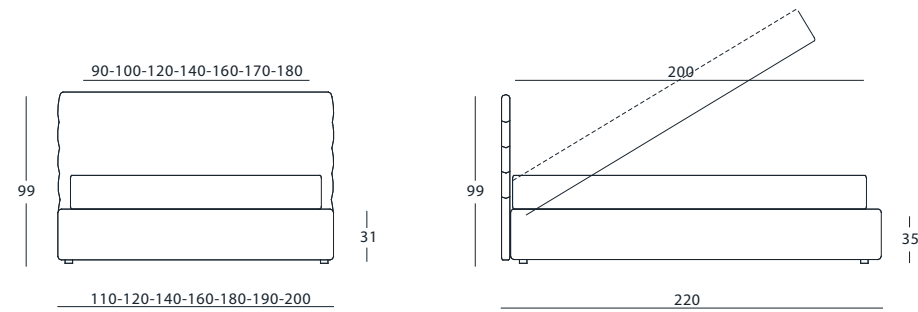

230

Letto completamente sfoderabile, disponibile con telaio in legno o in alluminio con o senza box e c/box easy up, hands free o box spring. (vedi pag. 14).

Realizzabile unicamente in tessuto.

Disponibile con piede vasetto, cipolla, tubetto, inox o system anche laccati scala ral (vedi pag. 349)

The bed cover is completely removable, available with bedframe of solid wood or aluminum with or without storage box and with box easy up, hands free or box spring (see page 14).

The bed cover is available only in fabric.

Available with feet vasetto, cipolla, tubetto, inox or system which can be lacquered in any colour ref. ral system (see page 349)

Predisposto per materassi: l 90-100-120-140-160-170-180 x p 200

For mattresses: w 35 1/2" – 39 3/8" – 47 2/8" – 55 1/8" – 63" – 67" – 70 3/4" x d 78 3/4"

Full (double) size: predisposto per materassi l 137 x p 190 for mattresses w 54" x d 75"

Queen size: predisposto per materassi l 153 x p 203 for mattresses w 60" x d 80"

King size: predisposto per materassi l 193-198 x p 203 for mattresses w 76" x d 80"

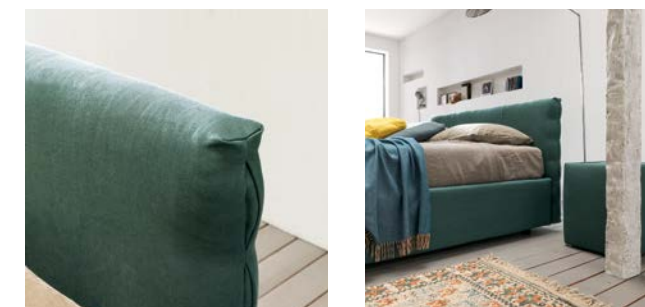

231

INDEX



technical details

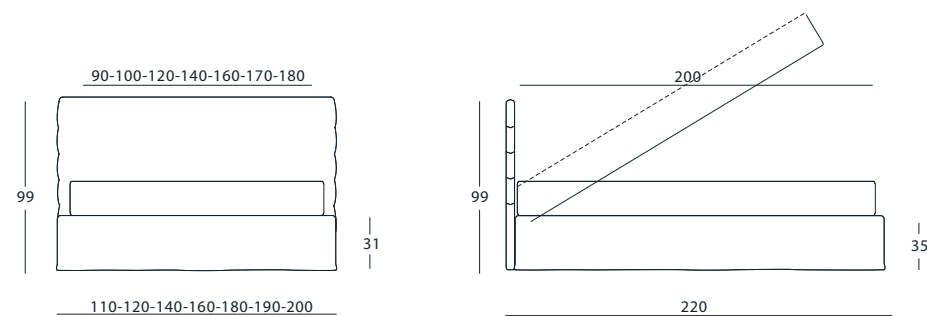

Letto completamente sfoderabile, disponibile con telaio in legno o in alluminio con o senza box e c/box easy up, hands free o box spring. (vedi pag. 14).

Realizzabile unicamente nei tessuti: alassio, aspern, beat, cotone, doublebuk, le lin, lin leger, linone, nico, outmap, pesba, pure wool, reef, reloaded, rigatto, rosa, ruskin, saint moritz, shabby, sing, spring, texas-lalique, tigullio, vanilla e wool.

Disponibile con piede vasetto, cipolla, tubetto, inox o system anche laccati scala ral (vedi pag. 349)

The bed cover is completely removable, available with bedframe of solid wood or aluminum with or without storage box and with box easy up, hands free or box spring (see page 14). The bed cover is available only in the following fabrics:

alassio, aspern, beat, cotone, doublebuk, le lin, lin leger, linone, nico, outmap, pesba, pure wool, reef, reloaded, rigatto, rosa, ruskin, saint moritz, shabby, sing, spring, texas-lalique, tigullio, vanilla and wool.

Available with feet plastica, vasetto, cipolla, tubetto, inox or system which can be lacquered in any colour ref. ral system (see page 349)

Cuciture/Seams:



lineare stretta
linear seam



lineare zig zag
ziz zag linear seam

Colori cuc.lineare su gonnellina
Colors for linear seam on the skirt vedi/see page 364 - 365

Predisposto per materassi: l 90-100-120-140-160-170-180 x p 200

For mattresses: w 35 1/2" - 39 3/8" - 47 2/8" - 55 1/8" - 63" - 67" - 70 3/4" x d 78 3/4"

Full (double) size: predisposto per materassi l 137 x p 190 for mattresses w 54"x d 75"

Queen size: predisposto per materassi l 153 x p 203 for mattresses w 60"x d 80"

King size: predisposto per materassi l 193-198 x p 203 for mattresses w 76"x d 80"

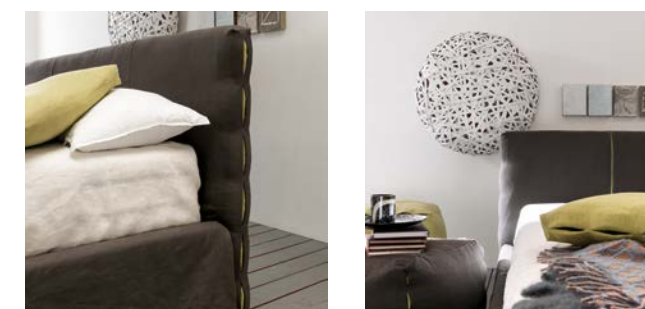

cubed





cubed color



La varietà dei colori per una zona notte all'insegna della massima libertà stilistica. L'ampia gamma di suggestioni cromatiche associate a un design unico e originale rendono il modello Cu.bed Color un letto fuori dal comune.

The colour variety characterises a bedroom with the highest stylistic freedom. The wide selection of chromatic suggestions together with a unique and original design make model Cu.bed Color an extraordinary choice.



listeren pouf



cubed





La palette cromatica è in continuo aggiornamento: dalle tinte più neutre ai colori più originali. Cu.bed diventa così una proposta in grado di interpretare al meglio i trend stilistici.

The colour palette is changing continuously, from the most neutral to the newest colours. Cu.bed is the best solution to interpret the fashion trends.

cubed



Letto non sfoderabile, realizzabile unicamente in pelle, ecopelle o alcantara.

La disposizione dei moduli può variare.

The bed cover is non removable, available only in leather, eco-leather or alcantara.

The sequence high/low may vary

Predisposto per materassi: l 90-100-120-140-160-170-180 x p 200

For mattresses: w 35 1/2" – 39 3/8" – 47 2/8" – 55 1/8" – 63" – 67" – 70 3/4" x d 78 3/4"

technical details

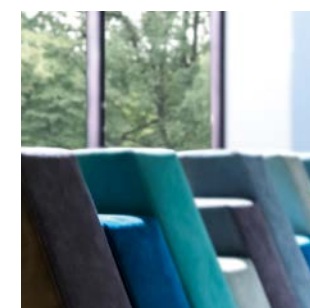
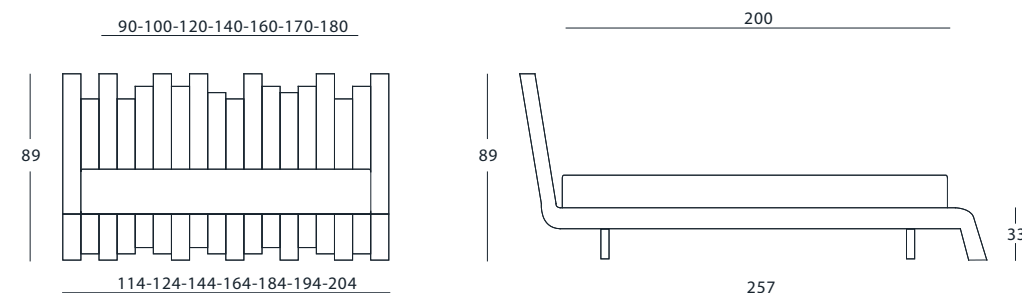

miami





miami





Letto completamente sfoderabile e testiere non sfoderabili in pelle ed ecopelle.

The bed cover is completely removable, the headboard cover made of leather or eco-leather is non removable.

Predisposto per materassi: l 230 x p 230

For mattresses: w 90 9/16" x d 90 9/16"

technical details

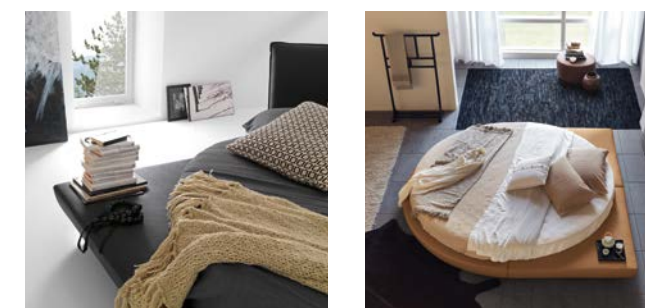
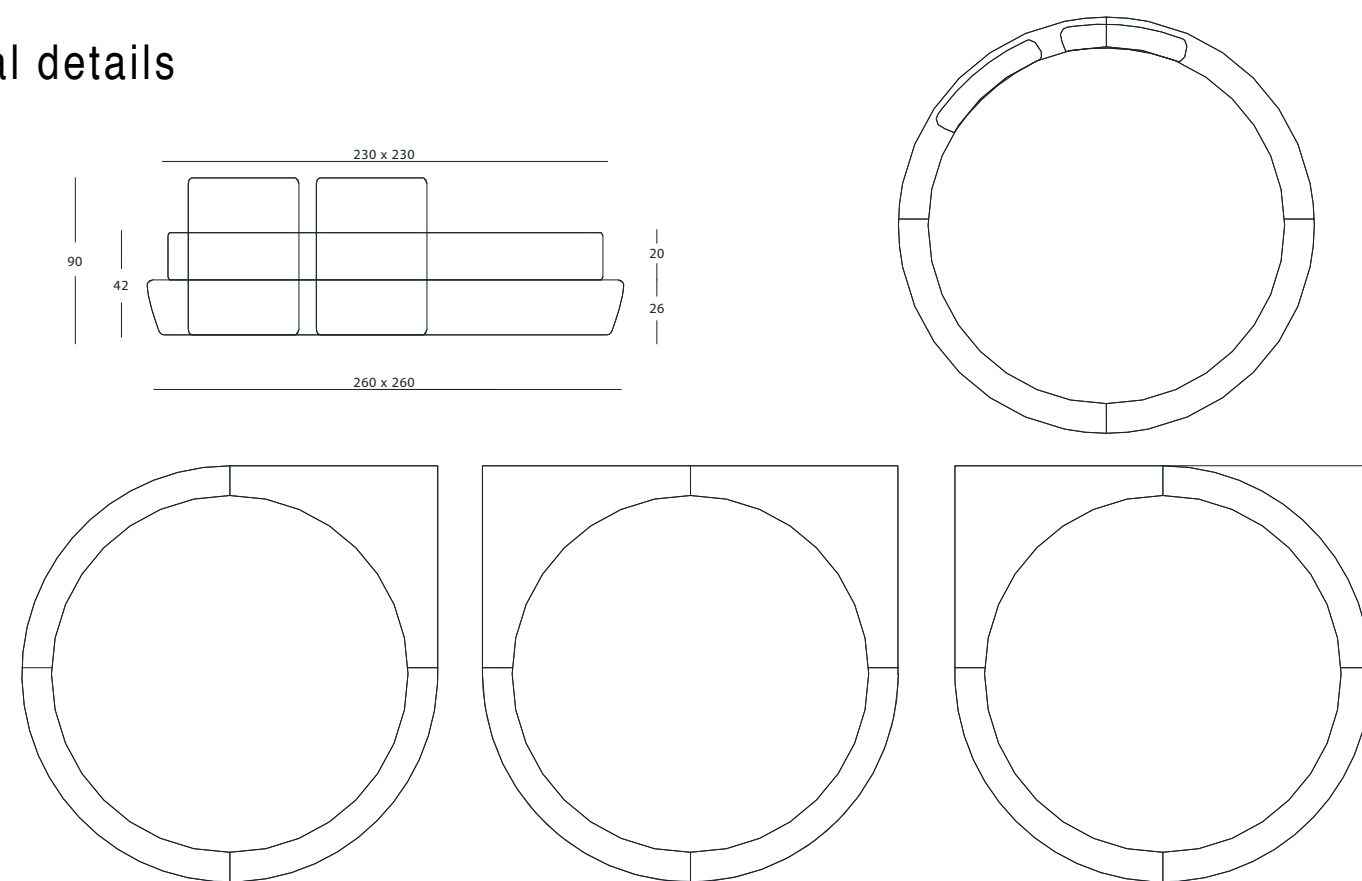

maison

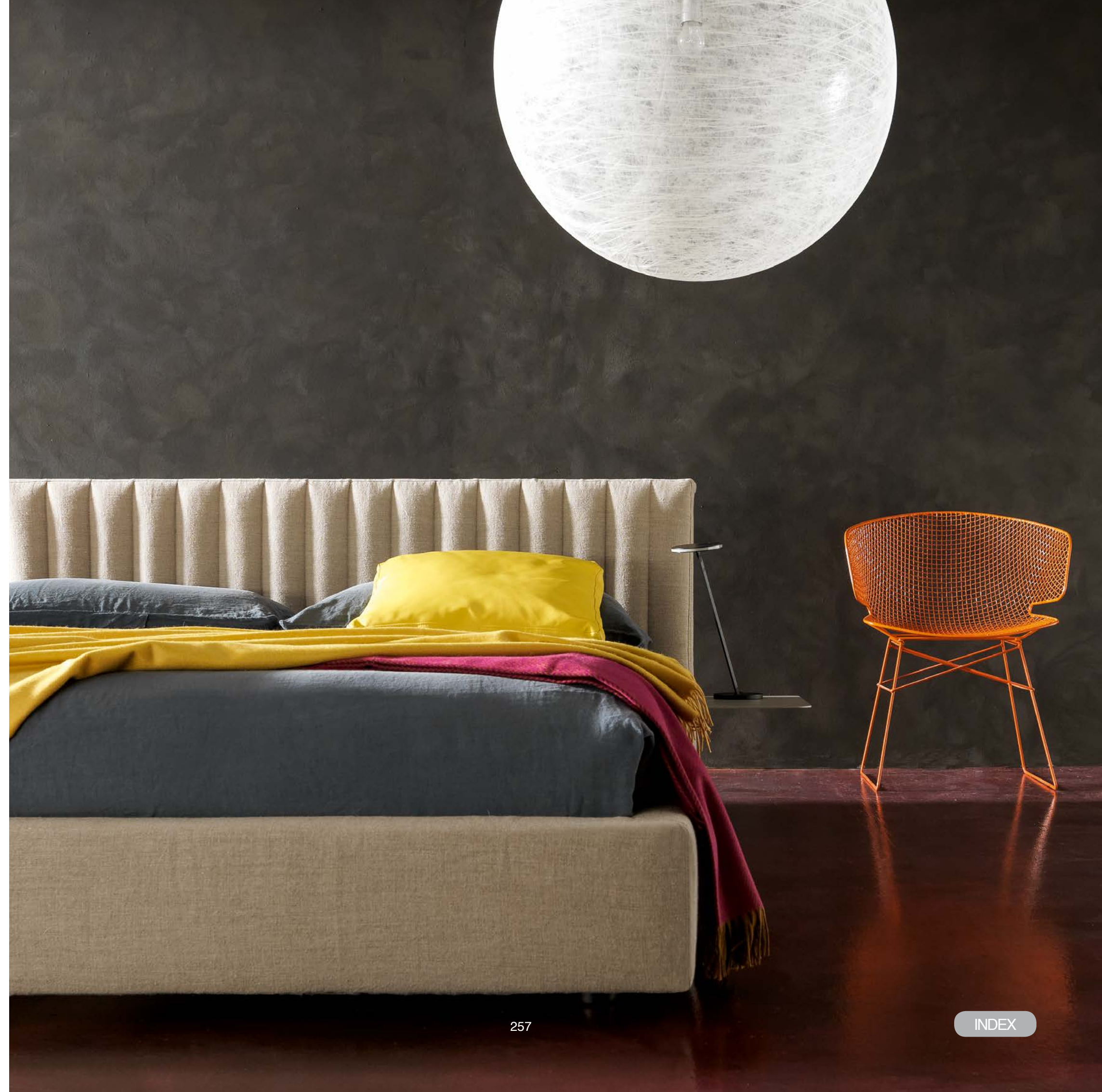

maison



258



259

INDEX



Letto completamente sfoderabile in tessuto e testiera non sfoderabile in pelle ed ecopelle, disponibile con o senza box e c/box easy up.

Disponibile con piede vasetto, cipolla, florence, tubetto, inox o system anche laccati scala ral (vedi pag. 349).

The bed cover made of fabric is completely removable, the headboard cover made of leather or eco-leather is non removable, available with or without storage box and with box easy up.

Available with feet vasetto, cipolla, florence, tubetto, inox or system which can be lacquered in any colour ref. ral system (see page. 349)

Predisposto per materassi: l 120-140-160-170-180 x p 200

For mattresses: w 47 2/8" - 55 1/8" - 63" - 67" - 70 3/4" x d 78 3/4"

Full (double) size: predisposto per materassi l 137 x p 190 for mattresses w 54"x d 75"

Queen size: predisposto per materassi l 153 x p 203 for mattresses w 60"x d 80"

King size: predisposto per materassi l 193-198 x p 203 for mattresses w 76"x d 80"

technical details

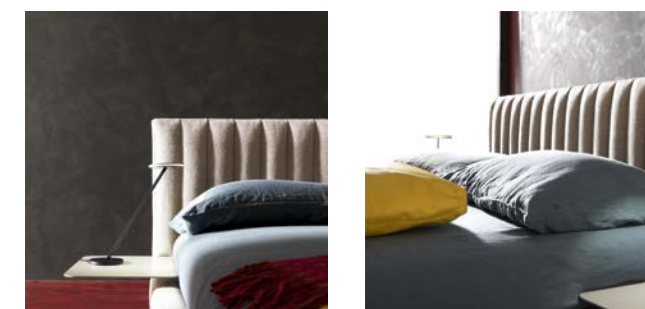
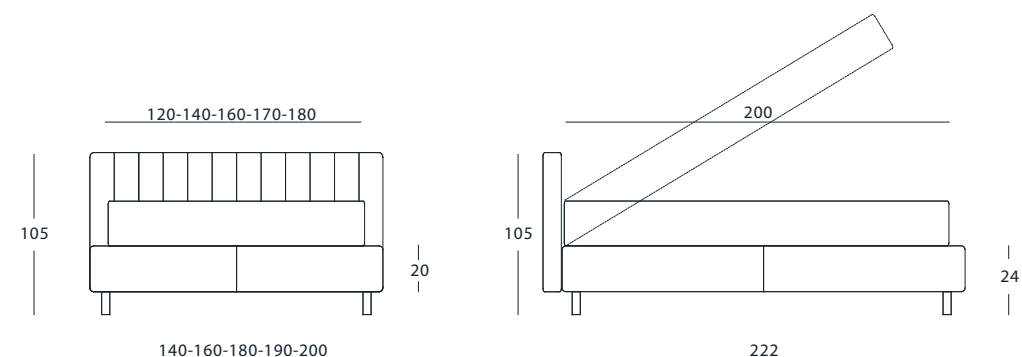

vittoria





vittoria

La linea squadrata, sottolineata dalla lavorazione a quadrati della testiera e dalla linea dei piccoli piedini in acciaio, e una sobrietà di fondo sono caratteristiche che nulla tolgono all'estetica dell'arredo. Vittoria rappresenta la scelta della razionalità sulle tendenze della moda.

The squared lines, highlighted by the square pattern of the headboard and the shape of the small steel feet, together with a sober concept, are characteristics that do not detract from the good looks of the decor. Vittoria represents a choice of rationality over fashion fads.





Letto completamente sfoderabile in tessuto e testiera non sfoderabile in pelle ed ecopelle, disponibile con basamento h 20 o h 28 con telaio in legno o in alluminio con o senza box easy up, hands free o box spring (vedi pag. 14)

Disponibile con piede vasetto, cipolla, florence, tubetto, inox o system anche laccati scala ral (vedi pag. 349)

The bed cover made of fabric is completely removable, the headboard cover made of leather or eco-leather is non removable, available with h 20 or h 28 bedbase, bedframe of solid wood or aluminium with or without storage box and with box easy up, hands free or box spring. (see page 14)

Available with feet vasetto, cipolla, florence, tubetto, inox or system which can be lacquered in any colour ref. ral system (see pag 349)

Predisposto per materassi: l 120-140-160-180 x p 200

For mattresses: w 47 2/8" – 55 1/8" – 63" – 70 3/4" x d 78 3/4"

Full (double) size: predisposto per materassi l 137 x p 190 for mattresses w 54"x d 75"

Queen size: predisposto per materassi l 153 x p 203 for mattresses w 60"x d 80"

King size: predisposto per materassi l 193-198 x p 203 for mattresses w 76"x d 80"

TECHNICAL DETAILS

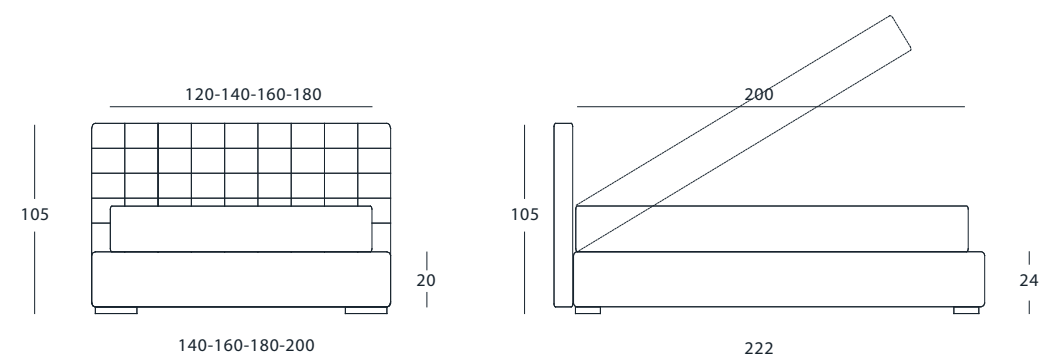

VITTORIA

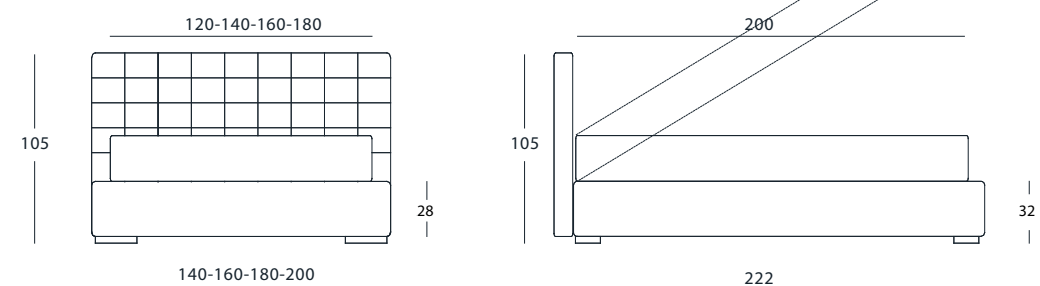

VITTORIA SUPERIOR



freedom



freedom big

Linee pulite, proporzioni armoniose, finiture di classe: il letto Freedom rende concretizzabile l'idea di raffinatezza e di semplicità.

Clear-cut lines, well-balanced dimensions and top-class finishes: Freedom bed realizes an idea of grace and simplicity.





afrodite pouf

Afrodite è bello, elegante e multiuso: facendo pressione sulla parte superiore del pouf si alza un vano segreto aperto a giorno, dove poter riporre i propri oggetti personali. Un solo elemento può fungere da seduta, da comodino e da scrigno nascosto.

Afrodite is beautiful, elegant and multi-purpose: it conceals a small drawer that can be opened with a slight push on the top to put in your personal belongings. One element that can be used as seat, as night table and chest.

sightly paravento
circus capitonè pouf

Il pouf circus capitonè e il paravento sightly ben si abbinano avendo in comune uno charme e un'eleganza ineguagliabile. La stanza che li ospita si appropria delle loro caratteristiche con una classe unica,

Circus capitonné pouf and Sightly screen can be well combined, having in common a charm and an incomparable elegance. The room in which they are, takes its characteristics with a unique style.





freedom





technical details

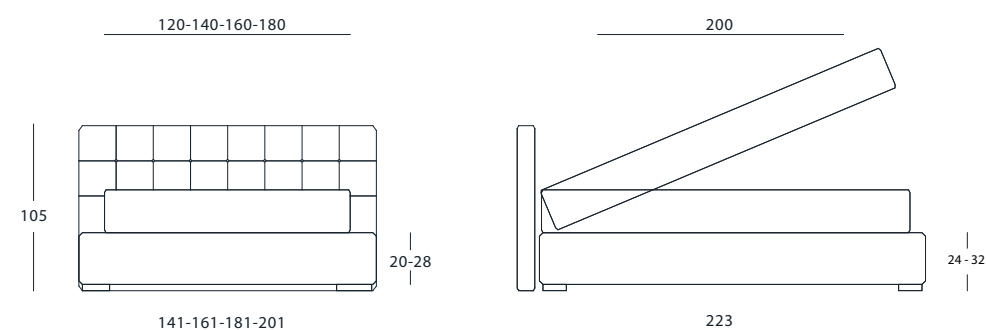

FREEDOM

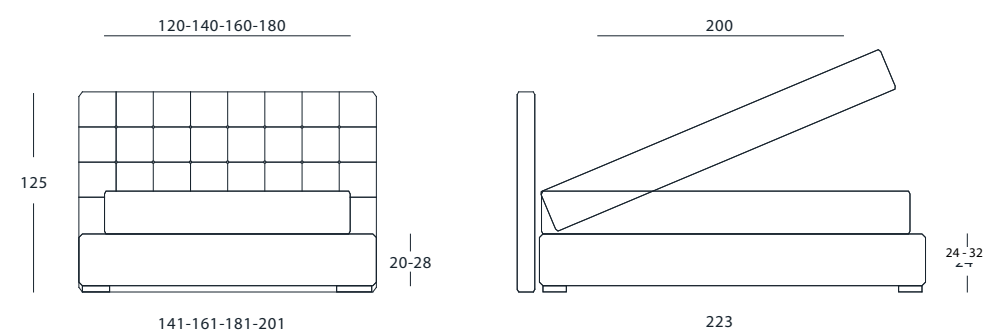

FREEDOM MEDIUM

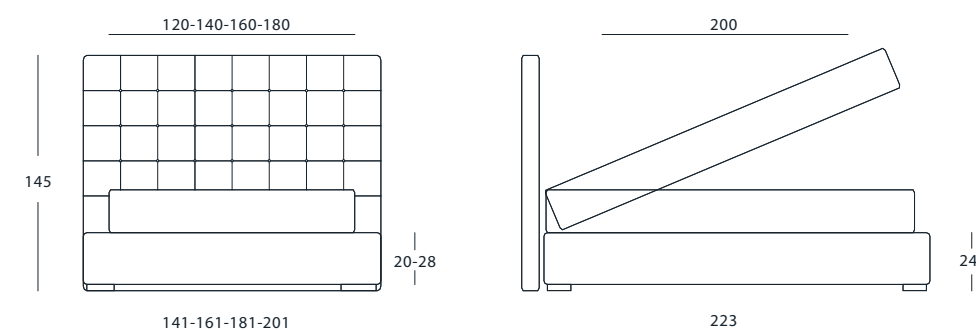

FREEDOM BIG

Testiera non sfoderabile, disponibile con basamento h.20 o h.28 con telaio in legno o in alluminio con o senza box e c/box easy up, hands free o box spring. (vedi pag. 14).

Disponibile con o senza bottoni, e con testiera h. 105, 125 o 145 cm..

Disponibile con piede vasetto, cipolla, florence, tubetto, inox o system anche laccati scala ral (vedi pag. 349)

The headboard cover is non removable, available h.20 or h.28 cm bedbase, bedframe of solid wood or aluminum with or without storage box and with box easy up, hands free or box spring (see page 14).

Available with or without buttons, and headboard h. 105, 125 o 145 cm..

Available with feet vasetto, cipolla, florence, tubetto, inox or system which can be lacquered in any colour ref. ral system (see page 349)

Predisposto per materassi: l 100-120-140-160-180 x p 200

For mattresses: w 39 3/8" – 47 2/8" 55 1/8" – 63" – 70 3/4" x d 78 3/4"

Full (double) size: predisposto per materassi l 137 x p 190 for mattresses w 54"x d 75"

Queen size: predisposto per materassi l 153 x p 203 for mattresses w 60"x d 80"

King size: predisposto per materassi l 193-198 x p 203 for mattresses w 76"x d 80"

con bottoni



senza bottoni



exige





exige

Exige rappresenta l'amore per le linee classiche ed è caratterizzato da particolari che lo rendono unico: grande testiera imbottita e impreziosita dall'inserimento di elementi decorativi e i piedini lavorati che richiamano atmosfere decisamente retrò.

Exige represents the love for classic lines and features details that make it unique. The large upholstered headboard is enhanced by the inclusion of decorative elements while the feet recall a retrò atmosphere.

exige



Testiera non sfoderabile, disponibile con o senza box e c/box easy up.

Disponibile con piede vasetto, cipolla, florence, tubetto, inox o system anche laccati scala ral (vedi pag. 349)

The headboard cover is non removable, available with or without storage box and with box easy up.

Available with feet vasetto, cipolla, florence, tubetto, inox or system which can be lacquered in any colour ref. ral system (see pag. 349)

Predisposto per materassi: l 170-160-180 x p 200

For mattresses: w 63" – 67" – 70 ¾" x d 78 ¾"

Queen size: predisposto per materassi l 153 x p 203 for mattresses w 60"x d 80"

King size: predisposto per materassi l 193-198 x p 203 for mattresses w 76"x d 80"

technical details

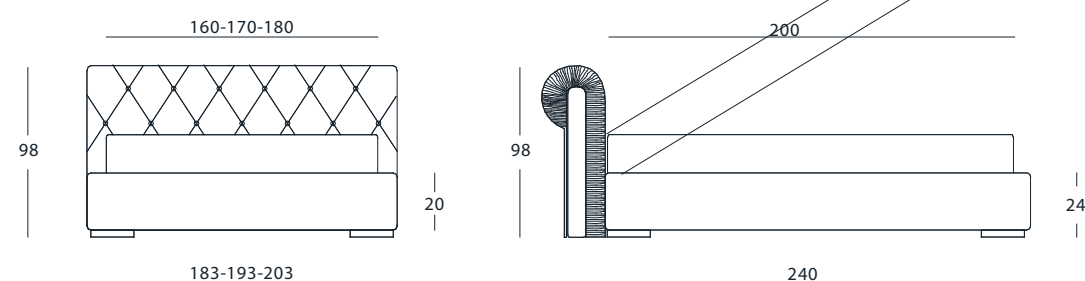

selene





selene box



selene h. 9

Selene è un ritorno al passato rivisitato in un'ottica di simpatica spregiudicatezza per donare un pò di allegria e glamour alla vita quotidiana e alle forme più semplici.

Selene represents a return to the past revisited with an open mind in order to make daily life more joyful and glamorous and to re-light simple shapes.



selene large





300



301



teorema tavolino

La linea orizzontale rigorosa di Selene Large viene prepotentemente spezzata dalla forte verticalità dell'ampia testiera con lavorazione capitonné. Non serve altro per creare una zona notte protetta e intima.

In questo gioco di linearità spezzate entra di diritto il Tavolino Teorema, dalle forme rigide e pungenti, capace di distinguersi per la sua modularità versatile e fuori dagli schemi.

The rigorous horizontal line of Selene Large is broken up by the vertical importance of this wide quilted headboard. Nothing more is necessary to create a cozy and intimate sleeping area. Teorema table with its sharp and rigorous shape represents the ideal complement in this game of lines. You will appreciate its extraordinary modularity.



selene extra large

Selene extra Large è caratterizzato da una testiera ancora più avvolgente. Squadrato nei volumi, acquista leggerezza e slancio grazie ai piedini circolari che rimandano alla sinuosità della lavorazione capitonné e alle forme armoniche del comodino Venice che lo accompagna.

Selene extra Large features an extra-wide headboard. The squared shapes gain lightness thanks to the round feet that recall the sinuous quilting on the headboard and the graceful shape of Venice night table.



technical details

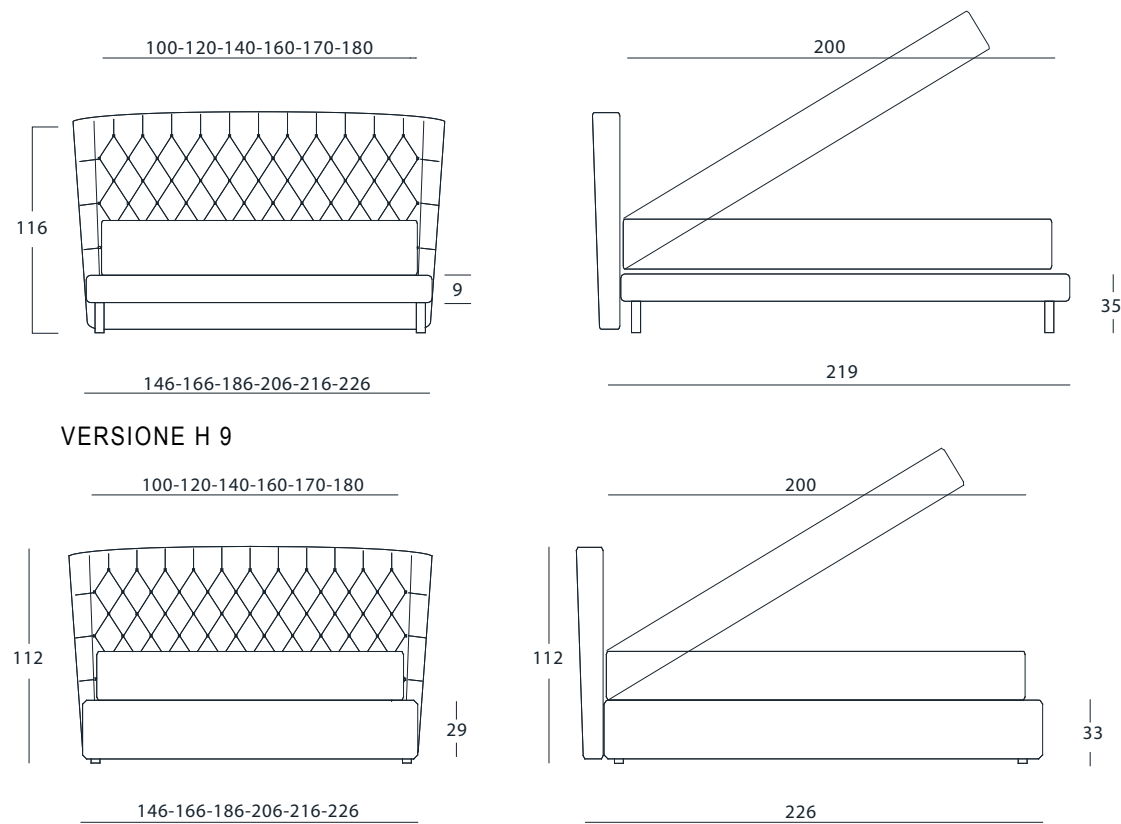

VERSIONE BOX

Testiera non sfoderabile, disponibile con basamento sottile o sagomato h.29 con telaio in legno o in alluminio con o senza box e c/box easy up, hands free o box spring. (vedi pag. 14).

Basamento sottile disponibile con piede vasetto, vasetto inclinato, inox, plaza, bridge, slitt, linea, gold e dorian. Piedi in legno disponibili anche laccati scala ral o rivestiti in tessuto o pelle (vedi pag. 348).

Basamento sagomato h.29 disponibile con piede vasetto, cipolla, florence, tubetto, inox o system anche laccati scala ral (vedi pag. 349)

The headboard cover is non removable, available with bedbase h.29 cm rounded bedbase, bedframe of solid wood or aluminum with or without storage box and with box easy up, hands free or box spring (see page 14).

Thin bedbase available with the following feet: vasetto, vasetto inclinati, inox, plaza, bridge, slitt, linea, gold and dorian. Wood feet available also lacquered in a color of the ral system or covered in fabric or leather (see page 348).

Rounded bedbase h.29 available with the following feet: vasetto, cipolla, florence, tubetto, inox or system also lacquered in a color of the ral system (see page 349)

Predisposto per materassi: l 100-120-140-160-170-180 x p 200

For mattresses: w 39 3/8" – 47 2/8" – 55 1/8" – 63" – 67" – 70 3/4" x d 78 3/4"

Full (double) size: predisposto per materassi l 137 x p 190 for mattresses w 54"x d 75"

Queen size: predisposto per materassi l 153 x p 203 for mattresses w 60"x d 80"

King size: predisposto per materassi l 193-198 x p 203 for mattresses w 76"x d 80"

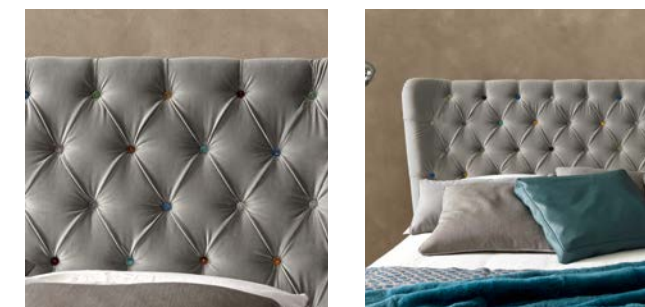



Testiera non sfoderabile, disponibile con telaio in legno o in alluminio con o senza box e c/box easy up, hands free o box spring. (vedi pag. 14).

Disponibile con piede vasetto, cipolla, florence, tubetto, inox o system anche laccati scala ral (vedi pag. 349)

The headboard cover is non removable, available with bedframe of solid wood or aluminum with or without storage box and with box easy up, hands free or box spring (see page 14).

Available with feet vasetto, cipolla, florence, tubetto, inox or system which can be lacquered in any colour ref. ral system (see pag. 349)

Predisposto per materassi: l 100-120-140-160-170-180 x p 200

For mattresses: w 39 3/8" – 47 2/8" – 55 1/8" – 63" – 67" – 70 3/4" x d 78 3/4"

Full (double) size: predisposto per materassi l 137 x p 190 for mattresses w 54"x d 75"

Queen size: predisposto per materassi l 153 x p 203 for mattresses w 60"x d 80"

King size: predisposto per materassi l 193-198 x p 203 for mattresses w 76"x d 80"

technical details

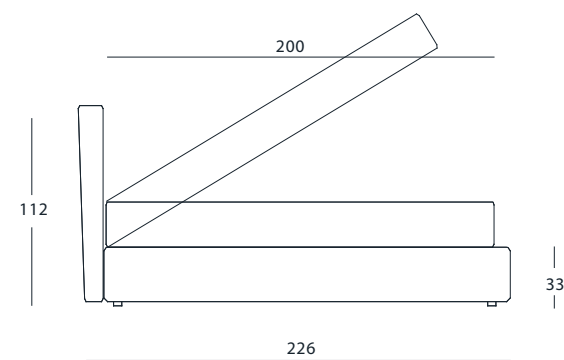
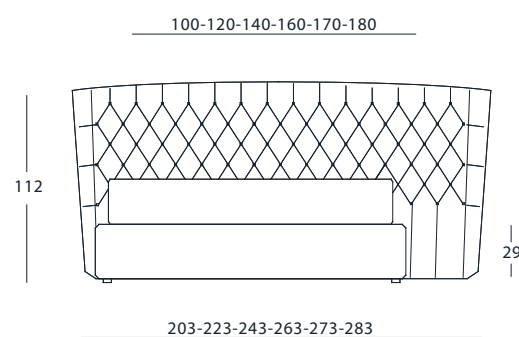



Testiera non sfoderabile, disponibile con telaio in legno o in alluminio con o senza box e c/box easy up, hands free o box spring. (vedi pag. 14).

Disponibile con piede vasetto, cipolla, florence, tubetto, inox o system anche laccati scala ral (vedi pag. 349)

The headboard cover is non removable, available with bedframe of solid wood or aluminum with or without storage box and with box easy up, hands free or box spring (see page 14).

Available with feet vasetto, cipolla, florence, tubetto, inox or system which can be lacquered in any colour ref. ral scale (see pag 349)

Predisposto per materassi: l 100-120-140-160-170-180 x p 200

For mattresses: w 39 3/8" – 47 2/8" – 55 1/8" – 63" – 67" – 70 3/4" x d 78 3/4"

Full (double) size: predisposto per materassi l 137 x p 190 for mattresses w 54"x d 75"

Queen size: predisposto per materassi l 153 x p 203 for mattresses w 60"x d 80"

King size: predisposto per materassi l 193-198 x p 203 for mattresses w 76"x d 80"

technical details

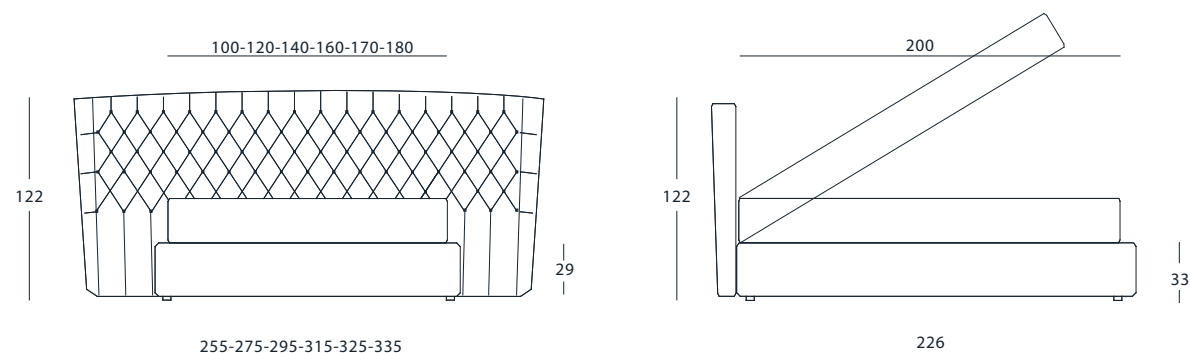

ceylon





314

ceylon

Fatto di legno e imbottito con stile, Ceylon è il letto della nobiltà odierna. Un letto che ti abbraccia fra le sue mura e diventa la casa dei sogni.

Made of wood and upholstered with elegance, Ceylon is the bed of today's royalty. A bed that within its walls embraces you and becomes the home of dreams.



trapuntato pouf

315

INDEX







Testiera completamente sfoderabile.

Disponibile nelle finiture: rovere, wengè e laccato scala ral lucido o opaco.
Disponibile con o senza veli.
(colore bianco o beige o con tessuto Voilà)

The headboard cover is completely removable.

Available in the following finishings: oak, wengè, lacquered in any colour ref. ral system matt or shiny.
Available with or without drapes
(colors white or beige or in Voil  fabric)

Predisposto per materassi: l 160 x p 200

For mattresses: w 63" x d 78 3/4"

technical details

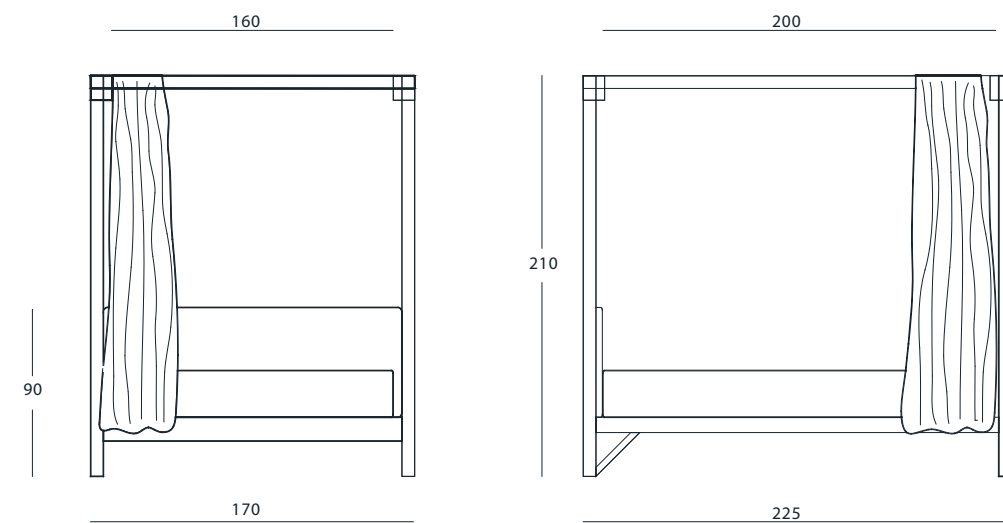





324



325



pandora pouf

INDEX

freedom contract





328

329

INDEX

freedom contract

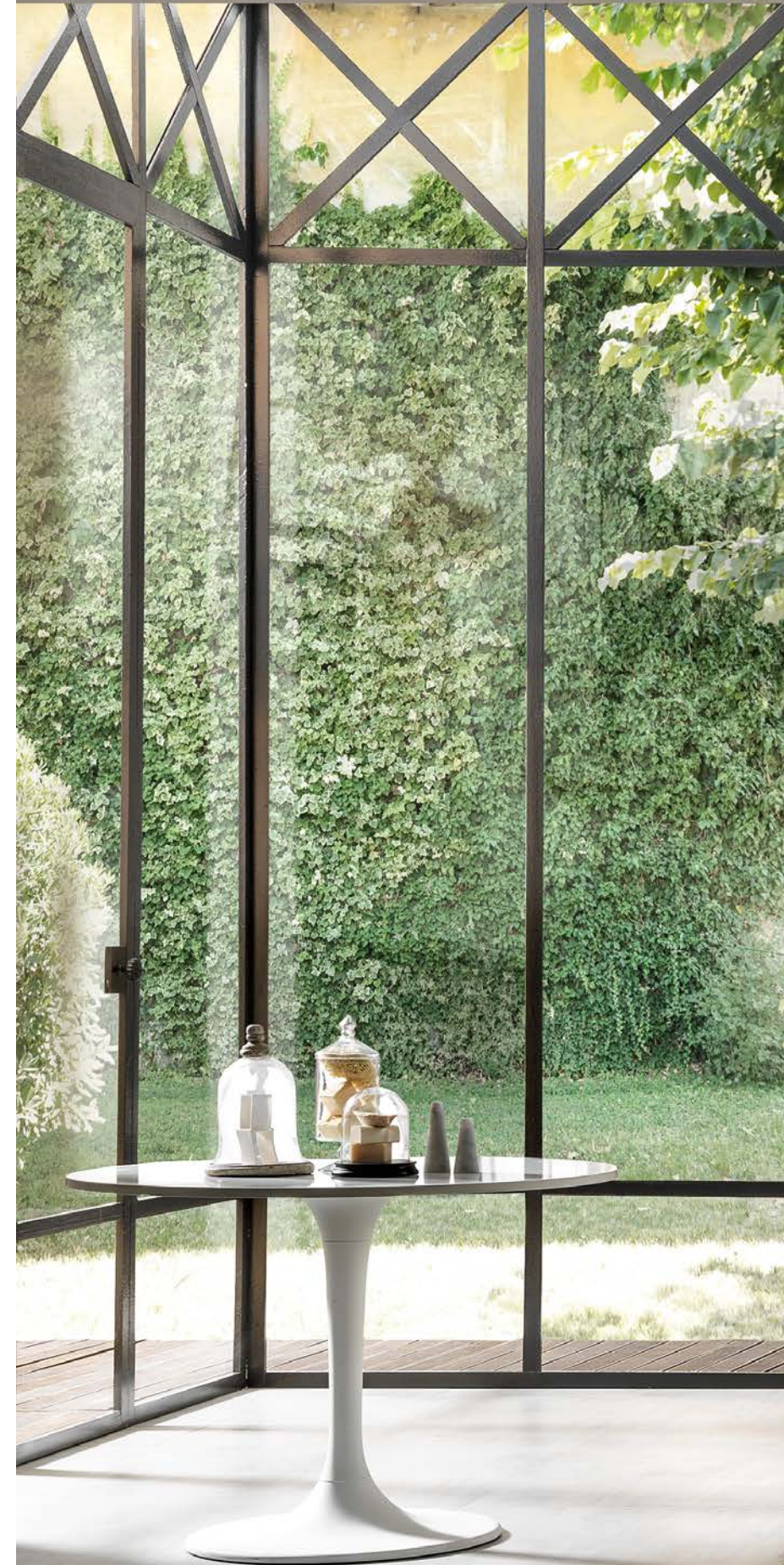



freedom contract

Un mondo notturno sempre più avvolgente: freedom Contract è il letto tessile caratterizzato dall'ampia superficie del pannello imbottito della testiera. Una proposta all'insegna della massima originalità ed eleganza.

A more and more "embracing" sleeping area: freedom contract is the upholstered bed characterized by its huge padded headboard: an original and elegant proposal.

freedom contract

Testiera a progetto non sfoderabile predisposta con fissaggio a muro, disponibile con o senza bottoni.

Sommier sfoderabile in tessuto e non sfoderabile in pelle ed ecopelle, disponibile nella versione Executive A, A plus, B, B plus, C e C Plus (vedi pag 017).

Tailor-made headboard with non-removable cover, to be fixed to the wall, available with or without buttons.

Sommier with removable cover in fabric and non removable cover in leather or eco-leather, available in the Executive version, A, A plus, B, B plus, C and C Plus (see pages 017).

La versione in foto testiera s/bottoni con sommier matrimoniale (162x202) misure ingombro testiera 281xh.121

Version in the photo: headboard without buttons with double bed sommier (162x202), headboard external dimensions 281xh.121



La versione in foto testiera s/bottoni con sommier matrimoniale (162x202) misure ingombro testiera 400xh.200

Version in the photo: headboard without buttons with double bed sommier (162x202), headboard external dimensions 400xh.200



La versione in foto testiera c/bottoni con sommier matrimoniale (162x202) misure ingombro testiera 400xh.200

Version in the photo: headboard with buttons with double bed sommier (162x202), headboard external dimensions 400xh.200



dubai contract







selene contract





dubai contract

Testiera a progetto non sfoderabile, predisposta con fissaggio a muro.

Sommier sfoderabile in tessuto e non sfoderabile in pelle ed ecopelle, disponibile nella versione Exeuctive A, A plus, B, B plus, C e c Plus (vedi pag 017).

Tailor-made headboard with non-removable cover to be fixed to the wall.

Sommier with removable cover in fabric and non removable cover in leather or eco-leather, available in the Executive version, A, A plus, B, B plus, C and C Plus (see pages 017).

La versione in foto con 1 sommier matrimoniale (162x202) e 1 sommier singolo (82x202) misure ingombro testiera 298xh.190 e 105xh.190

Version in the photo: with 1 double-bed sommier (162x202), external headboard dimensions 298xh.190 and 105xh.190



selene contract

Testiera a progetto non sfoderabile, predisposta con fissaggio a muro.

Sommier sfoderabile in tessuto e non sfoderabile in pelle ed ecopelle, disponibile nella versione Exeuctive A, A plus, B, B plus, C e c Plus (vedi pag 017).

Tailor-made headboard with non-removable cover, to be fixed to the wall.

Sommier with removable cover in fabric and non removable cover in leather or eco-leather, available in the Executive version, A, A plus, B, B plus, C and C Plus (see pages 017).

La versione in foto con 2 sommier singoli (82x202) misure ingombro testiera 355XH.119

Version in the photo: with 2 single-bed sommier (82x202), external headboard dimensions 355xh.119

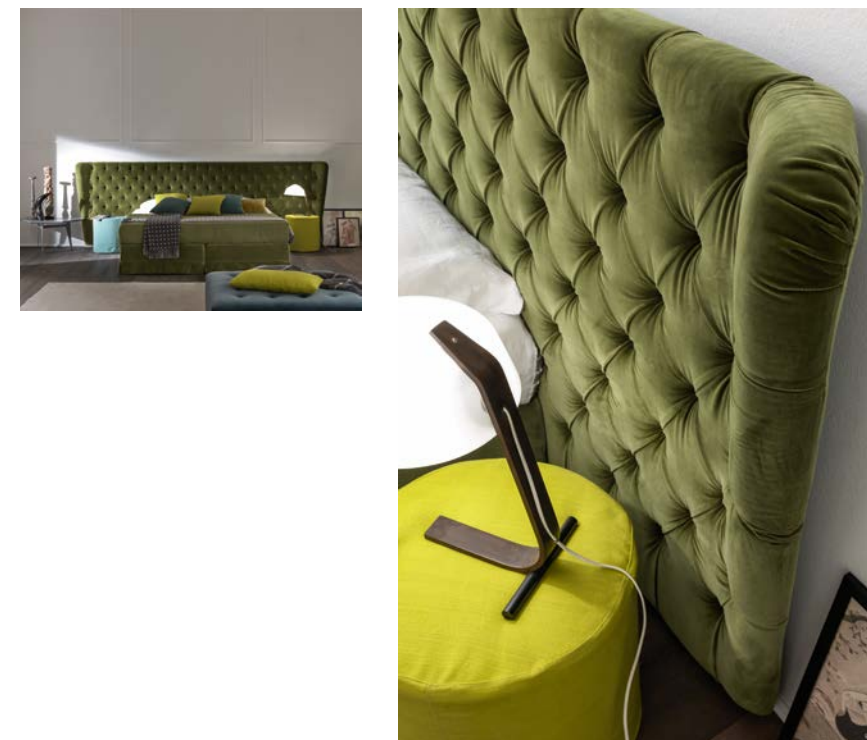



PLAZA H. 26

finiture : ciliegio
noce
rovere
wengè
laccati ral
rivestimento tessuto

finishings : cherry
walnut
oak
wengè
ral lacquered
covered with fabric



BRIDGE H. 26

finiture : corten

finishings : corten



SLITTA H. 26

finiture : cromo nero

finishings : black chrome



DORIAN H. 26

finiture : noce canaletto
frassino naturale

finishings : noce canaletto
natural ash



INOX H. 22

finiture : inox lucido

finishings : shiny inox



LINEA H. 26

finiture : bronzo

finishings : bronze



GOLD H. 26

finiture : oro
oro rosa
nero grafite

finishings : gold
pink gold
black graphite



VASETTO H. 26

finiture : ciliegio
noce
rovere
wengè
laccati ral
rivestimento tessuto

finishings : cherry
walnut
oak
wengè
ral lacquered
covered with fabric



VASETTO INCLINATO H. 26

finiture : ciliegio
noce
rovere
wengè
laccati ral
rivestimento tessuto

finishings : cherry
walnut
oak
wengè
ral lacquered
covered with fabric



RUOTA H. 12.5

finiture : nero

finishings : black



VASETTO H. 9 H. 12.5

finiture : ciliegio
noce
rovere
wengè
laccati ral
rivestimento tessuto

finishings : cherry
walnut
oak
wengè
ral lacquered
covered with fabric



SYSTEM H. 4.5

finiture : inox
ciliegio
noce
rovere
wengè
laccati ral

finishings : inox
cherry
walnut
oak
wengè
ral lacquered



TUBETTO H. 12.5

finiture : inox satinato

finishings : satinized inox



VASETTO H. 4

finiture : ciliegio
noce
rovere
wengè
laccati ral

finishings : cherry
walnut
oak
wengè
ral lacquered



INOX H. 12.5

finiture : inox lucido

finishings : shiny inox



CIPOLLA H. 8

finiture : ciliegio
noce
rovere
wengè
laccati ral

finishings : cherry
walnut
oak
wengè
ral lacquered



FLORENCE H. 12.5

finiture : ciliegio
noce
rovere
wengè
laccati ral

finishings : cherry
walnut
oak
wengè
ral lacquered

COMPLEMENTI

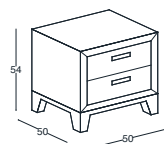

comodino JUBILÈ

Comodino non sfoderabile.
Maniglie e zoccolo laccato opaco scala Ral. Possibilità di inserire top in marmo nelle finiture calacatta, emperador dark e fior di pesco.



Non removable bedside table cover.
Handle and socle lacquered in matt colour specify Ral system NR. Available with marble top in the following colors: calacatta, emperador dark and fior di pesco



Dim. l 50 p 50 h 54
Dim. w 19 11/16" d 19 11/16" h 21 2/8"

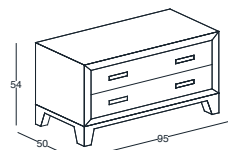

comò JUBILÈ 2 cassetti

Comò non sfoderabile.
Maniglie e zoccolo laccato opaco scala Ral. Possibilità di inserire top in marmo nelle finiture calacatta, emperador dark e fior di pesco.



Non removable chest of drawers cover.
Handle and socle lacquered in matt colour specify Ral system NR. Available with marble top in the following colors: calacatta, emperador dark and fior di pesco.



Dim. l 95 p 50 h 54
Dim. w 37 6/16" d 19 11/16" h. 21 1/4"

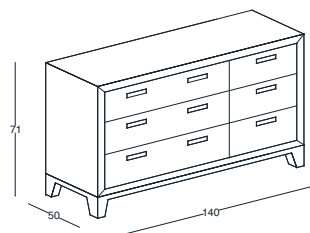

comò JUBILÈ 3 + 3 cassetti piccoli

Comò non sfoderabile.
Maniglie e zoccolo laccato opaco scala Ral. Possibilità di inserire top in marmo nelle finiture calacatta, emperador dark e fior di pesco.



Non removable chest of drawers cover.
Handle and socle lacquered in matt colour specify Ral system NR. Available with marble top in the following colors: calacatta, emperador dark and fior di pesco



Dim. l 140 p 50 h 71
Dim. w 55 3/16" d 19 11/16" h 28

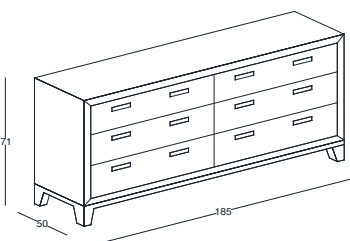

comò JUBILÈ 3 + 3 cassetti

Comò non sfoderabile.
Maniglie e zoccolo laccato opaco scala Ral. Possibilità di inserire top in marmo nelle finiture calacatta, emperador dark e fior di pesco.



Non removable chest of drawers cover.
Handle and socle lacquered in matt colour specify Ral system NR. Available with marble top in the following colors: calacatta, emperador dark and fior di pesco.



Dim. l 185 p 50 h 71
Dim. w 72 7/8" d 19 11/16" h 28

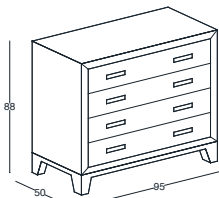

comò JUBILÈ 4 cassetti

Comò non sfoderabile, realizzabile unicamente in tessuto.
Maniglie e zoccolo laccato opaco scala Ral. Possibilità di inserire top in marmo nelle finiture calacatta, emperador dark e fior di pesco.



Non removable chest of drawers cover, available only in fabric.
Handle and socle lacquered in matt colour specify Ral system NR. Available with marble top in the following colors: calacatta, emperador dark and fior di pesco



Dim. l 95 p 50 h.88
Dim w 37 6/16" d 19 11/16" h. 34 5/8"

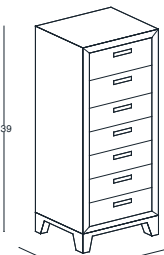

settimino JUBILÈ

Settimino non sfoderabile, realizzabile unicamente in tessuto.
Maniglie e zoccolo laccato opaco scala Ral. Possibilità di inserire top in marmo nelle finiture calacatta, emperador dark e fior di pesco.



Non removable seven drawers cover, available only in fabric.
Handle and socle lacquered in matt colour specify Ral system NR. Available with marble top in the following colors: calacatta, emperador dark and fior di pesco.



Dim. l 50 p 50 h 139
Dim. w 19 11/16" d 19 11/16" h 54 3/4

COMPLEMENTI

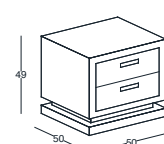

COMODINO OYSTER

pag. 104

Comodino non sfoderabile.
Maniglie e zoccolo laccato opaco scala Ral.



Possibilità di inserire top in marmo nelle finiture calacatta, emperador dark e fior di pesco.

Non removable bedside table cover.
Handle and socle lacquered in matt colour specify Ral system NR. Available with marble top in the following colors: calacatta, emperador dark and fior di pesco



Dim. l 50 p 50 h 49
Dim. w 19 11/16" d 19 11/16" h. 19 5/16"

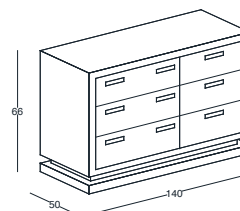

COMO' OYSTER 3+3 cassetti piccoli

pag. 105.126.127.143

Comò non sfoderabile.
Maniglie e zoccolo laccato opaco scala Ral.



Possibilità di inserire top in marmo nelle finiture calacatta, emperador dark e fior di pesco.

Non removable chest of drawers cover.
Handle and socle lacquered in matt colour specify Ral system NR. Available with marble top in the following colors: calacatta, emperador dark and fior di pesco



Dim. l 140 p 50 h 66
Dim. w 55 3/16" d 19 11/16" h. 26"

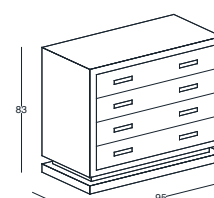

COMO' OYSTER 4 cassetti

Comò non sfoderabile, realizzabile unicamente in tessuto.
Maniglie e zoccolo laccato opaco scala Ral. Possibilità di inserire top in marmo nelle finiture calacatta, emperador dark e fior di pesco.



Non removable chest of drawers cover, available only in fabric.
Handle and socle lacquered in matt colour specify Ral system NR. Available with marble top in the following colors: calacatta, emperador dark and fior di pesco



Dim. l 95 p 50 h 83
Dim. w 37 6/16" d 19 11/16" h. 32 11/16"

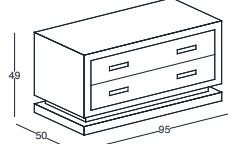

COMO' OYSTER 2 cassetti

pag. 036

Comò non sfoderabile.
Maniglie e zoccolo laccato opaco scala Ral.



Possibilità di inserire top in marmo nelle finiture calacatta, emperador dark e fior di pesco.

Non removable chest of drawers cover.
Handle and socle lacquered in matt colour specify Ral system NR. Available with marble top in the following colors: calacatta, emperador dark and fior di pesco



Dim. l 95 p 50 h 49
Dim. w 37 6/16" d 19 11/16" h. 19 5/16"

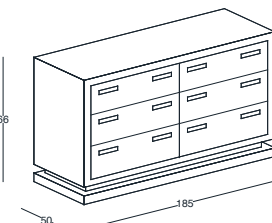

COMO' OYSTER 3+3 cassetti

Comò non sfoderabile.
Maniglie e zoccolo laccato opaco scala Ral.



Possibilità di inserire top in marmo nelle finiture calacatta, emperador dark e fior di pesco.

Non removable chest of drawers cover.
Handle and socle lacquered in matt colour specify Ral system NR. Available with marble top in the following colors: calacatta, emperador dark and fior di pesco



Dim. l 185 p 50 h 66
Dim. w 72 7/8" d 19 11/16" h. 26"



SETTIMINO OYSTER

Settimino non sfoderabile, realizzabile unicamente in tessuto.
Maniglie e zoccolo laccato opaco scala Ral.



Possibilità di inserire top in marmo nelle finiture calacatta, emperador dark e fior di pesco.

Non removable seven drawers cover, available only in fabric.
Handle and socle lacquered in matt colour specify Ral system NR. Available with marble top in the following colors: calacatta, emperador dark and fior di pesco



Dim. l 50 p 50 h 134
Dim. w 19 11/16" d 19 11/16" h.52 3/4"

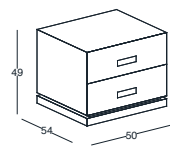

pag. 100

COMODINO DAYTONA

Comodino non sfoderabile.
Maniglie e zoccolo laccato opaco scala Ral.



Non removable bedside table cover.
Handle and socle lacquered in matt colour specify Ral system NR.



Dim. l 50 p 54 h 49
Dim. w 19 11/16" d 21 1/4" h. 19 5/16"

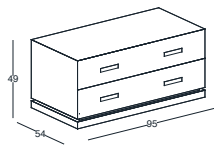

COMO' DAYTONA 2 cassetti

Comò non sfoderabile.
Maniglie e zoccolo laccato opaco scala Ral.



Non removable chest of drawers cover.
Handle and socle lacquered in matt colour specify Ral system NR.



Dim. l 95 p 54 h 49
Dim. w 37 6/16" d 21 1/4" h. 19 5/16"

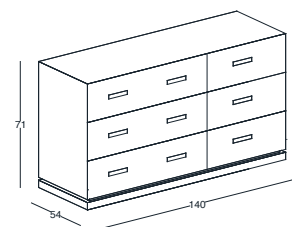

COMO' DAYTONA 3+3 cassetti piccoli

Comò non sfoderabile.
Maniglie e zoccolo laccato opaco scala Ral.



Non removable chest of drawers cover.
Handle and socle lacquered in matt colour specify Ral system NR.



Dim. l 140 p 54 h 71
Dim. w 55 3/16" d 21 1/4" h. 27 15/16"

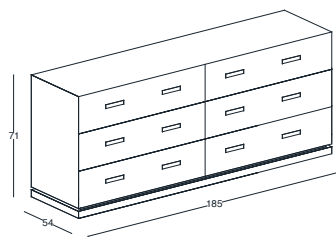

COMO' DAYTONA 3+3 cassetti

Comò non sfoderabile.
Maniglie e zoccolo laccato opaco scala Ral.



Non removable chest of drawers cover.
Handle and socle lacquered in matt colour specify Ral system NR.



Dim. l 185 p 54 h 71
Dim. w 72 7/8" d 21 1/4" h. 27 15/16"

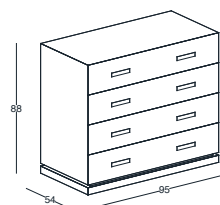

COMO' DAYTONA 4 cassetti

Comò non sfoderabile, realizzabile unicamente in tessuto.
Maniglie e zoccolo laccato opaco scala Ral.



Non removable chest of drawers cover, available only in fabric.
Handle and socle lacquered in matt colour specify Ral system NR.



Dim. l 95 p 54 h 88
Dim. w 37 6/16" d 21 1/4" h. 34 5/12"



SETTIMINO DAYTONA

Settimino non sfoderabile, realizzabile unicamente in tessuto.
Maniglie e zoccolo laccato opaco scala Ral.



Non removable seven drawers cover, available only in fabric.
Handle and socle lacquered in matt colour specify Ral system NR.



Dim. l 50 p 54 h 134
Dim. w 19 11/16" d 21 1/4" h. 52 3/4"

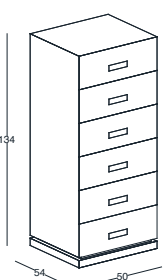

pag. 099



pouf CIRCUS CAPITONE'

Pouf non sfoderabile.

The pouf cover is non removable.

Dim. Ø 100 h. 45
Dim. Ø 39 3/8" h. 17 11/16"

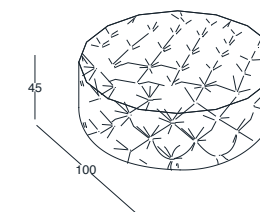

pag. 078.079.277.296.324



pouf CIRCUS COROLLE

Pouf completamente sfoderabile, realizzabile unicamente in tessuto.

The pouf cover is completely removable, available only in fabric.

Dim. Ø 113 h. 39
Dim. Ø 44 1/2" h. 15 3/8"

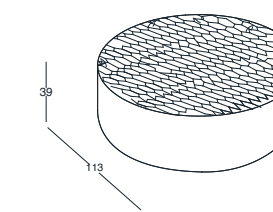

pag. 029



pouf QUADRATO COROLLE

Pouf completamente sfoderabile, realizzabile unicamente in tessuto.

The pouf cover is completely removable, available only in fabric.

Dim. l 46 p 46 h 46
Dim. w 18 1/8" d 18 1/8 h. 18 1/8"

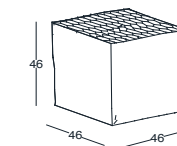

pouf TONDO COROLLE

Pouf completamente sfoderabile, realizzabile unicamente in tessuto.

The pouf cover is completely removable, available only in fabric.

Dim. Ø 47 h. 46
Dim. Ø 18 1/2" h. 18 1/8"

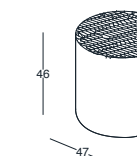

pag. 029



panchetta COROLLE

Panchetta completamente sfoderabile, realizzabile unicamente in tessuto.

The bench cover is completely removable, available only in fabric.

Dim. l 122x p 46xh. 48
Dim. w 48" d 18 1/8" h. 18 14/16"

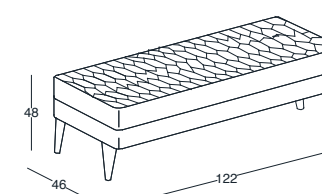

pag. 029.138



pouf ARES

Pouf con cassetto a scomparsa, non sfoderabile. Disponibile con top nel rivestimento scelto, con vetro argentato o laccato colori scala ral. Disponibile con dock station.



Pouf with push-down drawer, not removable cover. Available with top in same cover of pouf in silver glass or lacquered in any colour of ral system. Available with dock station.



Dim. l 45 p 45 h 46
Dim. w 17 11/16" d 17 11/16" x h 18 1/8"

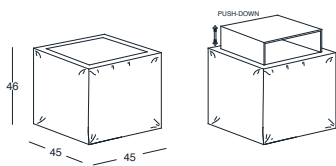

pag. 144.145.198

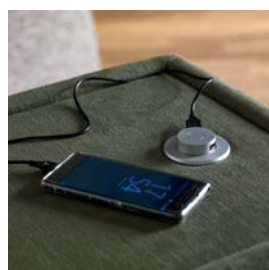

DOCK STATION

Kit audio Bluetooth con doppia presa USB per ricaricare i propri smartphone e altri devices. Il kit è caratterizzato dalla dock station pop-up e dalle casse rettangolari con subwoofer incorporato.

Bluetooth audio kit with dual USB socket to recharge your smartphone and other devices. The kit is characterized by the pop-up dock station and the subwoofer incorporated into the speakers.

Specifiche/Specifications:
-lettore audio Bluetooth / Bluetooth audio player
-2 porte USB per ricaricare / 2 USB ports to recharge
-Tasti soft touch / soft touch buttons
-4Ω 10W speaker power

pag. 198



pouf AFRODITE

Pouf con cassetto a scomparsa, non sfoderabile. Disponibile con top nel rivestimento scelto, con vetro argentato o laccato colori scala ral. Disponibile con dock station.



Pouf with push-down drawer, not removable cover. Available with top in same cover of pouf in silver glass or lacquered in any colour of ral system. Available with dock station.



Dim. l 55 p 55 h 46
Dim. w 21 5/8" d 21 5/8" h 18 1/8"

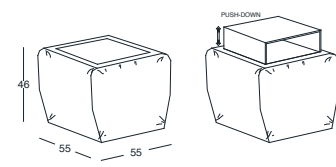

pag. 274.275



pouf ATENA

Pouf con cassetto a scomparsa, non sfoderabile. Disponibile con top nel rivestimento scelto, con vetro argentato o laccato colori scala ral. Disponibile con dock station.



Pouf with push-down drawer, not removable cover. Available with top in same cover of pouf in silver glass or lacquered in any colour of ral system. Available with dock station.



Dim. l 49 p 49 x h 46
Dim. w 19 5/16 d 19 5/16 h 18 1/8"

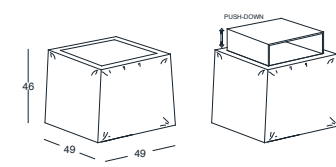

pag. 114.115



pouf ESTIA

Pouf con cassetto a scomparsa, non sfoderabile. Disponibile con top nel rivestimento scelto, con vetro argentato o laccato colori scala ral. Disponibile con dock station.



Pouf with push-down drawer, not removable cover. Available with top in same cover of pouf in silver glass or lacquered in any colour of ral system. Available with dock station.



Dim. l 56 p 56 h 46
Dim. w 22" d 22" h 18 1/8"

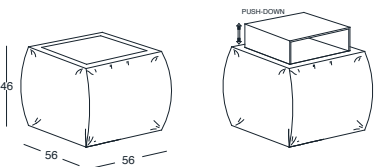

pag. 253



pouf DINGHY

Pouf sfoderabile in tessuto e non sfoderabile in pelle ed ecopelle.

Pouf with removable cover in fabric, non-removable in leather or eco-leather.

Disponibile in 2 misure l 58 p 58 h 38 o l 104 p 58 h 38
Available in 2 sizes w 22 13/16" d 22 13/16" h 14 15/16" or w 40 15/16" d 22 13/16" h 14 15/16"

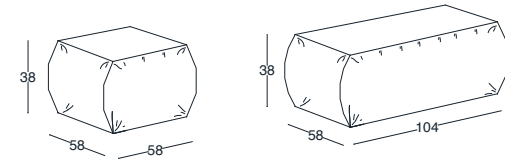

pag. 169



pouf QUADRATO

Pouf sfoderabile in tessuto e non sfoderabile in pelle ed ecopelle.

Pouf with removable cover in fabric, non-removable in leather or eco-leather.

Dim. l 45 p 45x h 46
Dim. w 17 11/16" d 17 11/16" x h 18 1/8"

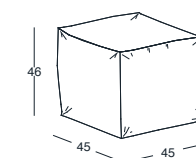

pouf HAWAII

Pouf sfoderabile in tessuto e non sfoderabile in pelle ed ecopelle.

Pouf with removable cover in fabric, non-removable in leather or eco-leather.

Dim. l 100 p 100 h 42
Dim. w 39 3/8" d 39 3/8" h 16 10/16"

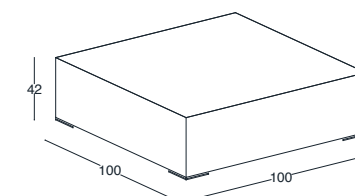

pouf CIRCUS

Pouf sfoderabile in tessuto e non sfoderabile in pelle ed ecopelle.

Pouf with removable cover in fabric, non-removable in leather or eco-leather.

Dim. Ø 110 / 85 h 42
Dim. Ø 43 5/16" Ø 33 7/16" h 16 10/16"

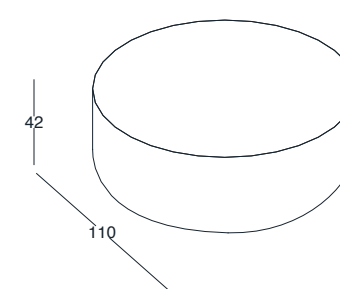

pag. 058



pouf TONDO

Pouf sfoderabile in tessuto e non sfoderabile in pelle ed ecopelle.

Pouf with removable cover in fabric, non-removable in leather or eco-leather.

Dim. Ø 45 h 46
Dim. Ø 17 11/16" h 18 1/8"

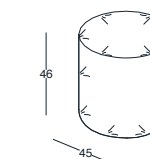

pag. 146



pouf TRAPUNTATO

Pouf non sfoderabile.

Pouf with non removable cover.

Dim. l 100 p 100 h 42
Dim. w 39 3/8" d 39 3/8" h 16 10/16"

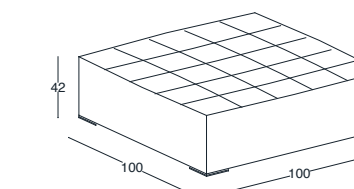

pag. 315



pouf LISTEREN

Pouf non sfoderabile. Realizzabile in ecopelle, pelle ed alcantara.

Pouf with non removable cover. Available exclusively in eco-leather, leather and alcantara.

Dim. l 93 p 52 h 34
Dim. w 36 5/8" d 20 1/2" h 13 3/8"

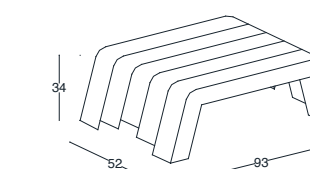

pag. 241



pouf CUBE

Pouf c/interno in polistirolo, sfoderabile in tessuto e non sfoderabile in pelle ed ecopelle.

Pouf filled with polystyrene, removable cover in fabric, non-removable in leather or eco-leather.

Dim. l 48 p 48 h 46~
Dim. w 18 7/8" d 18 7/8" h 18 1/8"~

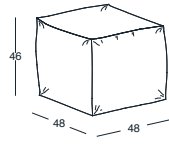

pag. 215



pouf CUBE LARGE

Pouf con interno in polistirolo, sfoderabile in tessuto e non sfoderabile in pelle ed ecopelle.

Pouf filled with polystyrene, removable cover in fabric, non-removable in leather or eco-leather.

Dim. l 70 p 70 h 46~
Dim. w 27 9/16" d 27 9/16" h. 18 1/8"~

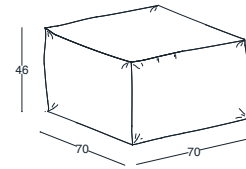

pouf SUN

Pouf c/interno in polistirolo, sfoderabile. Non realizzabile in pelle ed ecopelle.

Pouf filled with polystyrene, removable cover, not available in leather or eco-leather.

Dim. l 48 p 48 h 46~
Dim. w 18 7/8" d 18 7/8" h 18 1/8"~

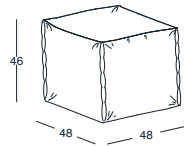

pag. 88.229



pouf MR. BEAN

Pouf c/interno in polistirolo, sfoderabile in tessuto e non sfoderabile in pelle ed ecopelle.

Pouf filled with polystyrene, removable cover in fabric, non-removable in leather or eco-leather.

Disponibile in 2 misure Ø 80 h 100 o Ø 100 h100 ~
Available in 2 sizes Ø 31 1/2" h. 39 3/8" or Ø 39 3/8" h 39 3/8"~

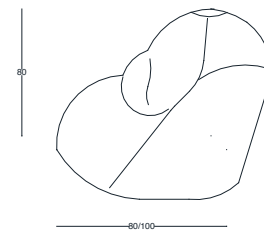

pouf DISC

Pouf c/interno in polistirolo, non sfoderabile.

Pouf filled with polystyrene, pouf with non removable cover.

Dim. Ø 120 h 35~
Dim. Ø 47 1/4" 13 6/8" h ~

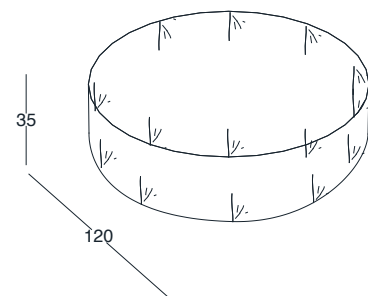

356



pouf ROUND

Pouf c/interno in polistirolo, sfoderabile in tessuto e non sfoderabile in pelle ed ecopelle.

Pouf filled with polystyrene, removable cover in fabric, non-removable in leather or eco-leather.

Dim. Ø 50 h 50~
Dim. Ø 19 11/16" h 19 11/16"~

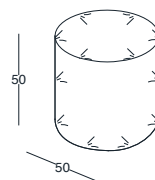

pag. 89



pouf POISSY

Pouf contenitore con coperchio trapuntato, non sfoderabile

Pouf with storage and quilted top, the pouf cover is not removable.

Dim. l 47 p 47 h 50
Dim. w 18 1/2" d 18 1/2" x h 19 11/16"

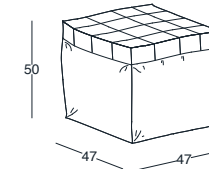

pouf RENNES

Pouf con contenitore con coperchio trapuntato, non sfoderabile.

Pouf with storage and quilted top, the pouf cover is not removable.

Dim. l 101 p 36 h 42
Dim. w 39 3/4" 15/16" d 14 3/16" h 16 1/2"

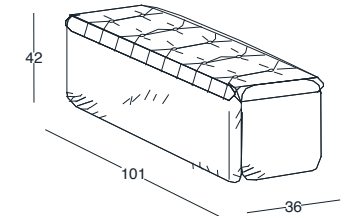

pouf PANDORA

Pouf con contenitore, completamente sfoderabile in tessuto e non sfoderabile in pelle ed ecopelle.

Pouf with storage, the pouf cover is completely removable in fabric e not removable in eco-leather or leather.

Dim. l 89/99 p 32 h 38
Dim. W 35/39 d 12 5/8" h 16 1/2"

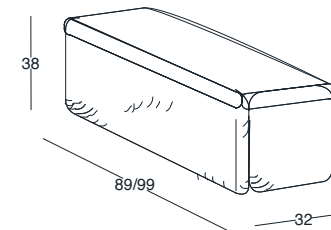

pag. 325



pouf EDITH

Pouf non sfoderabile.

Possibilità di inserire top in marmo nelle finiture brown silk, calacatta, emperador dark e fior di pesco, oppure c/postazione ricarica.

Caricatore USB pop-up per caricare due dispositivi. Carica contemporaneamente tablet e smartphone. Disponibile con ghiera in metallo e trasformatore da 12V.

The pouf cover is not removable.

Available with marble top in the following colors: brown silk, calacatta, emperador dark and fior di pesco, or with recharge station.

The USB charger pop-up can charge up to two devices at the same time, such as tablets e smartphones. Available with metal ring and 12V transformer.

Specifiche/Specifications:
• 2 porte USB per caricare / 2 USB ports to recharge

Dim. Ø 45 h.46
Dim. Ø 17 11/16" h. 18 1/8"

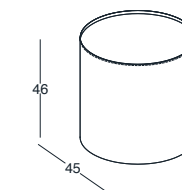

357



pag. 43



comodino SLIM

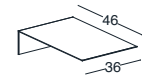

Comodino in acciaio laccato colori scala ral. 
 Bedside table in steel available lacquered in colour of ral system. 
 Dim. l 46 h 36
 Dim. w 18 1/8" d 14 3/16"



pag. 130.178



tavolino TEOREMA small

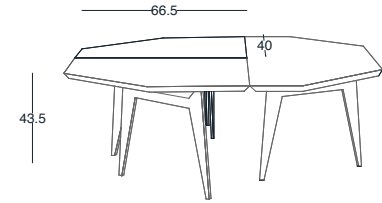

Struttura in acciaio verniciato a polveri con piano in mdf sagomato. 
 Finitura laccato scala ral. 
 Powder coated steel structure with MDF top that can be lacquered in any colour ref. ral system. 
 Dim. small 40-18 x 66,5 h 43,5
 Dim. small 15 1/2"- 7 1/16" x 26 3/16" h 17 1/8"



pag. 280



tavolino TEOREMA medium

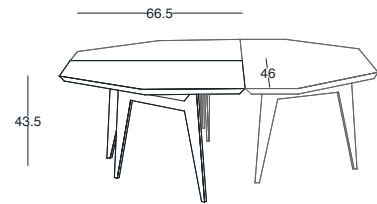

Struttura in acciaio verniciato a polveri con piano in mdf sagomato. 
 Finitura laccato scala ral. 
 Powder coated steel structure with MDF top that can be lacquered in any colour ref. ral system. 
 Dim. medium 46-24 x 66,5 h 43,5
 Dim. medium 18 1/8"-9 7/16" x 26 3/16" h 17 1/8"



pag. 300.301



tavolino TEOREMA large

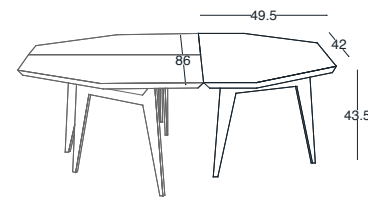

Struttura in acciaio verniciato a polveri con piano in mdf sagomato. 
 Finitura laccato scala ral. 
 Powder coated steel structure with MDF top that can be lacquered in any colour ref. ral system. 
 Dim. large 86/42 x 49,5 h 43,5
 Dim. large 33 7/8"-16 1/2" x 19 1/2" h 17 1/8"



pag. 301.302



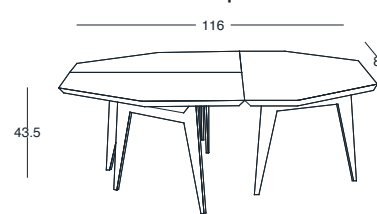

tavolino TEOREMA (3 pezzi)

Struttura in acciaio verniciato a polveri con piano in mdf sagomato. 
 Finitura laccato scala ral. 
 Powder coated steel structure with MDF top that can be lacquered in any colour ref. ral system. 
 Dim. 86 x 116 h 43,5
 Dim. 33 7/8" x 45 11/16" h 17 1/8"



tavolino FORTUNA (4 pezzi)

Struttura in acciaio verniciato a polveri con piano in mdf sagomato. 
 Finitura laccato scala ral. 
 Powder coated steel structure with MDF top that can be lacquered in any colour ref. ral system. 
 Dim. 99 x 99 h 43,5
 Dim. 39" x 39" 1/2" h 17 1/8"

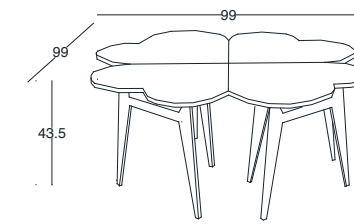



PANCHETTA ESPANA

Panchetta completamente sfoderabile in tessuto e non sfoderabile in pelle ed ecopelle.

The bench cover is completely removable in fabric e not removable in eco-leather or leather.

Dim. l 122 p 47 h.47
Dim. w 48" d 18 1/2" h. 18 1/2"

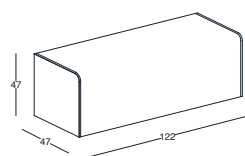

pag. 131



PANCHETTA TALLIS

Panchetta completamente sfoderabile in tessuto e non sfoderabile in pelle ed ecopelle.
Piedini disponibili finitura bronzo.

The bench cover is completely removable in fabric e not removable in eco-leather or leather.
Feet available in finishing bronze.

Dim. l 122 p 47 h.44
Dim. w 48" d 18 1/2" h. 17 5/16"

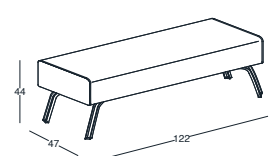

pag. 124



PANCHETTA TULIP

Panchetta disponibile nelle finiture: bronzo, laccato bianco ral 9010, nero ral 9011 e laccato rosso ral 3002.

Bench available in the following finishings: bronze or white ral 9010, black ral 9011 and red ral 3002 lacquered.

Dim. l. 122 p 48 h.38

Dim. w 48 d 18 7/8" h. 15

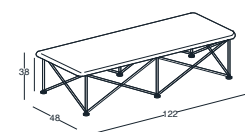

pag. 084.085



POLTRONCINA JILL

Poltroncina completamente sfoderabile in tessuto e non sfoderabile in pelle ed ecopelle.

The armchair cover is completely removable in fabric e not removable in eco-leather or leather.

Dim. l 80 p 72 h.72
Dim. w 31 1/2" d 28 3/8" h. 28 3/8"

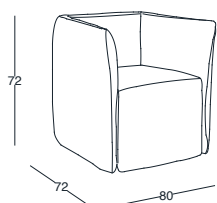

pag. 050.051



TAVOLINO JILL

Tavolino tripede finitura nero grafite con piano in marmo disponibile nelle finiture brown silk, calacatta, emperador dark o fior di pesco.

Small table with 3 legs finishing black graphite, with marble top available in the following colors: brown silk, calacatta, emperador dark and fior di pesco

Dim. Ø 45 o Ø 55 h. 40 o h.50

Dim. Ø 17 11/16" o Ø 21 11/16" h.15 3/4" h. 19 11/16"

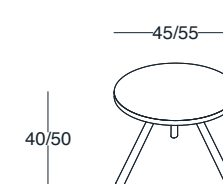

pag. 059



paravento SIGHTLY

Paravento non sfoderabile.

Non removable cover.

Dim. 60xh. 172
Dim. w 23 5/8" h. 67 11/16"

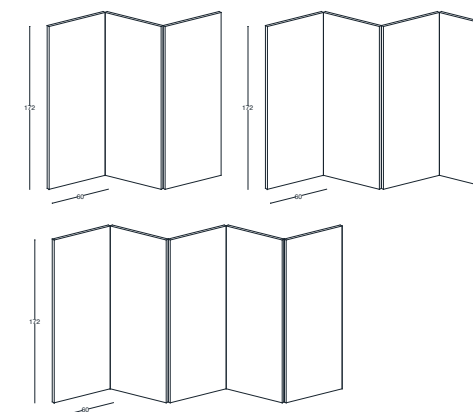

pag. 277



specchiera ILARY

Specchiera non sfoderabile, posizionabile in verticale od orizzontale, disponibile in qualsiasi misura.

Mirror with non removable cover, can be placed horizontally or vertically.
Available in all sizes.

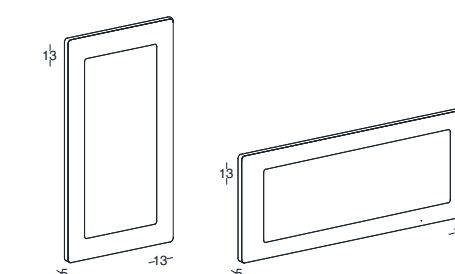

SERVOMUTO ZOE

Servomuto finitura oro rosa comprensivo pouf tondo sfoderabile in tessuto e non sfoderabile in pelle ed ecopelle.

Valet stand finishing pink gold including pouf tondo with removable cover in fabric, non-removable in leather or eco-leather.

Dim. l. 49.5 p 60 h.146

Dim. w 19 1/2" d 23 5/8" h. 57 1/2"

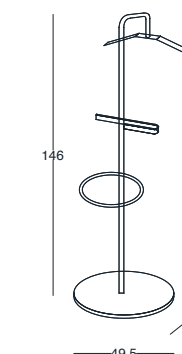

pag. 068 - 069

LE CUCITURE

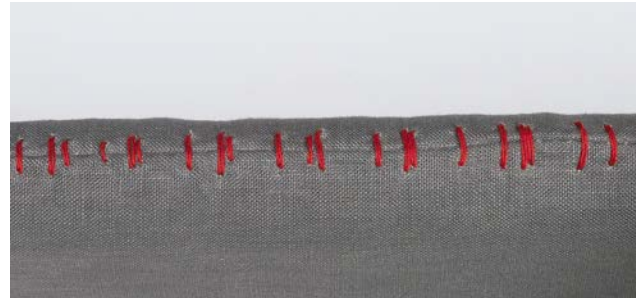

CUCITURA DELLA SARTA / SARTA SEAM

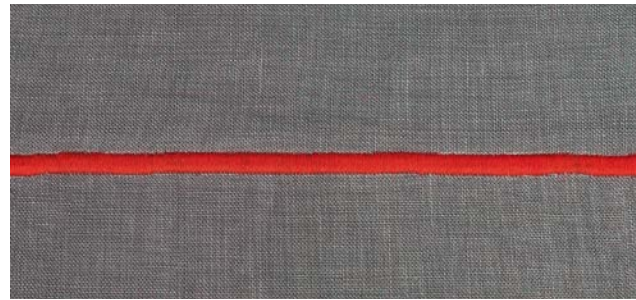

CUCITURA LINEARE STRETTA / LINEAR SEAM



CUCITURA LINEARE ZIG ZAG / ZIG ZAG LINEAR SEAM



BORDINO MORBIDO IN CONTRASTO / CONTRAST FABRIC EDGE



INSERTO PASSAMANERIA / WITH FABRIC STRIP



NERVETTO RIBATTITURA INGLESE / NORMAL SEAM



NERVETTO CON CODA DI TOPO / PIPING CODA DI TOPO



NERVETTO CON INSERTO IN CONTRASTO / INSERTED CONTRAST EDGE

LE CUCITURE



RICAMO CHIUSA / FLAT EMBROIDERY



TAGLIO VIVO / SHARP CUT

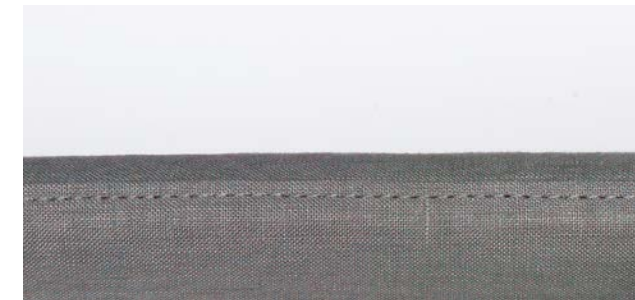

RIBATTITURA CHIUSA / RIBATTITURA CHIUSA



RICAMO APERTA / EDGE EMBROIDERY



RIBATTITURA APERTA / RIBATTITURA APERTA

CUCITURA RICAMO



CUCITURA LINEARE



CUCITURA LINEARE

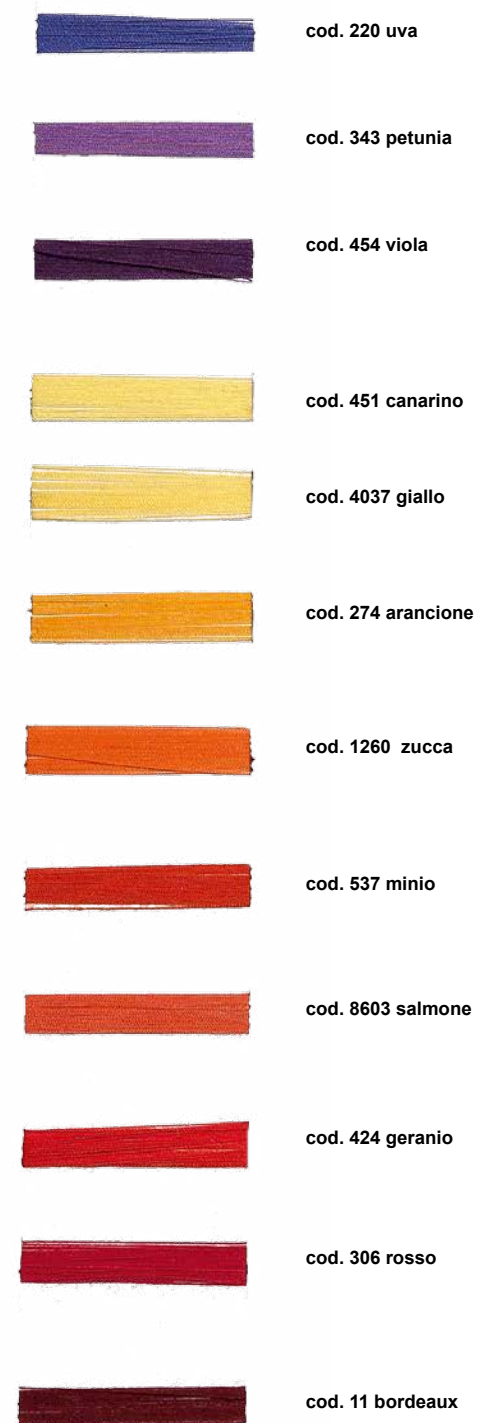

CUCITURA LINEARE

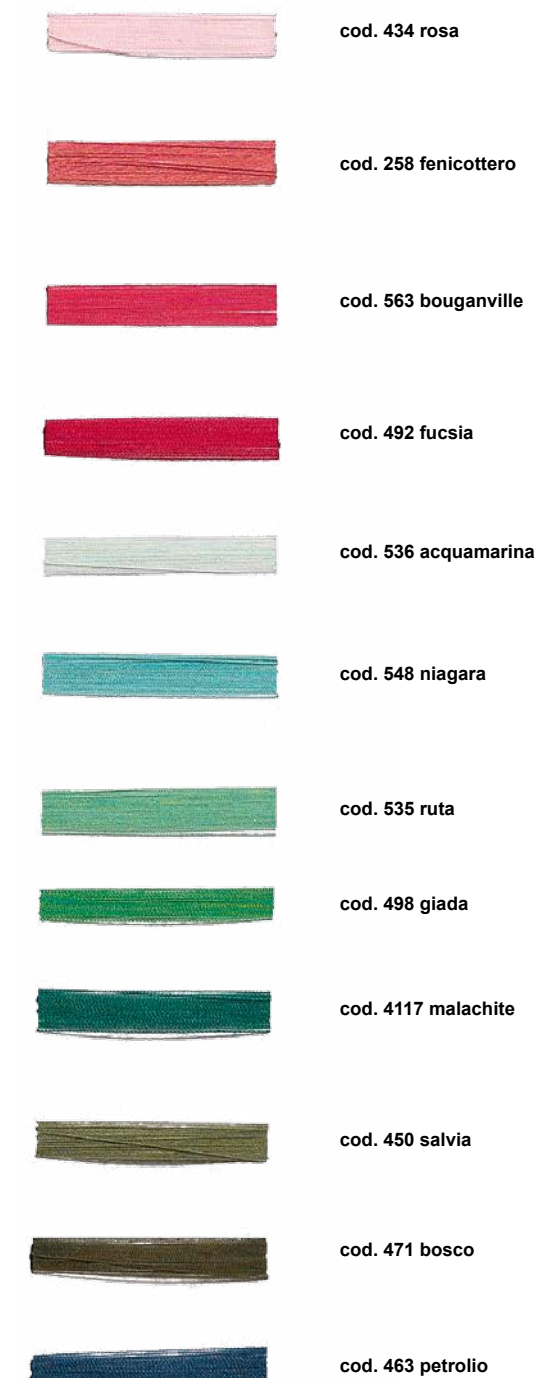

CUCITURA LINEARE

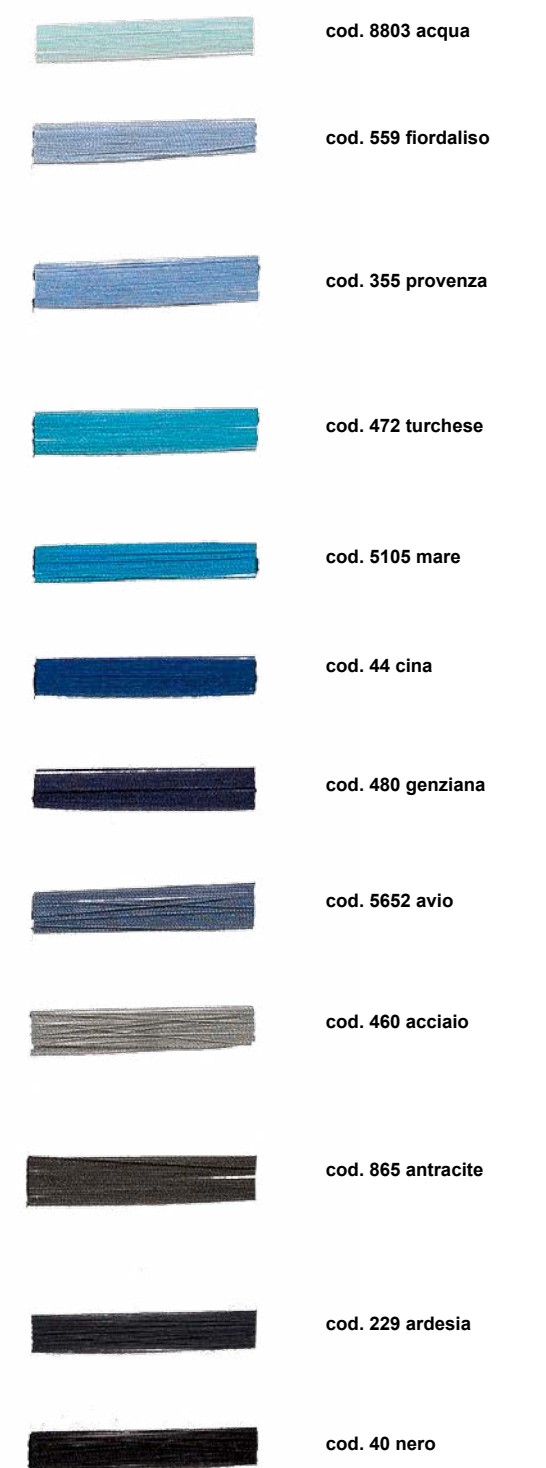

LA PASSAMANERIA



LA PASSAMANERIA



I TESSUTI



high 200
 las vegas 200
 wow 100
 rally 111
 melange 23
 wow 111
 high 104
 las vegas 616
 melange 20
 rally 602
 rally 406
 las vegas 622
 high 130
 rally 403
 las vegas 100



wow 503
 las vegas 07
 melange 10
 rally 308
 las vegas 08
 wow 305
 high 09
 melange 11
 las vegas 10
 melange 14
 melange 12
 wow 900
 rally 005
 wow 901
 high 3060

high
 Composizione: 100% pl
 idrorepellente/water repellent

las vegas
 Composizione: 85% pl 15% vi
 antimacchia/stain-resistant

melange
 Composizione: 54% pl 46% co

rally
 Composizione: 100% pl
 idrorepellente/water repellent
 irrestingibile/no shrink
 smacchiabile/stain cleanable

wow
 Composizione: 100% pl
 idrorepellente/water repellent
 oliorepellente: oil-repellent
 antiodore/anti-odour
 irrestingibile/no shrink
 smacchiabile/stain cleanable

CAT-D

I TESSUTI



melange 09
 melange 07
 melange 08
 wow 804
 rally 811
 las vegas 24
 las vegas 204
 wow 801
 high 27
 wow 607
 las vegas 2100
 high 11
 wow 405
 rally 405
 wow 608

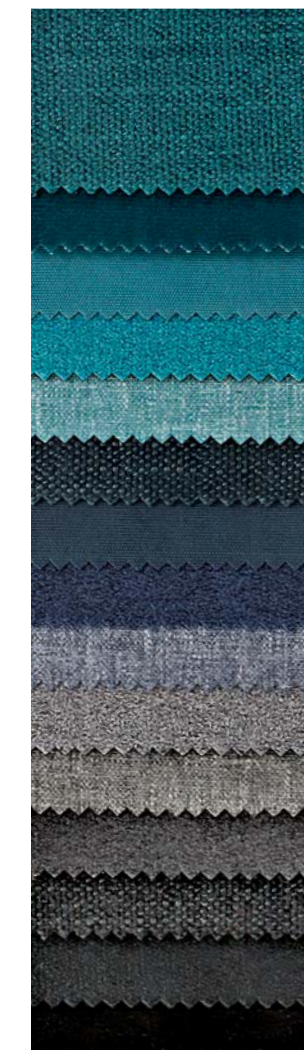

las vegas 16
 high 15
 wow 711
 rally 711
 melange 04
 las vegas 14
 wow 705
 rally 705
 melange 01
 rally 601
 melange 19
 rally 600
 las vegas 18
 rally 200
 high 18

high
 Composizione: 100% pl
 idrorepellente/water repellent

las vegas
 Composizione: 85% pl 15% vi
 antimacchia/stain-resistant

melange
 Composizione: 54% pl 46% co

rally
 Composizione: 100% pl
 idrorepellente/water repellent
 irrestingibile/no shrink
 smacchiabile/stain cleanable

wow
 Composizione: 100% pl
 idrorepellente/water repellent
 oliorepellente: oil-repellent
 antiodore/anti-odour
 irrestingibile/no shrink
 smacchiabile/stain cleanable

CAT-D

I TESSUTI



- extrema au 150
- hot 203
- piquant 103
- bub 2
- hot 210
- rebel 3
- pop 102
- piquant 110
- extrema au 450
- piquant 106
- hot 206
- rebel 5
- hot 209
- bub 14
- piquant 109
- pop 114

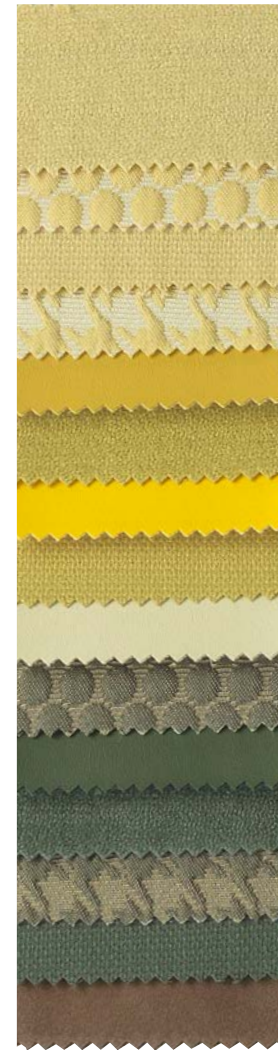

- hot 253
- bub 06
- piquant 153
- pop 106
- extrema au 650
- hot 200
- extrema au 2350
- piquant 100
- extrema au 250
- bub 7
- extrema au 1550
- hot 238
- pop 107
- piquant 138
- rebel 4

ignifughi
 Composizione bub, hot, piquant, pop: 100% pes
 Composizione ecopelle extrema au: 63% pu 29%
 cot 8% pes
 Composizione ecopelle rebel: 68% pvc 2% pu 30%
 pes/cot
 100% MADE IN ITALY

CAT-A

I TESSUTI



- extrema au 2850
- piquant 189
- pop 115
- hot 289
- bub 15
- extrema au 950
- pop 110
- piquant 136
- bub 10
- hot 236
- pop 109
- piquant 124
- bub 9
- hot 224
- extrema au 1350
- bub 13



- hot 249
- pop 108
- piquant 149
- bub 8
- extrema au 1950
- bub 11
- piquant 125
- pop 111
- hot 225
- hot 228
- extrema au 2150
- bub 16
- pop 116
- piquant 128
- pop 113
- hot 233



- piquant 146
- hot 246
- bub 1
- pop 101
- extrema au 2050
- rebel 6

I TESSUTI

shabby



23



04

22

01

05

33

12

24

13

31



16

21

06

08

09

10

35

17

15

Shabby
Composizione: 100% li

100% MADE IN ITALY

CAT-A

I TESSUTI

wool



OV 100

404

401

402

405

801

802

502

303



302

003

001

OV 003

OV 703

OV 702

701

702

201

Wool
Composizione: 70% wo - 25% pa - 5% af

100% MADE IN ITALY

CAT-A

canapa



2

32

4

33

34

40

41

6

42



20

36

21

29

22

23

46

24

44

Canapa
Composizione: 22% co - 37% vi - 18% li - 23% pl

100% MADE IN ITALY

CAT-A

I TESSUTI

aston



Aston
Composizione: 100% pl
100% MADE IN ITALY

CAT-A

nobilis

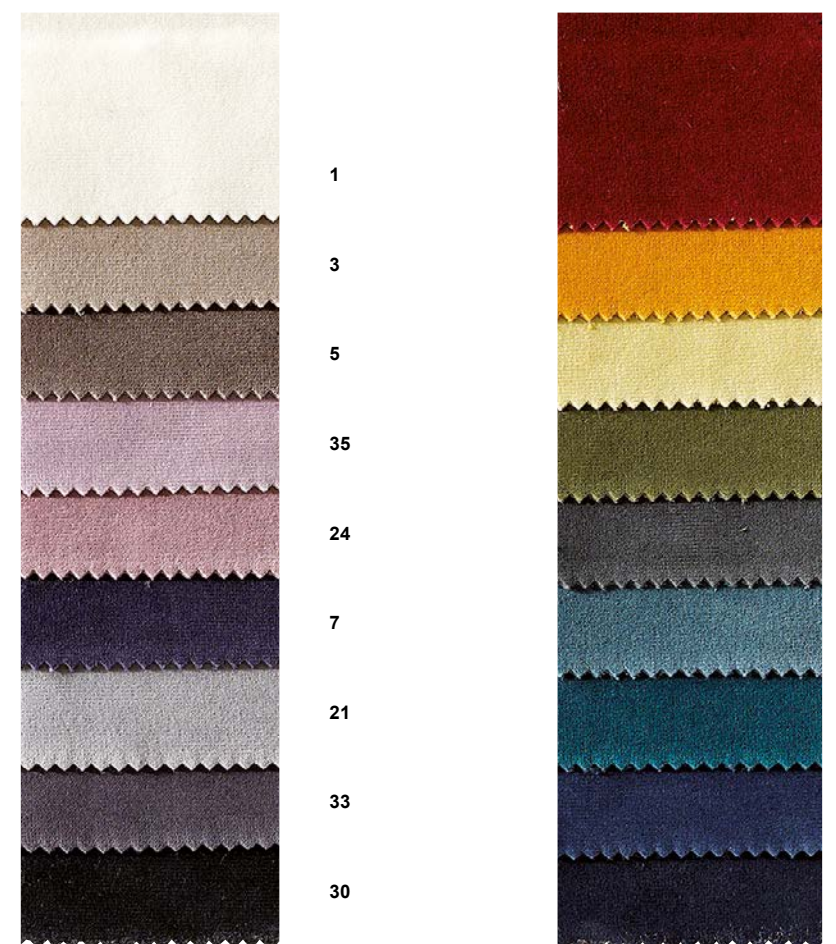

Nobilis
Composizione: 100% co
100% MADE IN ITALY

CAT-PLUS

I TESSUTI

rubelli



100% MADE IN ITALY

LE PELLI

panama



Pelle

100% MADE IN ITALY

CAT-LUX

LE PELLI

nuvola



Pelle

100% MADE IN EUROPE

CAT-PELLE

LE PELLI

nuvola



Pelle

100% MADE IN EUROPE

CAT-PELLE

LE PELLI

nuvola

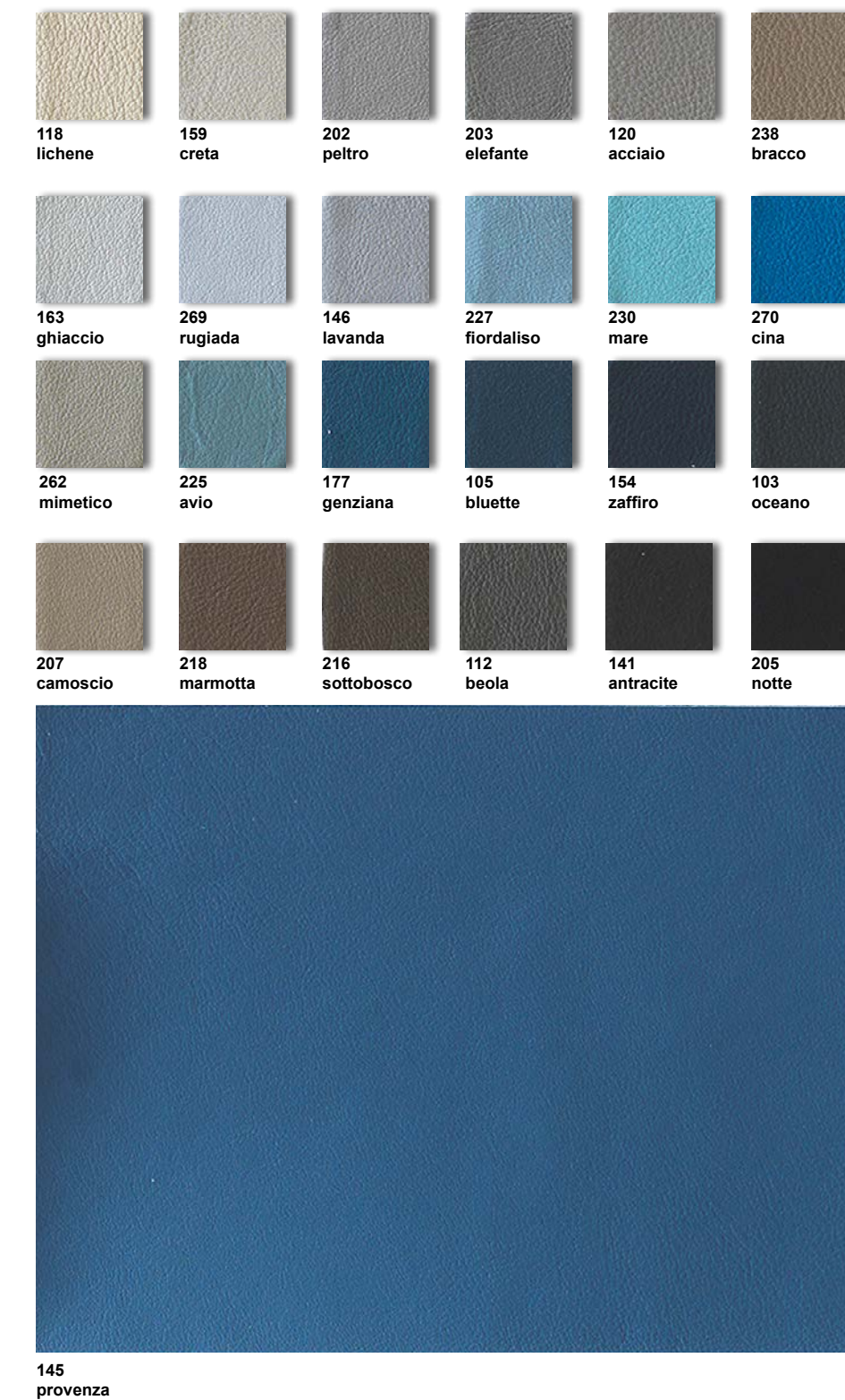

Pelle

100% MADE IN EUROPE

CAT-PELLE

145
provenza

LE PELLI

nabuk

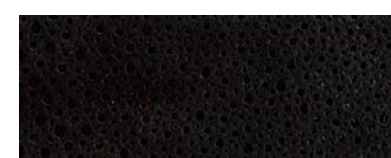
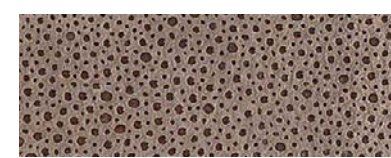
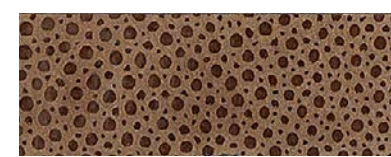
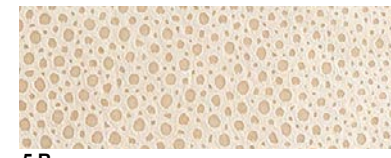

Pelle
100% made in europe

CAT-PELLE

LE PELLI

nabuk

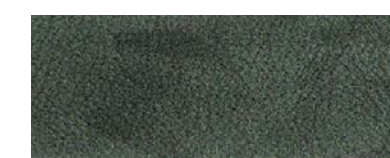
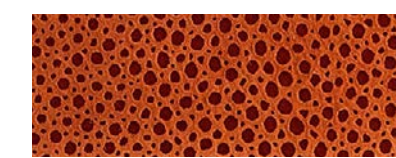
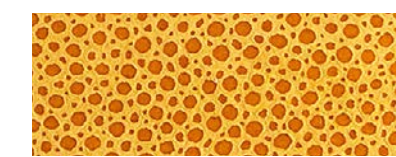
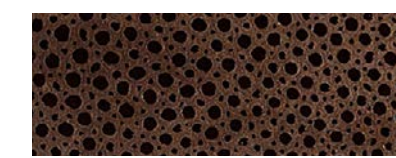
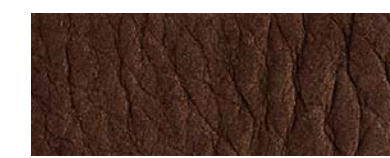
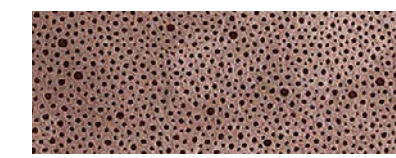
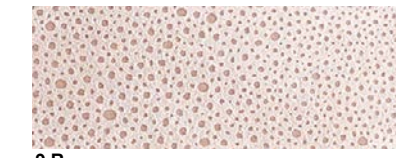

Pelle
100% made in europe

CAT-PELLE

NOTE

NOTE

progetto Andrea Bassanello

copy Andrea Bassanello

fotografia Gabriotti

stylist Carla Bernardis

stampa Grafiche Antiga

printed 2017

Bolzan letti s.r.l. al fine di migliorare le caratteristiche tecniche e qualitative della sua produzione, si riserva di apportare, anche senza preavviso, tutte le modifiche che si rendessero necessarie.

Bolzan letti s.r.l. reserves the right to make all the changes deemed necessary to the products in order to improve technical and quality features, even without advanced notice.

