

Bellagio
H O M E

Bellagio Collection designed by Anna and Enrico Cattaneo

CREATIVITÀ E TECNOLOGIA
APPLICATA ALLO STILE ITALIANO

Creativity and technology
applied to italian style

La tradizione del made in Italy viene spesso citata,
a volte viene superata da nuove tendenze,
per noi è fonte di ispirazione continuamente rinnovata.
Amiamo la creatività che coglie le proposte della tecnologia
e le applica ad un modo di vivere più armonioso e consapevole dell'importanza
della bellezza negli ambienti quotidiani.
Queste sono per noi le radici del più genuino stile italiano.

The tradition of Made in Italy is often mentioned, and new trends sometimes
seem to overcome it, yet for us it is a source of constantly renewed inspiration. We
love the kind of creativity that manages to harness new technological proposals,
applying them to a way of life that is more harmonious and aware of the
importance of beauty in everyday environments.
For us, these are the very roots of the most genuine Italian style.



Dal mondo della moda e delle luxury cars
ci siamo ispirati per cercare uno stile elegante
e riconoscibile.

Un segno delicato, un fil rouge che percorra tutti
gli ambienti della casa con uguale sicurezza,
coordinando un'idea glamour del made in Italy.

We took inspiration from the world of fashion and
luxury cars looking for an elegant, recognisable
style. A delicate sign, a fil-rouge that could runs
across all of the spaces of your home with equal
confidence, coordinating a glamorous idea of
made in Italy.

UN CONCEPT
GLAMOUR E INNOVATIVO

A glamorous
and innovative concept



La delicata e riconoscibile texture matelassè segna le creazioni fashion più famose e denota uno stile che rifugge il freddo minimalismo così come l'inutile decorazione, reinventando uno stile da sempre inconfondibile.

The delicate yet recognisable texture of matelassé patterns marks the most famous fashion creations, outlining a design that shies away from cold minimalism as well as useless decorations, aiming to reinvent an unmistakable style.

UNA FORMA
INCONFONDIBILMENTE
TRASVERSALE

A shape that is unmistakably
across-the-board



Una delicata texture tridimensionale
ispirata alla classica finitura matelassè
del mondo fashion, si declina in raffinate nuance
laccate, lucide, opache e metalliche.
Il decoro romboidale si sposa anche con ante
in vetro inciso e rivestimenti in tessuto.

A delicate three-dimensional texture inspired by
the classic matelassé finish borrowed from the
world of fashion, inflected in refined lacquered,
glossy, opaque or metallic nuances.
The rhomboidal decoration marries happily
with engraved glass and the fabric upholstery
of the shutter doors.

UNA DELICATA TEXTURE
TRIDIMENSIONALE

A beautiful and delicate
three-dimensional texture

LIVING | 12

La zona living, destinata ad accogliere gli ospiti e ad affacciarsi sul mondo, è certamente la parte della casa che immediatamente rivela lo stile di chi la abita. Mobili, complementi, accessori e boiserie presentano lo stile coordinato ed elegante di Bellagio.

The living area, designed to be a welcoming place for guests as well as an overlook onto the world, is certainly the most striking part of a house, as it reveals the style of its inhabitants at first glance. Furniture, accessories, and boiserie and all sport the elegant, coordinated design of Bellagio, a quintessential Italian style.

KITCHEN | 34

La cucina Bellagio non rinuncia ad essere originale ed elegantissima, coordinata con le altre zone della casa, senza dimenticare la funzionalità e la tecnologia all'avanguardia propria di questo particolare ambiente.

The Bellagio kitchen was born under the sign of Made in Italy, with no compromise as for utmost elegance and originality, in coordination with the other areas of the home, yet bearing in mind functionality and those state-of-the-art technologies that typify this specific environment.

NIGHT | 50

Nella parte più intima e privata della casa, lo stile Bellagio si declina in complementi, armadi e boiserie con una continuità discreta e ricercata allo stesso tempo.

In the most intimate part of your home, the Bellagio style is reproduced throughout accessories, wardrobes and boiseries, with discrete yet refined continuity.

VANITY | 72

L'ambiente bagno accoglie pienamente la decorazione matelassé, i materiali pregiati come pietre e marmi e le laccature su anta decoro o liscia. Si completano con vasche sottotop o da appoggio in ceramica e vetro.

On completion of your Bellagio home, even the bathroom fully welcomes matelassé decorations, with precious materials such as stone and marbles, lacquered finishes over decorated or smooth shutter doors. Undermount or freestanding bathtubs, in ceramic or glass, complete the bathroom area.



Bellagio
HOME

Bellagio Collection designed by Anna and Enrico Cattaneo



Bellagio
L I V I N G



L'ARREDO LIVING È CARATTERIZZATO
DA COMPLEMENTI ELEGANTEMENTE COORDINATI

The living room decor includes furnishing
accessories coordinated with elegance

Vetrinette in laccato Lino opaco >
con vetro liscio bronzato riflettente.
Display cabinets in matte "Lino" lacquer with
smooth, bronzed reflective glass.

Madia bassa, laccato Lino opaco con gambe >
nero poro aperto e top incassato marmo Emperador
Low cupboard in matte "Lino" lacquer with
open pore black legs and built-in Emperador marble top





^
Ambiente living declinato nella versione laccato Lino opaco
e pannelli boiserie in laccato Fondente lucido.
Living area declined in its matte "Lino" lacquer version,
wall panelling in glossy "Fondente" lacquer.



Vetrinette con anta a vetro bronzato, disponibili nella versione liscia e con decoro a rombi incisi.
 Display cabinets with bronzed glass shutters, available in smooth version and with engraved rhombus-shaped decoration.

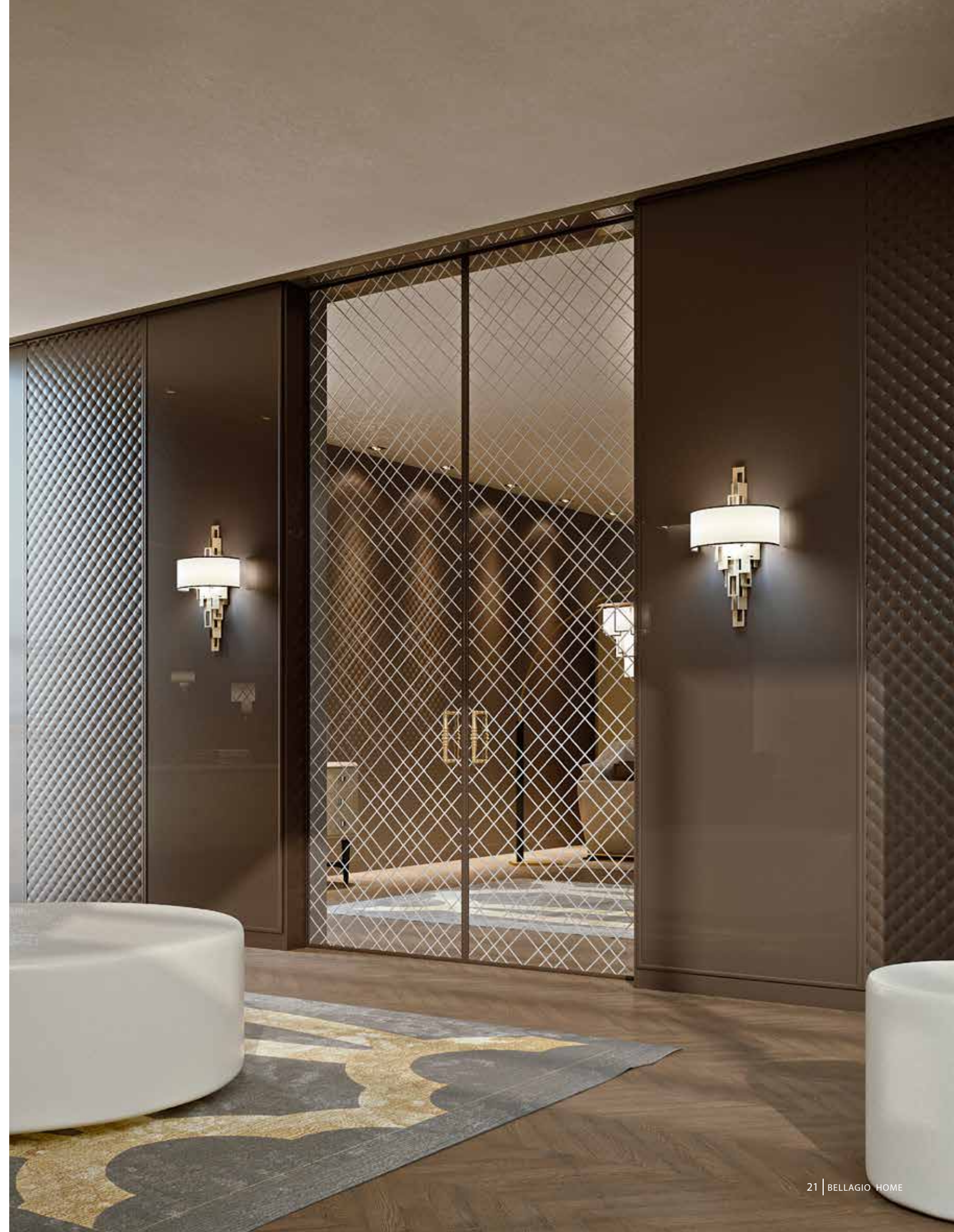

Pannelli boiserie declinati nelle versioni: >
 laccato Fondente lucido, liscio e matelassé e specchio inciso.
 Panelling declined in three different versions: glossy
 "Fondente" lacquer, smooth and quilted with engraved mirror.



Madia laccato Lino opaco con gambe, >
su boiserie laccato Fondente opaco e specchio inciso.
Sideboard in matte "Lino" lacquer with legs over wood panels in
matte "Fondente" lacquer and engraved mirrors.





^
Madia bassa e tavolino in laccato Lino lucido.
Boiserie in laccato Fondente lucido e specchio inciso bronzato.
Low cupboard and coffee table in glossy "Lino" lacquer.
Glossy "Fondente" wood panelling and engraved bronzed mirror.



La forma del raccordo terminale è seguita dal top in marmo e dal basamento in legno. The marble top and wooden base follow the shape of the terminal junction.

< I complementi possono essere perfettamente coordinati nella stessa finitura dei pannelli boiserie. Nella foto madia laccato Canapa lucido su gambe e basamento noce Canaletto.

All the accessories can be seamlessly coordinated using the same finishes of the wall panels. Picture: Cupboard in glossy "Canapa" lacquer over legs and pedestal in "Noce Canaletto".



Il colpo d'occhio è importante quanto l'esame ravvicinato dei dettagli che compongono un ambiente, per questo ogni elemento è stato disegnato e realizzato con la massima cura e la laccatura lucida e opaca esalta ogni delicato volume del modello Bellagio.

The first glance is arguably as important as a close inspection of all the details that form a kitchen. For this reason, every element was designed and manufactured with the utmost care. Furthermore, the opaque or glossy lacquer brings out any delicate curve and volume of the Bellagio Model.

DISEGNO COORDINATO
ED ESTESA MODULARITÀ

Coordinated design
and extensive modularity



^
La boiserie in un luminoso laccato Crema opaco crea un piacevole contrasto con i complementi declinati in laccato Basalto opaco.
The Wood panels in a bright matte "Crema" lacquer create a pleasant contrast with the accessories declined in matte "Basalto" lacquer.



Ampio mobile contenitore con ante laccate matelassé opaco e vano a giorno con schienale a specchio bronzato inciso.
Large cabinet with lacquered doors in matte Matelassé and open unit with bronzed mirror engraved back-panel.

< Boiserie laccato Crema opaco e pannelli in specchio bronzato inciso.
Panelling in matte "Crema" lacquer and engraved panels in bronzed mirror.

Bellagio
KITCHEN



^
Elegante composizione in laccato Fondente opaco con top apribile e schienale in marmo Striato Elegante.
Elegant composition in matte "Fondente" lacquer with foldout top and back panel in "Striato Elegante" marble.



< Il piano apribile nasconde la zona lavaggio e cottura.
Lifting top with washing and cooking area.



Gola per apertura basi laccata in tinta con le ante.
Handle-less opening colour-matched with the shutter doors.

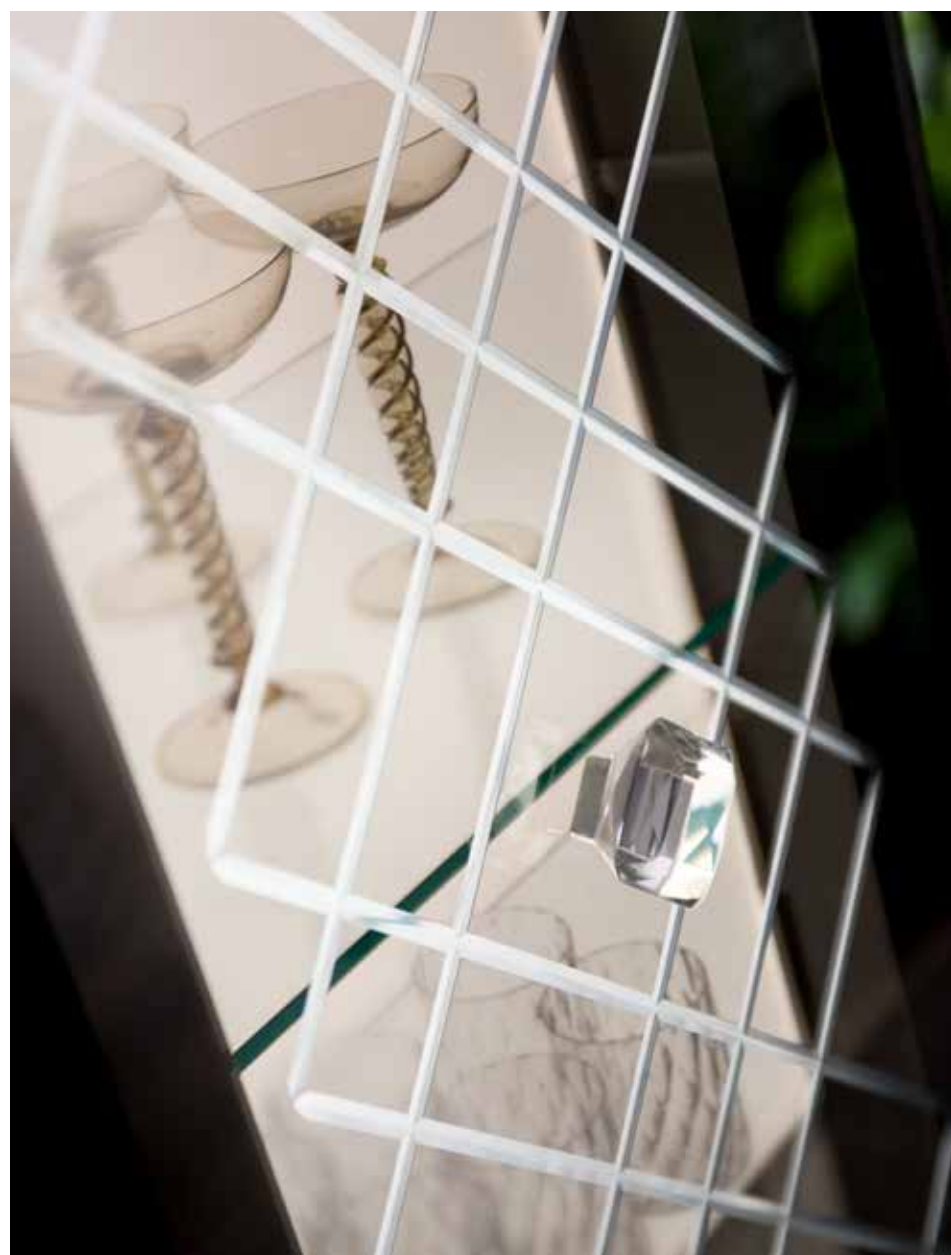

Raffinato dettaglio del pomolo gioiello su anta vetro e ripiani interni in cristallo.
Fine detail of the jewel-like knob installed onto the glass door and inner crystal shelves.

Vetrinette in laccato Fondente lucido con piedini Noce Canaletto. >
Ante in vetro bronzato riflettente inciso e schienale retro illuminato.
Display Cabinets in glossy "Fondente" lacquer with feet in "Noce Canaletto".
Reflective bronzed glass doors with backlit etched back.

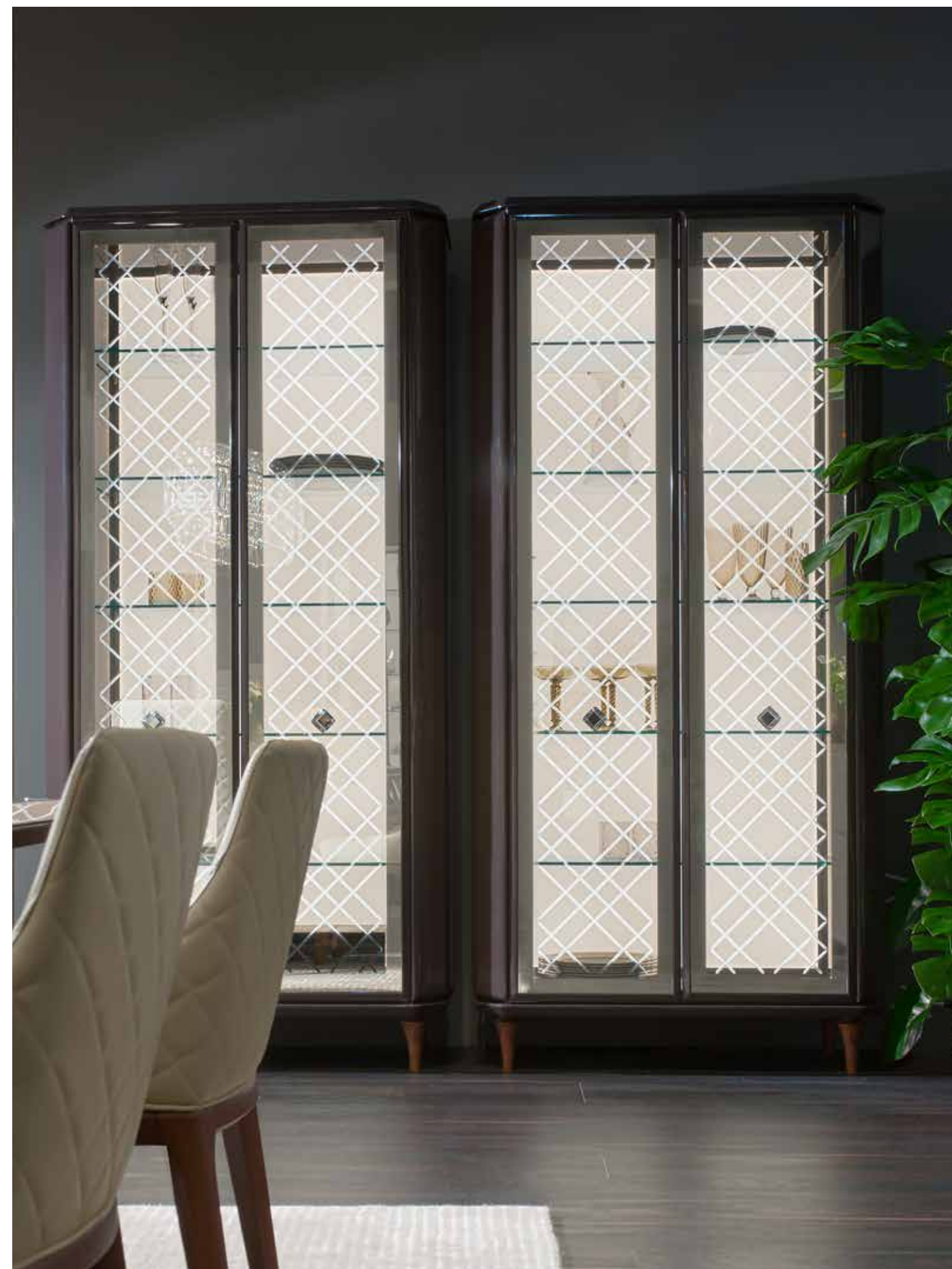



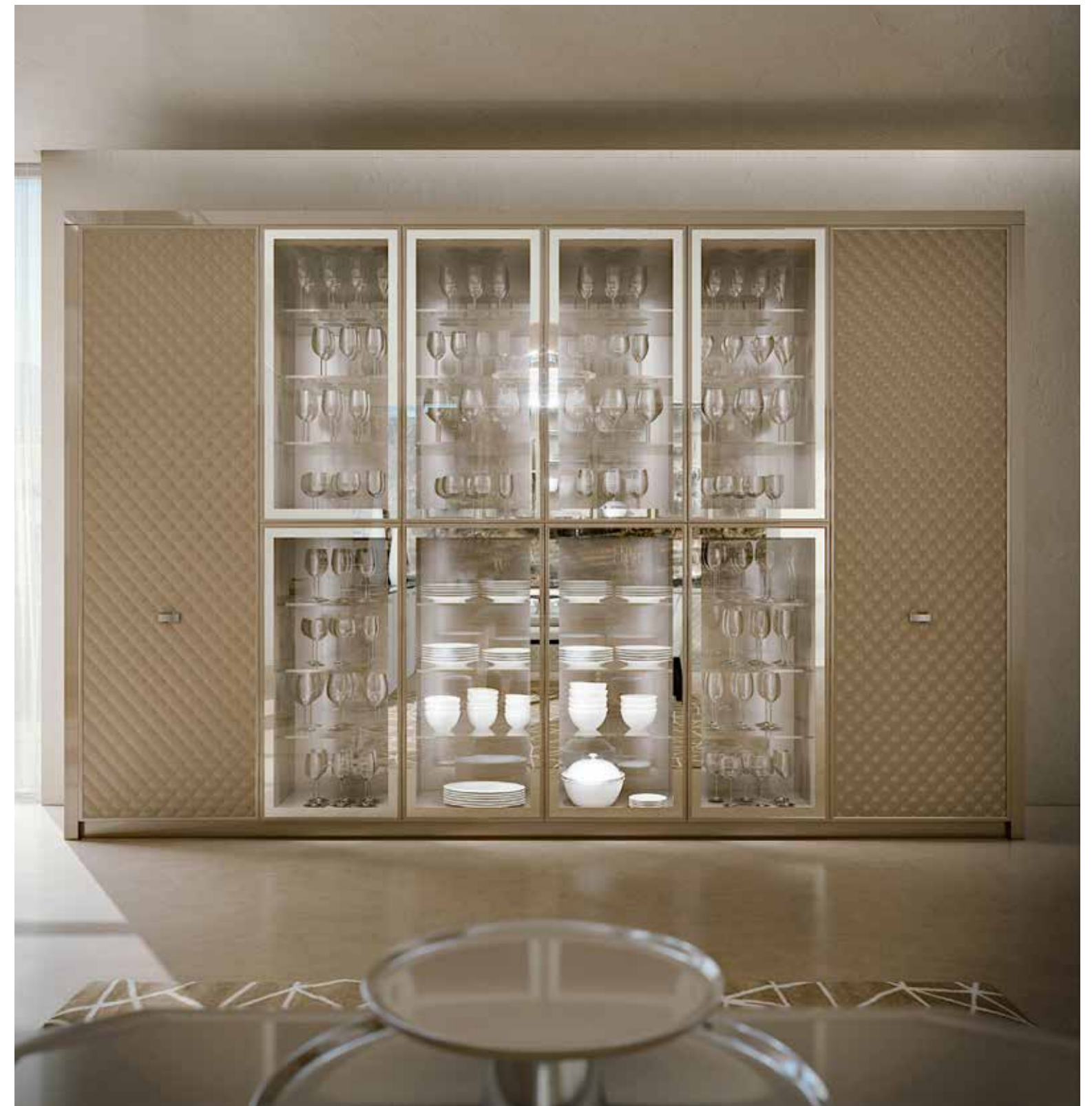

Raffinata composizione in laccato Lino lucido e top in marmo Emperador.
Exquisite composition in glossy "Lino" lacquer with Emperador marble top.



Composizione in laccato Crema con ante in vetro laccato liscio e inciso. Complementi coordinati. Lacquered "Crema" composition with smooth or etched lacquered glass doors and matching accessories.



L'apertura di questo modello miscela con naturalezza il pomolo gioiello delle colonne con la gola laccata delle basi.
In the opening of this model, the jewel-like knob used for the columns blends naturally with the lacquered handle-less opening grooved in the bases.

Ante nella versione vetro laccato Crema, liscio e inciso.
Le vetrine riportano lo stesso disegno su vetro trasparente.
Schienale in marmo Calacata Oro.
Shutter doors in their smooth and engraved glass versions, mounted on colour-matched panels

Bellagio
N I G H T

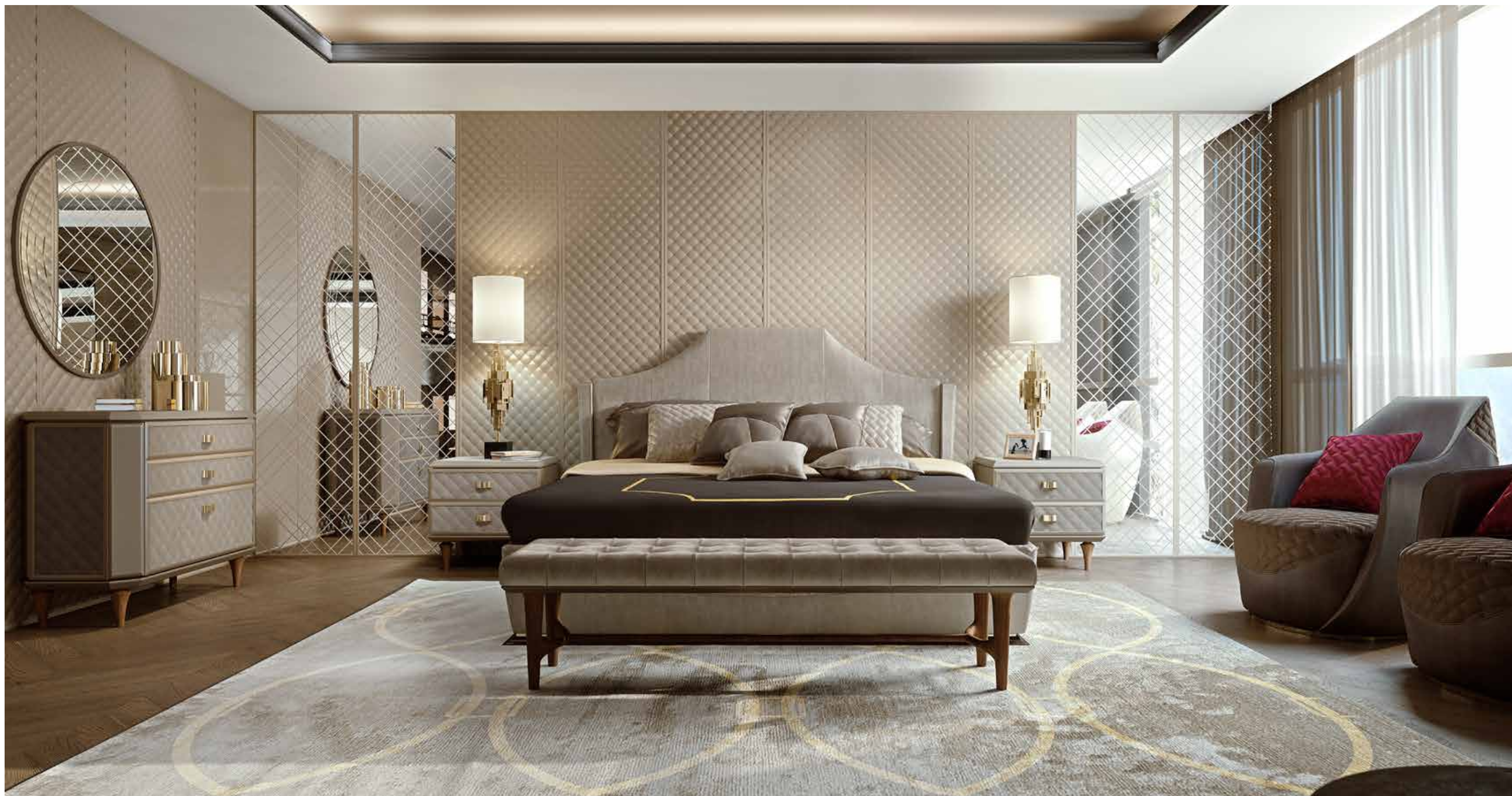

Un ambiente notte elegante e personalizzato in ogni dettaglio.
Comò, comodini e panca sono in laccato Creta opaco e tessuto coordinato.
An elegant sleeping area personalized in every detail.
Chest of drawers, bedside tables and bench in matte "Creta" lacquer with coordinated fabric. Feet and legs in "Noce Canaletto".

La tonalità calda della laccatura Lino lucido per la boiserie
è interrotta da ampie pannellature a specchio inciso.
The warm tones of the glossy "Lino" lacquer used for the wood panelling are interrupted by large etched mirror panels.

ELEGANZA COORDINATA
PER DECORO E COLORI
NELLA ZONA NOTTE

Coordinated elegance
for the colours and decors
of the sleeping area

Comò in versione liscia laccato Greige opaco. >
Boiserie laccato Greige lucido e maniglie colore oro.
Dresser declined in its smooth matte "Greige" lacquer version.
Wood panelling in glossy "Greige" lacquer and gold handles.





^
Un ambiente di grande importanza: il guardaroba, composto da armadio con ante a vetro bronzato riflettente, cassettiera e settimanali.
A highly significant area: the wardrobe, consisting of a cupboard with reflective bronzed glass doors, dressers and chests of seven drawers.



< Complementi di taglio classico e moderna capacità contenitiva, i due settimanali in laccato opaco e tessuto sono impreziositi da pomoli in cristallo diamantato
Furnishing accessories with a classic cut and modern storage capacity, the two chests of seven drawers in opaque lacquer and fabric are embellished with diamond-shaped crystal knobs.



Dettaglio top con inserto in vetro bronzato acidato.
Detail of the top, with inserts in bronzed etched glass.



La grande specchiera con bordo inciso accompagna >
la preziosa toeletta con inserti in tessuto matelasse.
The large mirror with etched frame accompanies the
precious dressing table with inserts in Matelassé fabric.



Nella parte più intima e privata della casa,
lo stile Bellagio si declina in complementi,
armadi e boiserie con una continuità discreta
e ricercata allo stesso tempo.
Pannelli, decoro, laccature, ogni dettaglio
ripropone il leit-motiv dell'eleganza italiana.

In the most intimate part of your home,
the Bellagio style is reproduced throughout
accessories, wardrobes and boiserie,
with discrete yet refined continuity.
Panels, lacquering, decorations,
each and every detail refiles the leitmotif
of Italian elegance

OGNI DETTAGLIO DELLA CASA
COORDINABILE
IN STILE BELLAGIO HOME

Every detail of your home
coordinated with
the bellagio style



^

La boiserie laccata grigio Basalto opaco dona il giusto risalto ai complementi in laccato Bianco lucido.
The wood panelling in matte "Basalto" grey gives due prominence to the accessories, lacquered in glossy white.



UN DELICATO
RILIEVO LACCATO
PIACEVOLE AL TATTO

A gently embossed
lacquered detail,
pleasant to the touch

< Cassettiera in versione matelassé laccato lucido
e boiserie in laccato Basalto opaco.
Chest of drawers in its quilted glossy version,
panelling in matte "Basalto" lacquer.

COMÒ, SETTIMANALI,
SPECCHI E BOISERIE
COMPLETANO
LA ZONA NOTTE BELLAGIO

Dressers, chests of drawers,
consoles, mirrors and boiserie
complete the Bellagio
sleeping area.

I settimanali si affiancano al grande specchio con sottile cornice
laccata e incisione con decoro Bellagio.
The chests of seven drawers sit alongside the big mirror, enclosed
within a thin glossy frame with engraved Bellagio decorations.







Bellagio
VANITY



^
Soluzione doppio lavabo su top marmo Emperador
con ante matelassé laccato Bianco Sale opaco e gambe
Noce Canaletto.
Double washbasin solution over Emperador marble top
with Matelassé "Bianco Sale" lacquer doors and legs in
"Noce Canaletto".



< Lavabi gemelli con top marmo Emperador e ante matelassè laccato Greige opaco e gambe Noce Canaletto.

Twin washbasins with Emperador marble top and shutters quilted and lacquered in matte "Greige", legs in "Noce Canaletto".



MATERIALI PREZIOSI
COORDINATI
CON LO STILE BELLAGIO
ANCHE PER LA ZONA BAGNO

Even the bathroom area includes
precious materials coordinated
according to the bellagio style

Lavabi gemelli con top marmo Bianco di Carrara e ante >
matelassé laccato Polvere opaco e gambe nero poro aperto.
Twin washbasins with top in white Carrara marble and matte
"Polvere" lacquered doors with legs in black open pore lacquer.





^

Lavabi in ceramica sottopiano su top in marmo Bianco di Carrara per una soluzione dai toni raffinati in laccato Polvere opaco.

Ceramic undermount washbasins over white Carrara marble top for a sophisticated tonal solution in matte "Polvere" lacquer.

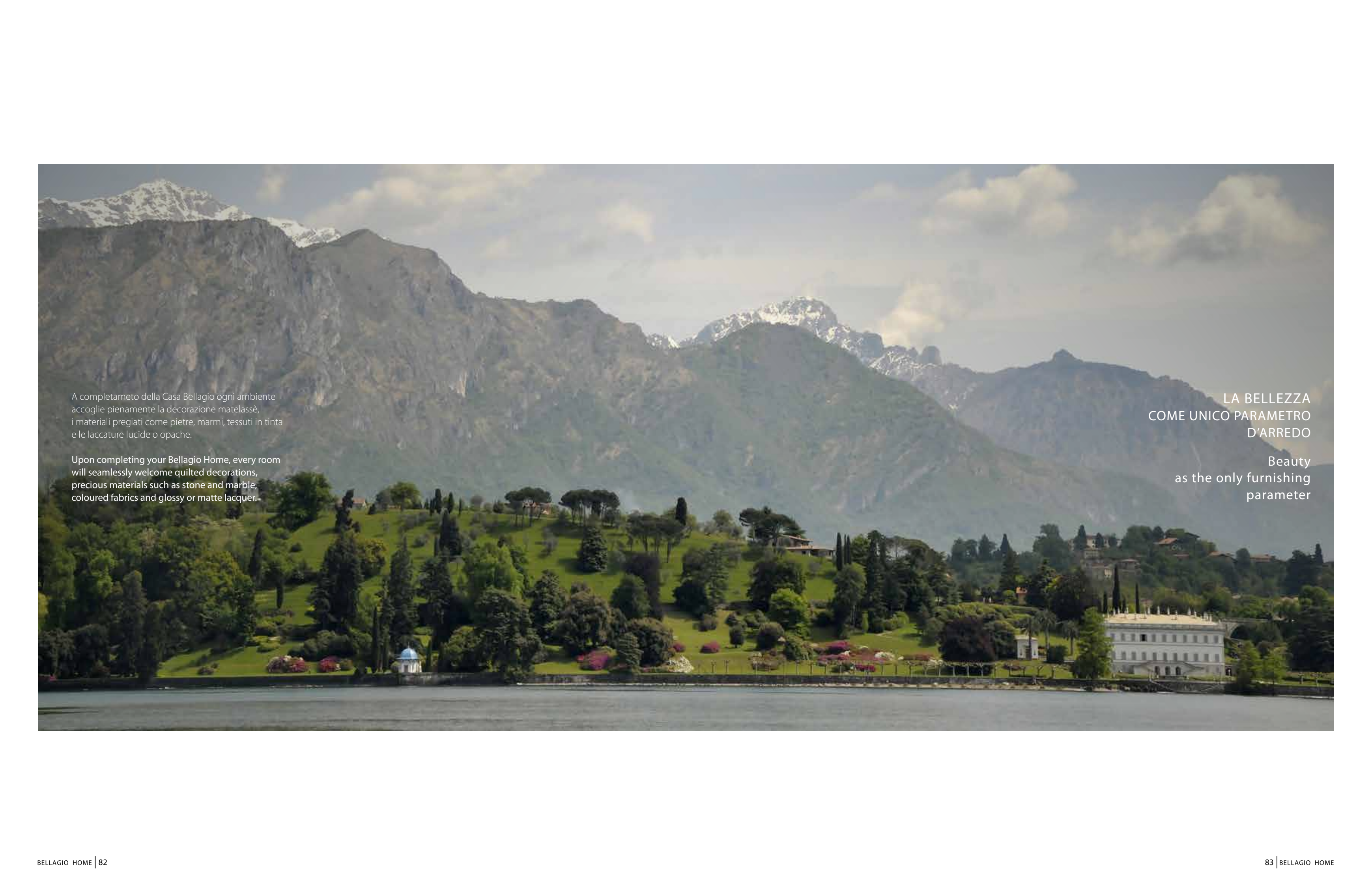

A completamento della Casa Bellagio ogni ambiente accoglie pienamente la decorazione matelassè, i materiali pregiati come pietre, marmi, tessuti in tinta e le laccature lucide o opache.

Upon completing your Bellagio Home, every room will seamlessly welcome quilted decorations, precious materials such as stone and marble, coloured fabrics and glossy or matte lacquer.

LA BELLEZZA
COME UNICO PARAMETRO
D'ARREDO

Beauty
as the only furnishing
parameter













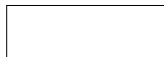
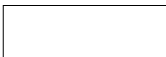







ANTA LACCATA

Lacquered door

Anta laccato opaco, lucido e soft touch.
 Disponibile nelle versioni con pannello liscio o matelassé
 Matt, glossy or soft touch lacquered door.
 Available in in smooth or matelassé panel versions.



Colori Colors

			
Bianco ottico	Bianco sale 20191.16	Greige	Crema
			
Lino	Canapa	Basalto	Mastice
			
Terra	Creta	Fondente	Moka
			
Oltremare	Ottanio	Nero 20192.16	Polvere
			
Seta	Ardesia	Ferro	Ghiaia

Liquid metal

					
Fumo di Londra	Grigio Nevada	Mercurio	Perla	Palladio	Oro

Laccato metallico Metallic lacquered

		
Bronzo	Peltro	Platino



ANTA VETRO LACCATO E SPECCHIO Lacquered glass and mirror door

Anta con pannello vetro laccato lucido, riflettente nero o bronzato, specchio verniciato cromo. Disponibili nelle versioni con superficie liscia o incisa rombi. Door with lacquered glossy glass panel, reflective black or bronze, painted chrome mirror. Available in mirror smooth surface or engraved rhombus surface



Colori Colors

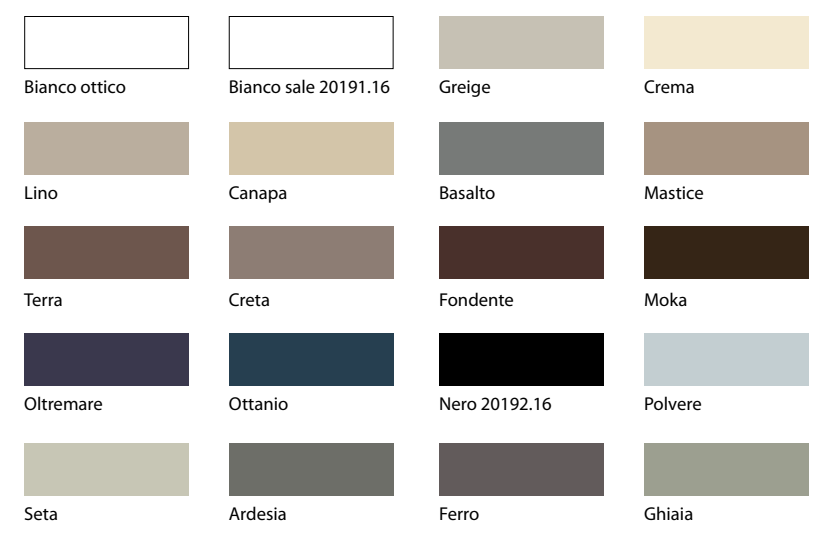



ANTA TESSUTO
Fabric door

Anta con pannello centrale rivestito in tessuto.
Disponibile nelle versioni con pannello liscio o matelassé.
Door with central panel covered in fabric.
Available in in smooth or matelassé panel versions.



- Tessuto 2100
- Tessuto 18
- Tessuto 100
- Tessuto 2
- Tessuto 104
- Tessuto 130



ANTA VETRINA Showcase door

Anta vetrina con vetro trasparente o vetro bronzato riflettente.
Disponibile nelle versioni liscia o a rombi incisi.
Showcase door with transparent glass or reflective bronze glass.
Available in smooth surface or engraved rhombus surface





SEDUTE
Seats

Sedia, capotavola e sgabello
con struttura noce Canaletto, nero poro aperto o laccato.
Rivestimento in pelle.
Chair, head of the table and stool
with Canaletto walnut, black open pore or lacquered structure.
Leather upholstery.



COD. 238



COD. 288



COD. 289



Pannelli boiserie componibili.
Disponibili nelle versioni laccato, vetro, specchio e tessuto.
Modular panelling.
Available in lacquer, glass, mirror and fabric versions

Pannello laccato, liscio o matelassé
Vetro retrolaccato, liscio o inciso
Specchio, liscio o inciso
Pannello rivestito in tessuto, liscio o matelassé
Lacquered, smooth or matelassé panel
Rear-lacquered, smooth or engraved glass
Smooth or engraved mirror
panel with fabric covering smooth or matelassé

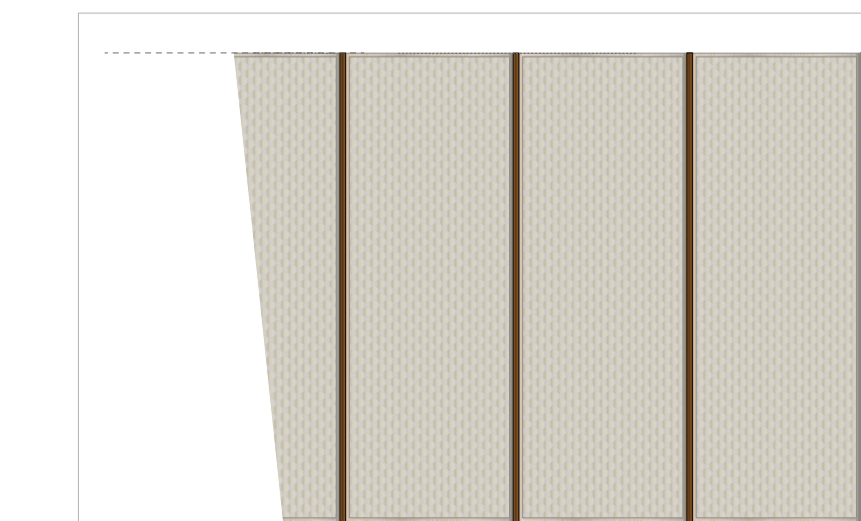

Profilo centrale laccato
lacquered central profile

Profilo terminale laccato
lacquered ending profile

Dimensioni_Dimensions
H 250,5 / 207,6
L 44,7 / 59,7 / 75,7 / 89,7 / 119,7
Per matelassé e rombi larghezza massima 75,5cm
For matelassé and engraved rhombus surface
maximum width cm 75,5

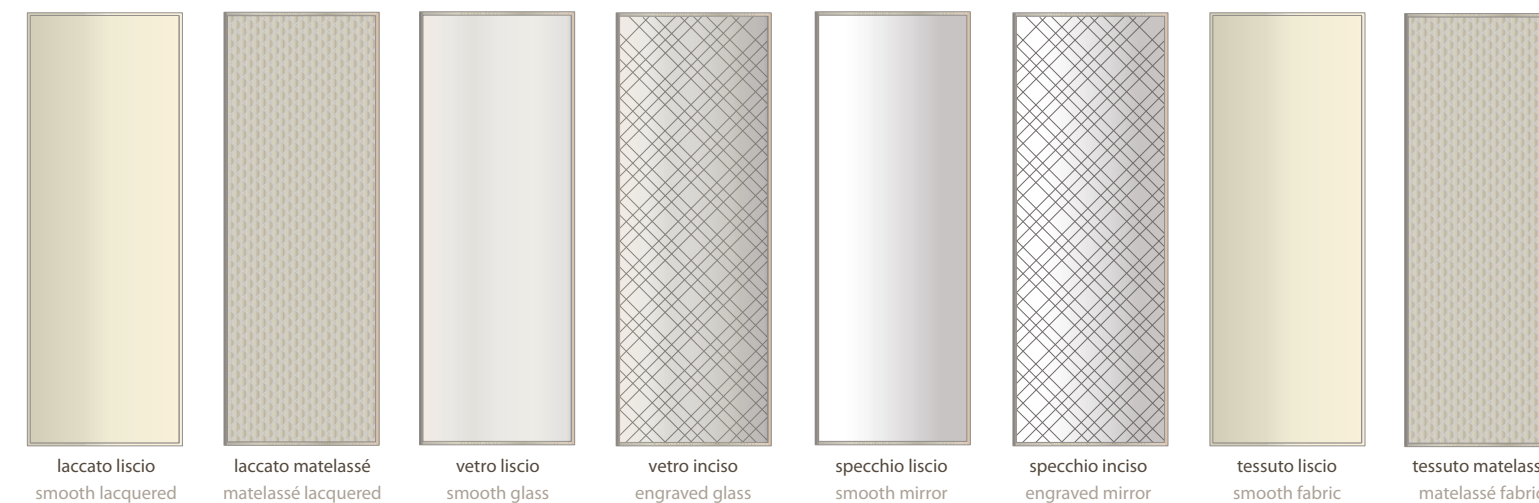

laccato liscio smooth lacquered laccato matelassé matelassé lacquered vetro liscio smooth glass vetro inciso engraved glass specchio liscio smooth mirror specchio inciso engraved mirror tessuto liscio smooth fabric tessuto matelassé matelassé fabric

MANUALE TECNICO
Technical specification

TAVOLI CON GAMBE

tables with legs

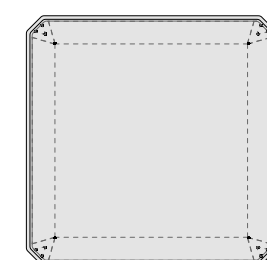
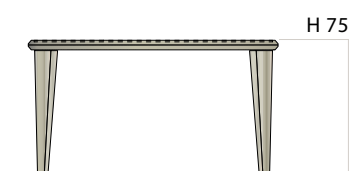

misure piano - top measures
140 x 140_COD. 900
180 x 180_COD. 1063

Struttura in laccato o nero poro aperto.
La lastra inserita nel top è proposta
in vetro liscio retrolaccato,
a richiesta è possibile realizzare la lastra in marmo.
Lacquered or black open pore structure
The slab inserted into the top is available
in rear-lacquered smooth glass,
on request it is possible to realize the marble slab.

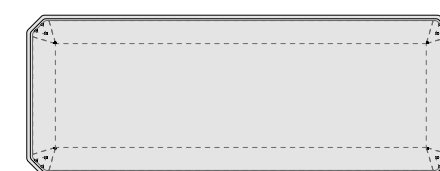
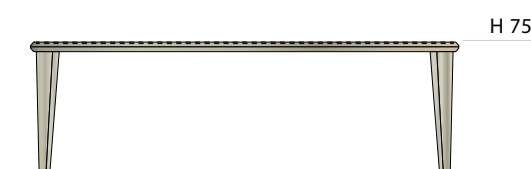

misure piano - top measures
90 x 180_COD. 900
90 x 200_COD. 950
100 x 240_COD. 1150
100 x 280_COD. 1450

Struttura in laccato o nero poro aperto.
La lastra inserita nel top è proposta
in vetro liscio retrolaccato,
a richiesta è possibile realizzare la lastra in marmo.
Lacquered or black open pore structure
The slab inserted into the top is available
in rear-lacquered smooth glass,
on request it is possible to realize the marble slab.

Riferimento pag. 43
Page reference 43

TAVOLI CON GAMBA CILINDRICA

Tables with cylindrical leg

Gamba matelassé cilindrica e piede laccati
La lastra inserita nel top è proposta
in vetro liscio retrolaccato,
a richiesta è possibile realizzare la lastra in marmo.
Lacquered cylindrical matelassé leg and foot.
The slab inserted into the top is available
in rear-lacquered smooth glass,
on request it is possible to realize the marble slab.

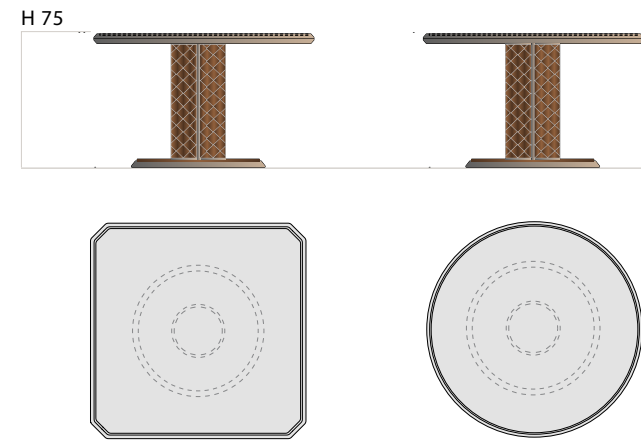

misure piano - top measures
120 x 120_COD. 1350
140 x 140_COD. 1400

misure piano - top measures
ø 120_COD. 1350
ø 150_COD. 1400

Gamba matelassé cilindrica e piede laccati
La lastra inserita nel top è proposta
in vetro liscio retrolaccato,
a richiesta è possibile realizzare la lastra in marmo.
Lacquered cylindrical matelassé leg and foot.
The slab inserted into the top is available
in rear-lacquered smooth glass,
on request it is possible to realize the marble slab.

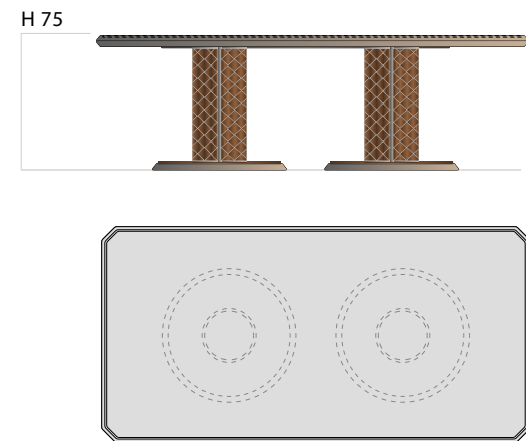

misure piano - top measures
100 x 200_COD. 1850
120 x 200_COD. 1900
120 x 240_COD. 2150
120 x 280_COD. 2350

Riferimento pag. 15
Page reference 15

TAVOLINI CON GAMBA CILINDRICA

Coffe tables with cylindrical leg

Gamba matelassé cilindrica e piede laccati
La lastra inserita nel top è proposta
in vetro liscio retrolaccato,
a richiesta è possibile realizzare la lastra in marmo.
Lacquered cylindrical matelassé leg and foot.
The slab inserted into the top is available
in rear-lacquered smooth glass,
on request it is possible to realize the marble slab.

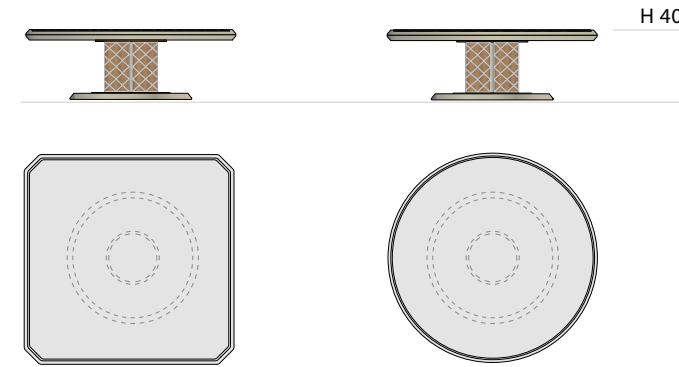

misure piano - top measures
100 x 100_COD. 1100
120 x 120_COD. 1150

misure piano - top measures
ø 100_COD. 1100
ø 120_COD. 1150

Tavolino con piano quadrato riferimento pag. 25
Coffee table with square top page reference 25

Gamba matelassé cilindrica e piede laccati
La lastra inserita nel top è proposta
in vetro liscio retrolaccato,
a richiesta è possibile realizzare la lastra in marmo.
Lacquered cylindrical matelassé leg and foot.
The slab inserted into the top is available
in rear-lacquered smooth glass,
on request it is possible to realize the marble slab.

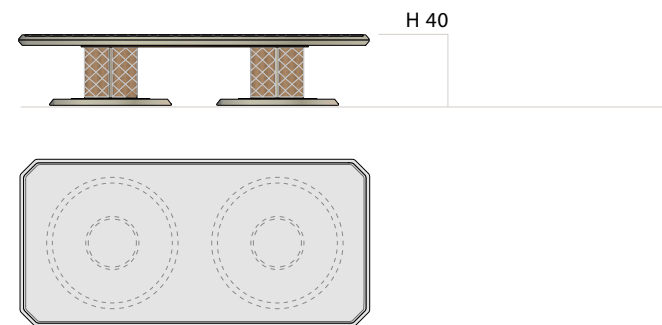

misure piano - top measures
100 x 200_COD. 1510

MADIE CON PIEDINI

sideboard with stud feet

La lastra inserita nel top con incavo è proposta in vetro liscio retrolaccato, a richiesta è possibile realizzare la lastra in marmo, o l'intero top in marmo. I piedini, il basamento e il top con incavo sono disponibili in noce Canaletto, nero poro aperto o laccato. Le madie sono disponibili nelle profondità 52,9 o 62,5 cm. The slab inserted into the recessed top is available in rear-lacquered smooth glass, on request it is possible to realize the marble slab or the whole top in marble. The feet, the base and the recessed top are available in Canaletto walnut, black open pore or lacquered. The cupboards are available in 52,9 or 62,5 cm deep.

Riferimento pag. 57
Page reference 57

LISCIO OPACO smooth matt_COD. 1155
LISCIO LUCIDO smooth glossy_COD. 1387
MATELASSÈ OPACO matt_COD. 1278
MATELASSÈ LUCIDO glossy_COD. 1518
(Mobile a parete_Wall stand unit)

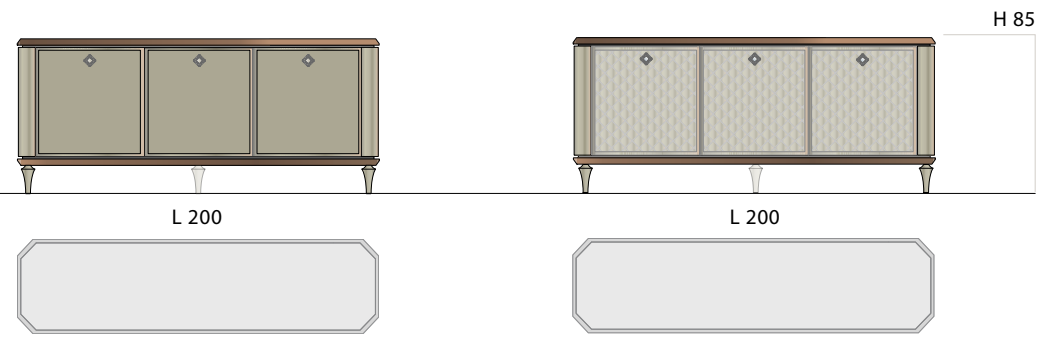

MADIE CON GAMBE

sideboards with legs

Le madie con gambe sono disponibili con ante a battente, a ribalta e cassetti in legno. La lastra inserita nel top con incavo è proposta in vetro liscio retrolaccato, a richiesta è possibile realizzare la lastra in marmo, o l'intero top in marmo. Le gambe, il basamento e il top con incavo sono disponibili in noce Canaletto, nero poro aperto o laccato. Le madie sono disponibili nelle profondità 52,9 o 62,5 cm. The cupboards with legs are available with hinged doors, tip-up opening and wood drawers. The slab inserted into the recessed top is available in rear-lacquered smooth glass, on request it is possible to realize the marble slab or the whole top in marble. The legs, the base and the recessed top are available in Canaletto walnut, black open pore or lacquered. The cupboards are available in 52,9 or 62,5 cm deep.

Riferimento pag. 23
Page reference 23

LISCIO OPACO smooth matt_COD. 1387
LISCIO LUCIDO smooth glossy_COD. 1599
MATELASSÈ OPACO matt_COD. 1456
MATELASSÈ LUCIDO glossy_COD. 1679
(Mobile a parete_Wall stand unit)



Riferimento pag. 17
Page reference 17

LISCIO OPACO smooth matt_COD. 1313
LISCIO LUCIDO smooth glossy_COD. 1509
MATELASSÈ OPACO matt_COD. 1400
MATELASSÈ LUCIDO glossy_COD. 1621
(Mobile a parete_Wall stand unit)

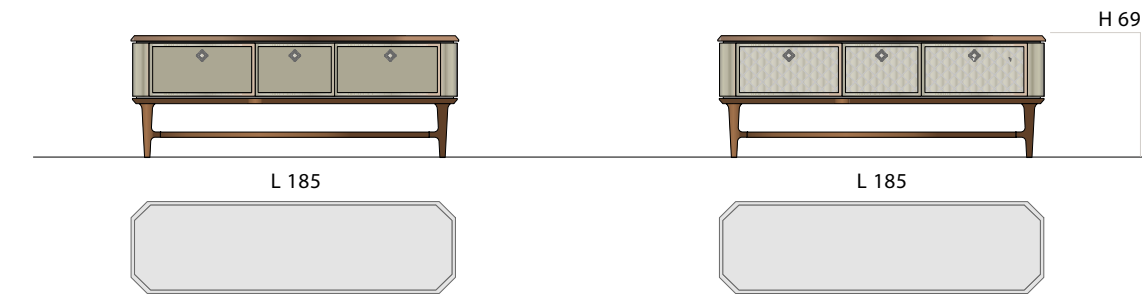

Alzatina con mensola in vetro extra chiaro
Upstand with glass shelf extra
COD. 225 ml

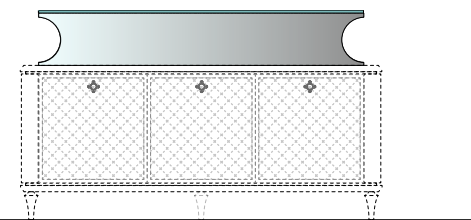

Riferimento pag. 24
Page reference 24

LISCIO OPACO smooth matt_COD. 1290
LISCIO LUCIDO smooth glossy_COD. 1408
MATELASSÈ OPACO matt_COD. 1386
MATELASSÈ LUCIDO glossy_COD. 1600
(Mobile a parete_Wall stand unit)

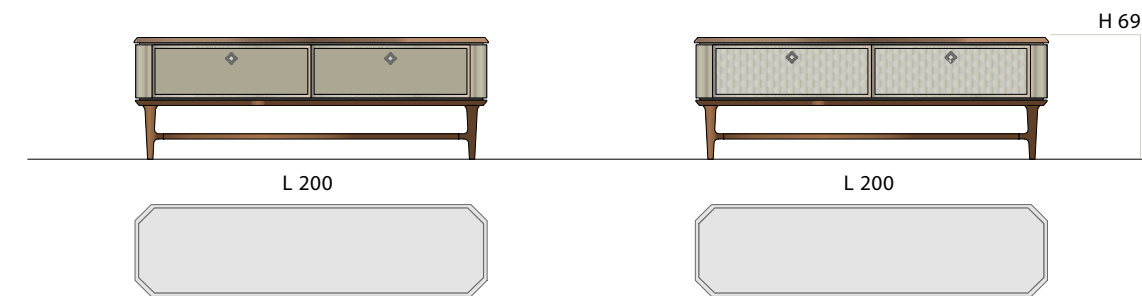

VETRINE

Cabinets

Le ante delle vetrine sono disponibili nelle versioni vetro liscio e inciso. A richiesta è possibile avere lo schienale luminoso. I piedini, il basamento e il top superiore sono disponibili in noce Canaletto, nero poro aperto o laccato. Le vetrine sono disponibili nelle profondità 52,9 o 62,5 cm. The doors of the cabinets are available in smooth glass and engraved versions. On request is possible to have the luminous back. The stood feet, the base and the upper top are available in Canaletto walnut, black open pore or lacquered. The cabinets are available in 52,9 or 62,5 cm deep.

Riferimento pag. 20 / 41
Page reference 20 / 41

OPACO VETRO LISICIO matt smooth glass_COD. 1297
LUCIDO VETRO LISICIO glossy smooth glass_COD. 1550
OPACO VETRO INCISO matt engraved glass_COD. 1515
LUCIDO VETRO INCISO glossy engraved glass_COD. 1753
(Mobile a parete_Wall stand unit)



L 110

L 110

COMPLEMENTI NOTTE

night complements

Gamma di cassettiere, comodini, settimanali e complementi per la zona notte. La lastra inserita nel top con incavo è proposta in vetro liscio retrolaccato, a richiesta è possibile realizzare la lastra in marmo, o l'intero top in marmo, ad esclusione di comodini e settimanali dove il top è laccato. I cassetti sono in legno. I piedini, il basamento e il top con incavo sono disponibili in noce Canaletto, nero poro aperto o laccato. Disponibili nelle profondità 52,9 e 62,5 cm. Range of chests of drawers, bedside, and complements for the bedroom. The slab inserted into the recessed top is available in rear-lacquered smooth glass, on request it is possible to realize the marble slab or the whole top in marble, with the exception of bedside and chests of seven drawers, where the top is lacquered. The drawers are made of wood. The feet, the base and theand the recessed top are available in Canaletto walnut, black open pore or lacquered. Available in 52,9 and 62,5 cm depth.

Riferimento pag. 23
Page reference 23

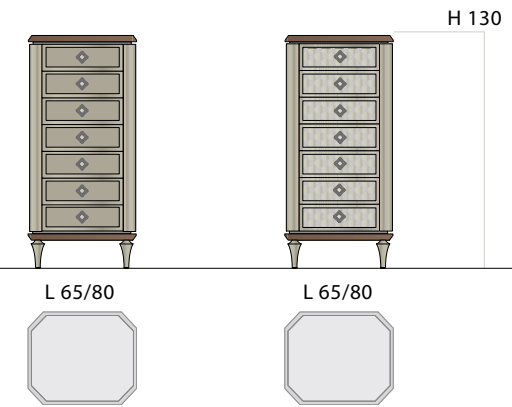

L 65/80

L 65/80

LISCIO OPACO smooth matt
L 65 COD. 890_L 80 COD. 960
LISCIO LUCIDO smooth glossy
L 65 COD. 1170_L 80 COD. 1280
MATELASSÈ OPACO matt
L 65 COD. 989_L 80 COD. 1058
MATELASSÈ LUCIDO glossy
L 65 COD. 1197_L 80 COD. 1280
(Mobile a parete_Wall stand unit)

Riferimento pag. 52 / 66
Page reference 52 / 66



L 140

L 140

LISCIO OPACO smooth matt_COD. 1108
LISCIO LUCIDO smooth glossy_COD. 1330
MATELASSÈ OPACO matt_COD. 1206
MATELASSÈ LUCIDO glossy_COD. 1408
(Mobile a parete_Wall stand unit)

Riferimento pag. 55 / 71
Page reference 55 / 71

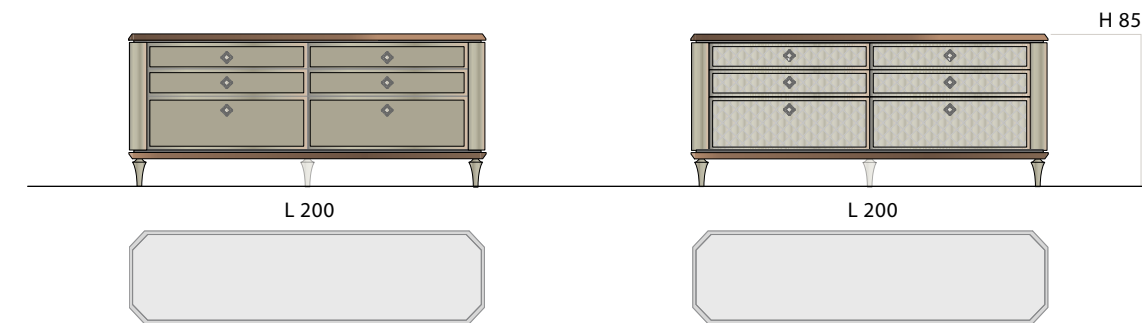

L 200

L 200

LISCIA OPACA smooth matt_COD. 1493
LISCIA LUCIDA smooth glossy_COD. 1748
MATELASSÈ OPACA matt_COD. 1588
MATELASSÈ LUCIDA glossy_COD. 1888
(Mobile a parete_Wall stand unit)

COMPLEMENTI NOTTE

night complements

Gamma di cassettiere, comodini, settimanali e complementi per la zona notte.
 La lastra inserita nel top con incavo è proposta in vetro liscio retrolaccato, a richiesta è possibile realizzare la lastra in marmo, o l'intero top in marmo, ad esclusione di comodini e settimanali dove il top è laccato.
 I cassetti sono in legno. I piedini, il basamento e il top con incavo sono disponibili in noce Canaletto, nero poro aperto o laccato. Disponibili nella profondità 52,9 e 62,5 cm.
 Range of chests of drawers, bedside, and complements for the bedroom.
 The slab inserted into the recessed top is available in rear-lacquered smooth glass, on request it is possible to realize the marble slab or the whole top in marble, with the exception of bedside and chests of seven drawers, where the top is lacquered. The drawers are made of wood. The feet, the base and the recessed top are available in Canaletto walnut, black open pore or lacquered. Available in cm 52,9 and 62,5 depth.

Riferimento pag. 52 / 64
 Page reference 52 / 64

LISCIO OPACO smooth matt
 L 45 COD. 290_L 60 COD. 331_L 90 COD. 419
 LISCIO LUCIDO smooth glossy
 L 45 COD. 325_L 60 COD. 370_L 90 COD. 469
 MATELASSÉ OPACO matt
 L 45 COD. 297_L 60 COD. 342_L 90 COD. 437
 MATELASSÉ LUCIDO glossy
 L 45 COD. 332_L 60 COD. 383_L 90 COD. 487
 (Mobile a parete_Wall stand unit)



Riferimento pag. 61 / 65
 Page reference 61 / 65

LISCIO OPACO smooth matt_COD. 1019
 LISCIO LUCIDO smooth glossy_COD. 1270
 MATELASSÉ OPACO matt_COD. 1065
 MATELASSÉ LUCIDO glossy_COD. 1380
 (Mobile a parete_Wall stand unit)

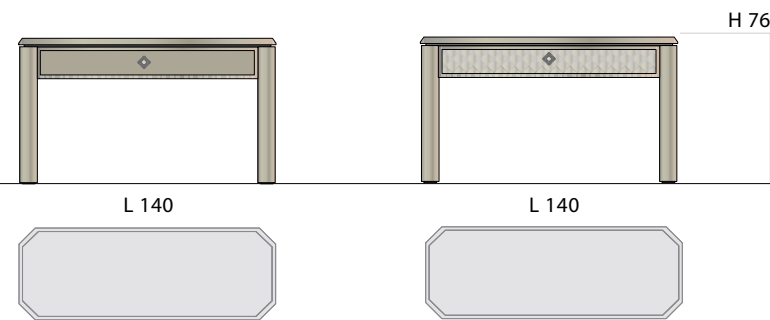

Riferimento pag. 52 / 65
 Page reference 52 / 65

P D 46,9/56,5
 COD. 650

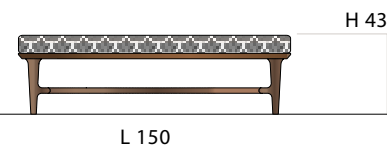

VANITY

bathroom

Le composizioni bagno sono dotate di lavabi a incasso sottotop o da appoggio in ceramica o vetro.
 Disponibili nella profondità 62,5 cm.
 Cassetti con guide Legrabox.
 Top bisellato in marmo classe 1.
 The bathroom composition feature undermount built-in or on top ceramic or glass wash basins. Legrabox drawers.
 Bevelled marble top class 1 Available in cm 62,5 depth.

Riferimento pag. 76 / 79
 Page reference 76 / 79

LISCIO OPACO smooth matt_COD. 1227
 LISCIO LUCIDO smooth glossy_COD. 1399
 MATELASSÉ OPACO matt_COD. 1265
 MATELASSÉ LUCIDO glossy_COD. 1432
 (Mobile a parete_Wall stand unit)



Riferimento pag. 73
 Page reference 73

LISCIO OPACO smooth matt_COD. 1388
 LISCIO LUCIDO smooth glossy_COD. 1578
 MATELASSÉ OPACO matt_COD. 1444
 MATELASSÉ LUCIDO glossy_COD. 1628
 (Mobile a parete_Wall stand unit)

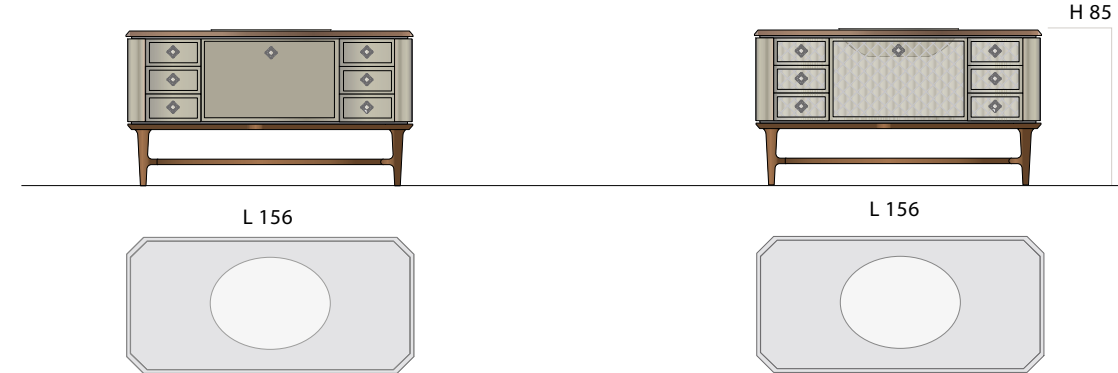

Riferimento pag. 75 / 80
 Page reference 75 / 80

LISCIO OPACO smooth matt_COD. 1720
 LISCIO LUCIDO smooth glossy_COD. 1943
 MATELASSÉ OPACO matt_COD. 1780
 MATELASSÉ LUCIDO glossy_COD. 1999
 (Mobile a parete_Wall stand unit)

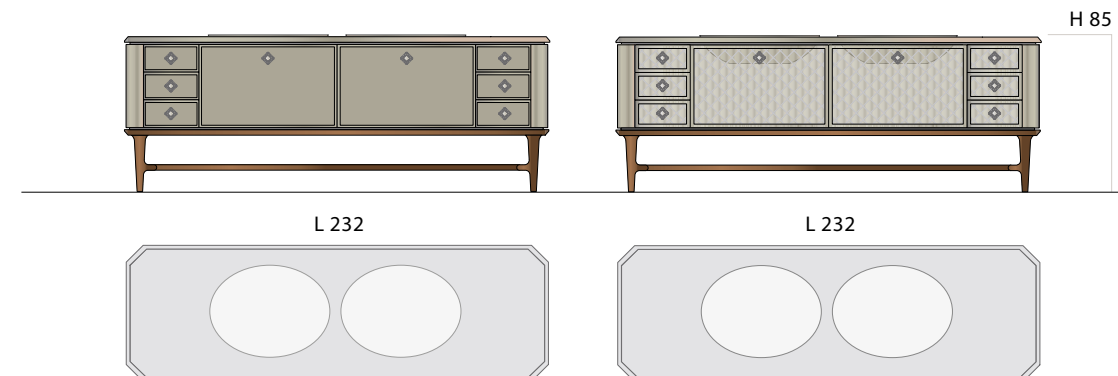

Le immagini e i colori dei prodotti stampati nel catalogo sono puramente indicativi
The images and the colours printed in this catalogue are purely for information

Tutti i diritti relativi ai contenuti e alle immagini riprodotti nel presente manuale
sono riservati. Ne è, pertanto, vietata la riproduzione, anche parziale, salvo espressa
autorizzazione scritta di SCIC spa

All rights relating to contents and images included in the present manual are reserved.
Therefore, any reproduction, even partial, is strictly forbidden, unless expressly authorised
in writing by SCIC S.p.A.



SCIC SpA - Via Cremonese, 135/A
43126 Viarolo, Parma - Italy
tel. +39 0521/6655
fax +39 0521/665566

staff@scic.it

scic.it